

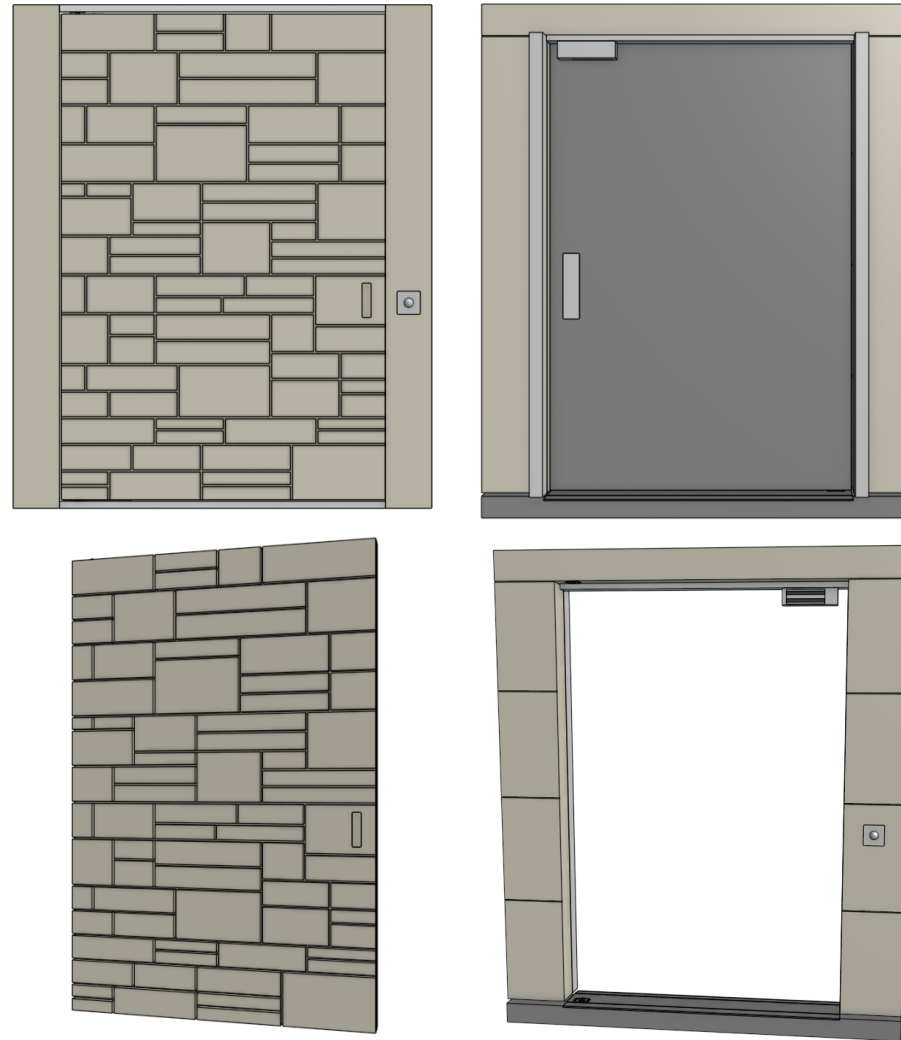

**OVERVIEW OF PIVOT DOOR DESIGN:**

- STONE CLAD PIVOT DOOR WITH OUTWARD OPENING ONLY
- DIMENSIONS 1.4M WIDTH X 2.1M HEIGHT
- APPROX. WEIGHT 200 - 250KG
- 25-30MM STONE SLICES EPOXIED TO MARINE PLY DOOR CORE WITH STEEL OUTER FRAME.
- CLIENT TO ISSUE LOCATION LABELLED STONE PANELS FOR MATCHING LAYOUT ON WALL.
- CLIENT TO FREE ISSUE EXISTING STONE PANELS. CRISTOFOLI TO MILL DOWN BACK FACE OF STONE TO APPROX. 25-30MM THICKNESS - SUBJECT TO TRIAL.
- PIVOT HINGE SELECTED WITH THE FOLLOWING FEATURES:
  - HOLD POSITION AT 90 DEG
  - WEIGHT CAPACITY OF 190-259KG
  - DAMPER CONTROL WITH ADJUSTABLE SOFT-CLOSE AND HYDRAULIC BACK-CHECK
  - 30 DEG SPEED CONTROL WITH ADJUSTABLE CLOSING SPEED IN THE LAST PART OF CLOSING MOVEMENT
  - TOP GAP OF 4-10MM
  - BOTTOM GAP OF 7MM
- STONE RECESSED PULL HANDLE TO OPEN DOOR FROM EXTERNAL SIDE - SUBJECT TO TRIAL OF SANDSTONE. MOST SUITABLE MAGLOCK ACCESS SYSTEM TO BE DETERMINED BY OTHERS E.G. KEYPAD / ACCESS CARD ENTRY ETC.
- ADDITIONAL TIMBER / STEEL REQUIRED ON INTERNAL SIDE OF DOOR HEADER FOR MAGLOCK FIXING.
- STAINLESS STEEL PUSH PLATE TO PUSH OPEN DOOR FROM INTERNAL SIDE. MAGLOCK ACCESS SYSTEM TO BE DETERMINED BY OTHERS.

**VISUALISATION OF STONE CLAD PIVOT DOOR**



UNLESS OTHERWISE SPECIFIED, DIMENSIONS ARE IN MILLIMETERS  ANGULAR = ± °  SURFACE FINISH ✓  DO NOT SCALE DRAWING  BREAK ALL SHARP EDGES AND REMOVE BURRS  FIRST ANGLE PROJECTION  	NAME	SIGNATURE	DATE	TITLE	
	DRAWN	CARA GARRAWAY	12/12/2025	EXTERNAL STONE CLAD DOOR - ROMAN BOND	
	CHECKED				
	APPROVED				
MATERIAL	FINISH		SIZE	DWG NO.	REV
			A4	ROMAN BOND DOOR-HEN001	01
SCALE			WEIGHT		SHEET
1:20					1 of 5

**STONE CLAD DOOR - DIMENSIONS & DETAILS**

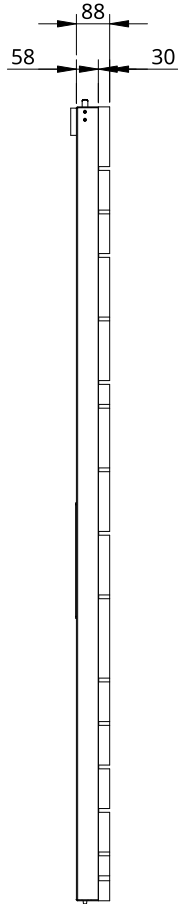
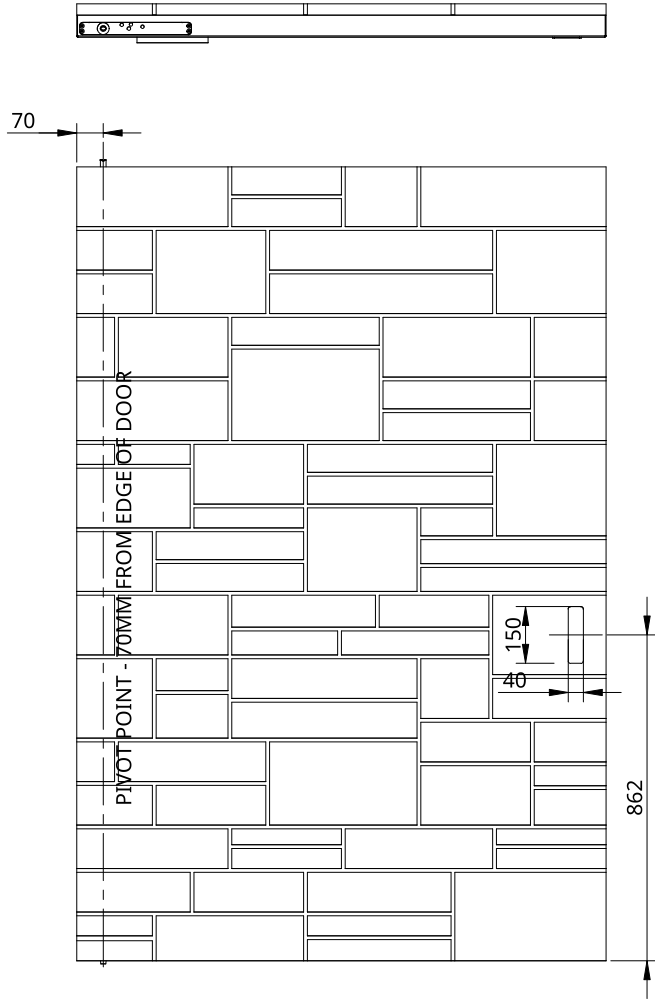

EPDM SEALS ON TOP OF DOOR AND EDGES OF DOOR TBC - NOT SHOWN ON DRAWING

MAGLOCK SYSTEM TO BE DETERMINED BY CLIENT

STAINLESS STEEL PUSH PLATE ON INSIDE FACE OF DOOR

BRUSH SEAL DRAFT EXCLUDER OR SIMILAR ON BOTTOM OF DOOR - NOT SHOWN ON DRAWING. REFER TO PAGE 5 FOR EXAMPLE LOCATION.

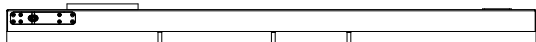
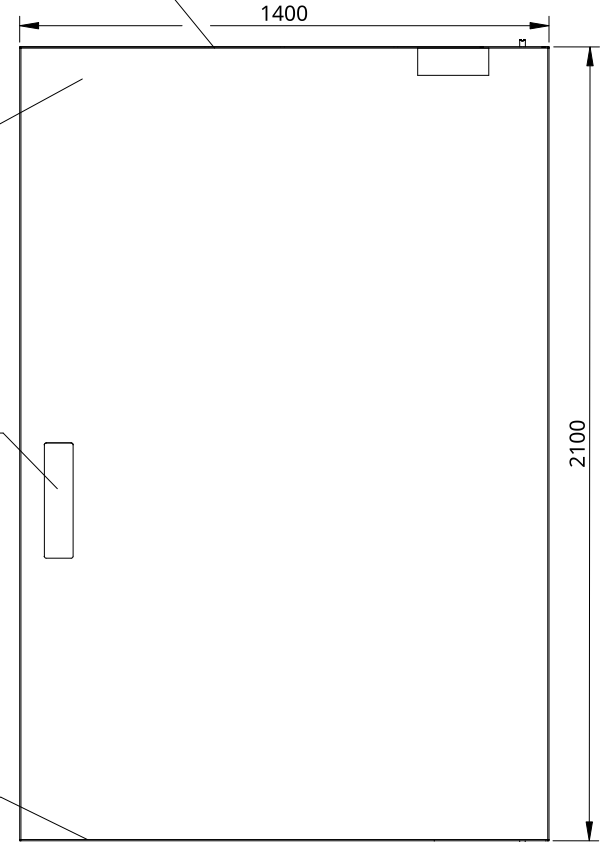

UNLESS OTHERWISE SPECIFIED, DIMENSIONS ARE IN MILLIMETERS ANGULAR = ±° SURFACE FINISH ✓ DO NOT SCALE DRAWING BREAK ALL SHARP EDGES AND REMOVE BURRS FIRST ANGLE PROJECTION	NAME	SIGNATURE	DATE	TITLE		
	DRAWN	CARA GARRAWAY	12/12/2025	EXTERNAL STONE CLAD DOOR - ROMAN BOND		
	CHECKED			<i>Cristofoli</i> INTERNATIONAL		
	APPROVED					
FIRST ANGLE PROJECTION	MATERIAL	FINISH		SIZE	DWG NO.	
				A4	ROMAN BOND DOOR-HEN001	
				SCALE	WEIGHT	SHEET
				1:20		2 of 5

**STONE CLAD DOOR - DIMENSIONS & DETAILS**

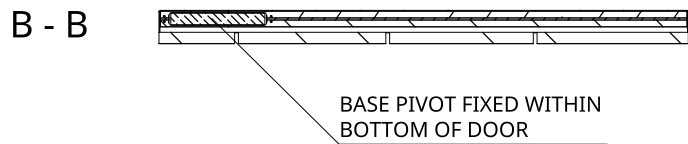
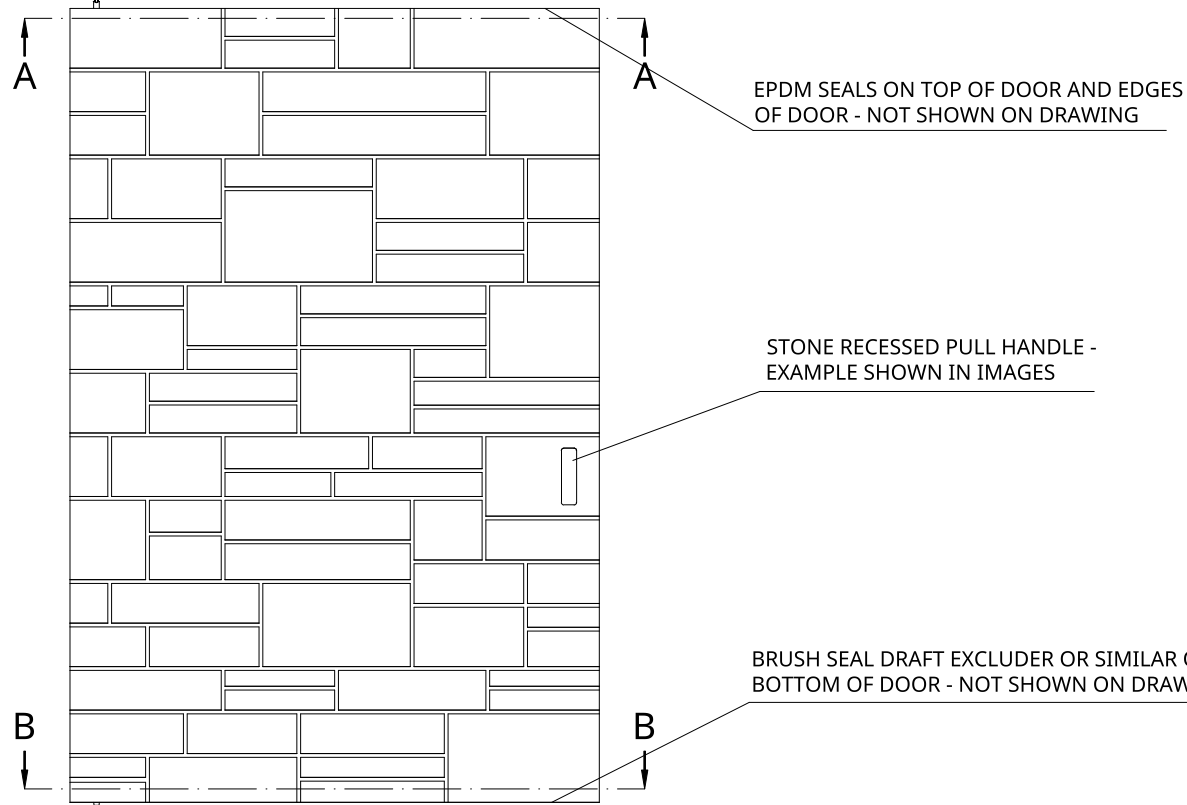

**RECESSED STONE PULL HANDLE EXAMPLE**



UNLESS OTHERWISE SPECIFIED, DIMENSIONS ARE IN MILLIMETERS		NAME	SIGNATURE	DATE	TITLE	
ANGULAR = ±°		DRAWN	CARA GARRAWAY	12/12/2025	EXTERNAL STONE CLAD DOOR - ROMAN BOND	
SURFACE FINISH ✓		CHECKED				
DO NOT SCALE DRAWING		APPROVED				
BREAK ALL SHARP EDGES AND REMOVE BURRS					SIZE	DWG NO.
FIRST ANGLE PROJECTION		MATERIAL		FINISH	A4	ROMAN BOND DOOR-HEN001
					SCALE	REV
					1:20	01
					WEIGHT	SHEET
						3 of 5

**DOOR SURROUND - DIMENSIONS & DETAILS**

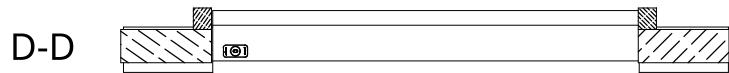
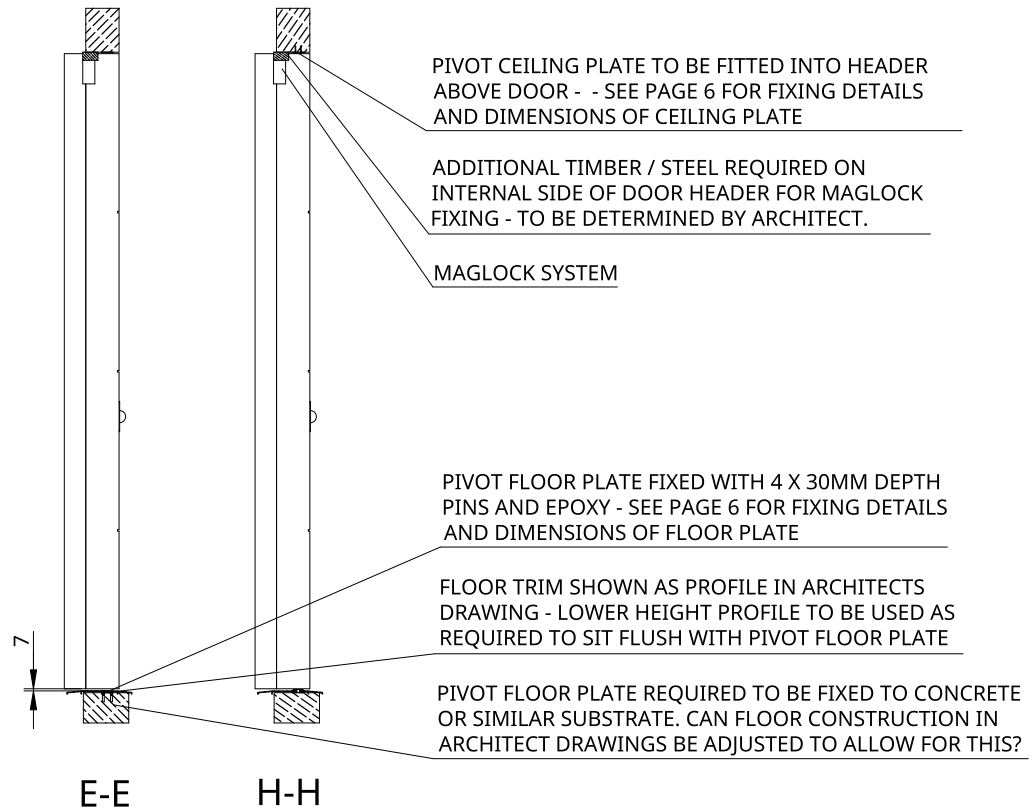
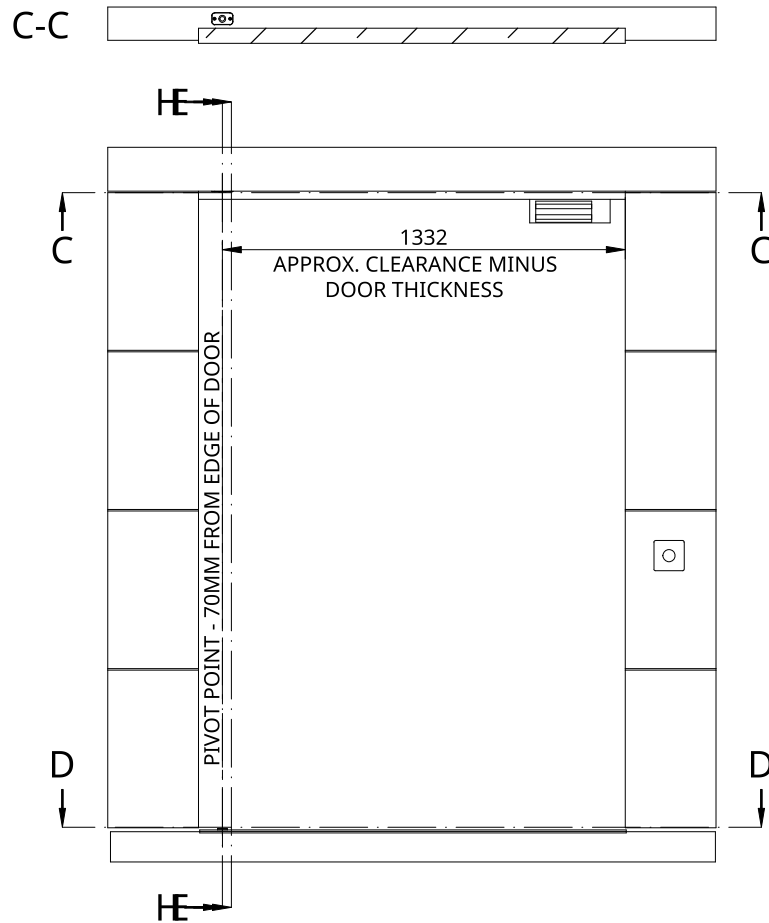

UNLESS OTHERWISE SPECIFIED, DIMENSIONS ARE IN MILLIMETERS  ANGULAR = ± °  SURFACE FINISH  DO NOT SCALE DRAWING  BREAK ALL SHARP EDGES AND REMOVE BURRS  FIRST ANGLE PROJECTION  	NAME	SIGNATURE	DATE	TITLE
	DRAWN	CARA GARRAWAY	2025-12-12	<b>EXTERNAL STONE CLAD DOOR -                  ROMAN BOND</b>   INTERNATIONAL
	CHECKED			
	APPROVED			
MATERIAL	FINISH		SIZE	DWG NO.
			<b>A4</b>	<b>ROMAN BOND DOOR-HEN001</b>
			SCALE	WEIGHT
			1:25	
			SHEET	REV.
			4 of 5	

**FLOOR PLATE DIMENSIONS**

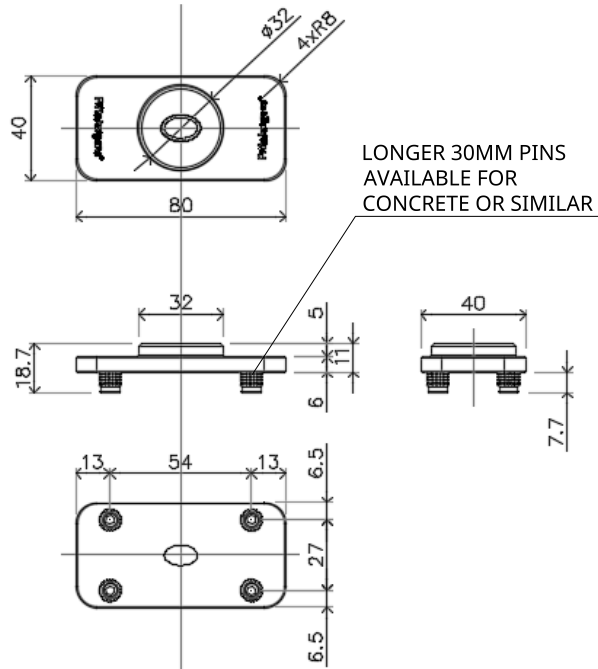

**CEILING PLATE DIMENSIONS**

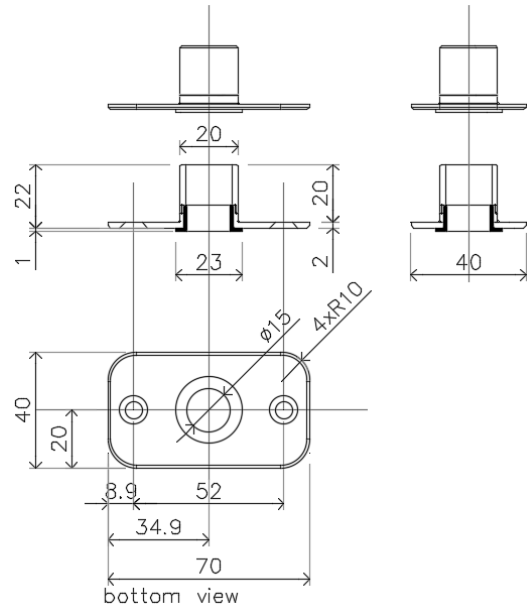

**PIVOT HINGE FLOOR SECTION VIEW**

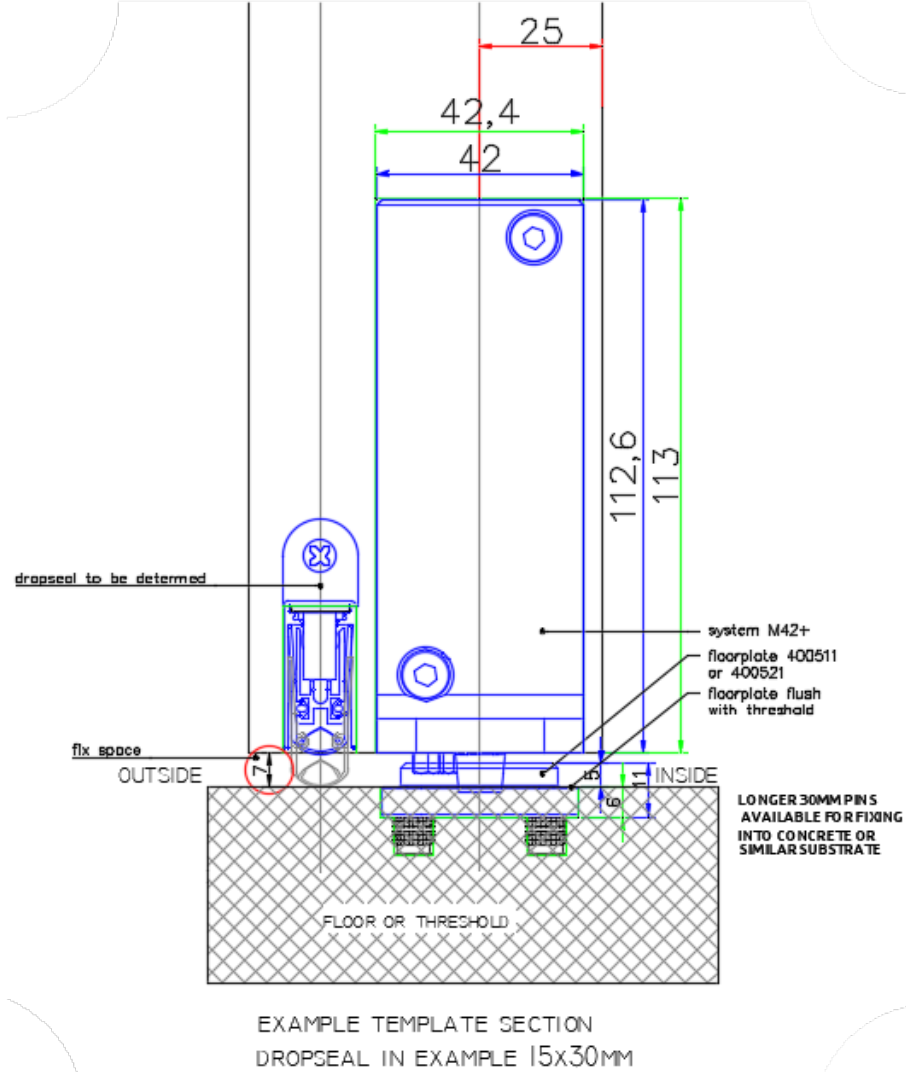

UNLESS OTHERWISE SPECIFIED, DIMENSIONS ARE IN MILLIMETERS

ANGULAR = ±°

SURFACE FINISH  $\sqrt{\quad}$

DO NOT SCALE DRAWING

BREAK ALL SHARP EDGES AND REMOVE BURRS

FIRST ANGLE PROJECTION



NAME	SIGNATURE	DATE
DRAWN	CARA GARRAWAY	2025-12-12
CHECKED		
APPROVED		

MATERIAL	FINISH
----------	--------

TITLE  
**EXTERNAL STONE CLAD DOOR - ROMAN BOND**

*Cristofoli*  
INTERNATIONAL

SIZE <b>A4</b>	DWG NO. <b>ROMAN BOND DOOR-HEN001</b>	REV.
-------------------	--	------

SCALE 1:25	WEIGHT	SHEET 5 of 5
---------------	--------	-----------------