

Scale 1:20

Subframe 90x60

125x56

Panels with timber Mouldings
Field and Reixed

200x56

200x56

30x90

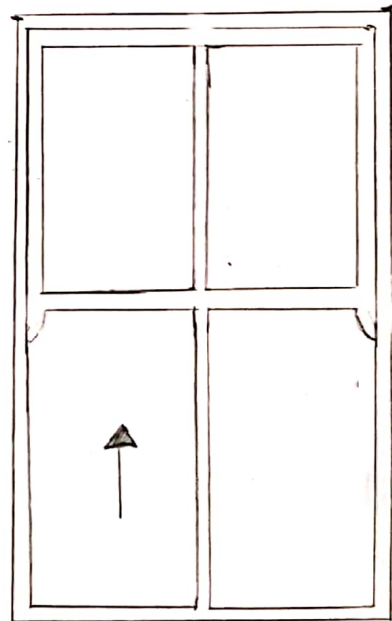
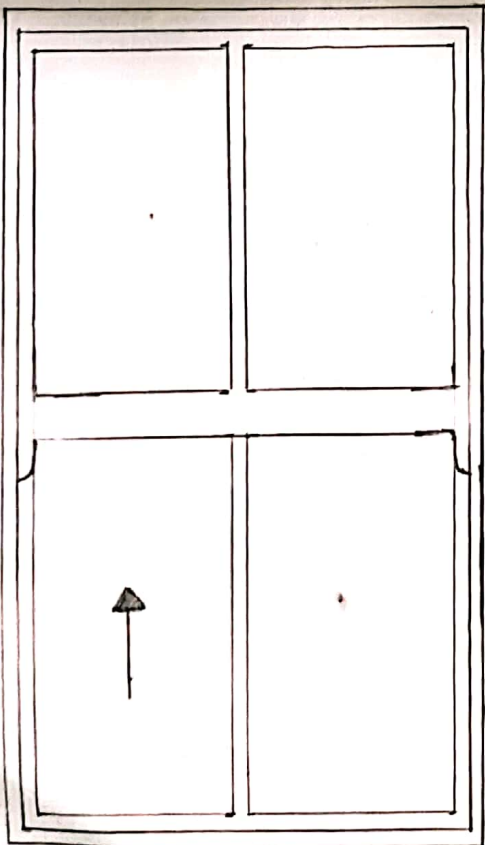

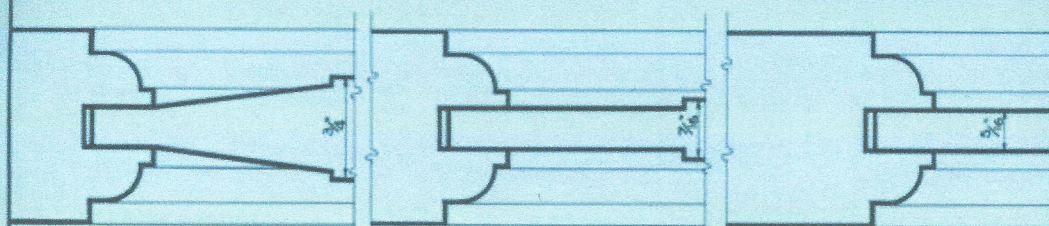

DOOR M-1050 DOOR M-1051 DOOR M-1052

FULL SIZE SECTIONS OF DOORS 1 3/8" THICK



DOOR M-1050

ALSO 2'-6", 2'-10", 3'-0" AND OTHER STANDARD STOCK SIZES

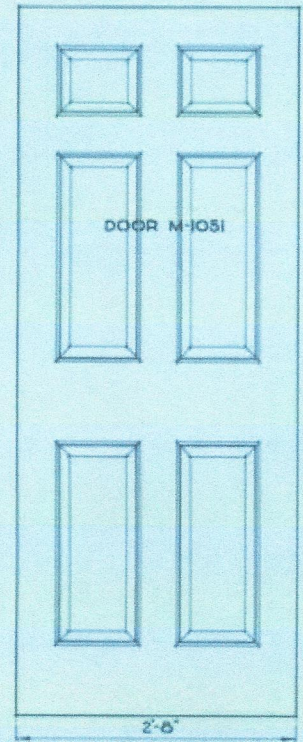

DOOR M-1051

ALSO 2'-4", 2'-10", 3'-0" AND OTHER STANDARD STOCK SIZES

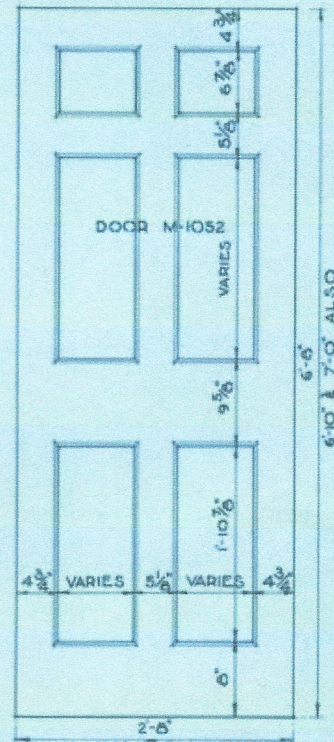

DOOR M-1052

ALSO 2'-6", 2'-10", 3'-0" AND OTHER STANDARD STOCK SIZES

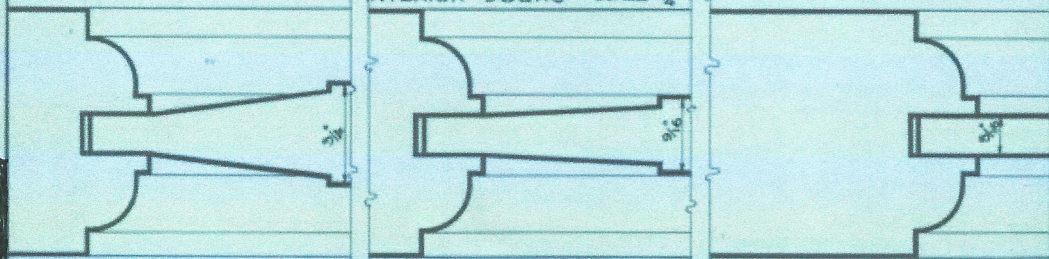

DOOR M-1050 DOOR M-1051 DOOR M-1052

FULL SIZE SECTIONS OF DOORS 1 3/4" THICK

6'-0" ALSO 7'-0" 6'-10"

INTERIOR DOORS SCALE 3/8" = 1'-0"

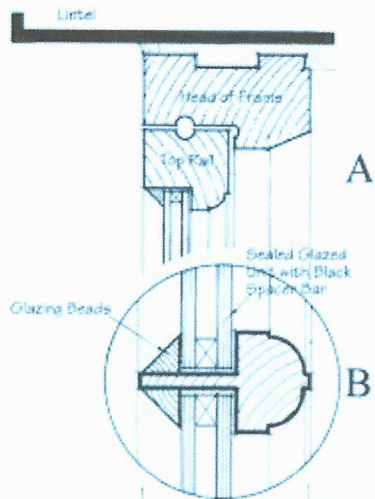

Window Section