

**PHASE 1
GEOTECHNICAL AND GEO-ENVIRONMENTAL
SITE INVESTIGATION**

**CLOUGH HOUSE, LEEDS ROAD,
BIRSTALL, BATLEY**

**FOR
ROSIE CARR**



44688-001

14 January 2020

**PHASE 1
GEOTECHNICAL AND GEO-ENVIRONMENTAL
SITE INVESTIGATION**

**CLOUGH HOUSE, LEEDS ROAD,
BIRSTALL, BATLEY**

FOR

ROSIE CARR

ISSUE 1

Job No. : 44688
Report Status : Issue 1
Document Date : 14 January 2020

REDACTED

Approved :
Catherine Topliss

CONTENTS

1.0	EXECUTIVE SUMMARY	5
2.0	INTRODUCTION.....	7
2.1	Terms of Reference	7
2.2	Context	7
2.3	Aims and Objectives	7
2.4	Scope of Investigation.....	7
2.5	Limitations of Investigation	8
3.0	THE SITE.....	9
3.1	Description.....	9
3.2	History.....	9
3.3	Geology	12
3.4	Hydrogeology.....	12
3.5	Hydrology.....	12
3.6	Coal Mining.....	13
3.7	Ground Gas	15
3.8	Pollution Incidents to Controlled Waters.....	16
3.9	Discharge Consents.....	16
3.10	Flooding.....	17
3.11	Soil Geochemistry.....	17
4.0	EXPECTED GROUND CONDITIONS.....	18
4.1	Surface Covering	18
4.2	Made Ground.....	18
4.3	Natural Ground	18
4.4	Groundwater	18
5.0	OUTLINE CONCEPTUAL MODEL.....	19
5.1	Potential Sources of Contamination	19
5.2	Ground Gas	19
5.3	Potential Pollutant Linkages	20
5.4	Remedial Measures	20

6.0	GEOTECHNICAL APPRAISAL	21
6.1	General	21
6.2	Foundations	21
6.3	Ground Slabs	22
6.4	Superstructure Precautions	22
6.5	Excavation Problems	22
6.6	Obstructions	23
6.7	Roads	23
6.8	Surface Water Drainage	23
7.0	RECOMMENDATIONS FOR FURTHER WORK	24

APPENDIX

Site Photographs

Envirocheck

Consultants Coal Mining Report

1.0 EXECUTIVE SUMMARY

1. The nearly one hectare site is located north of Leeds Road in the east of Birstall, around 9.5 km south west of Leeds city centre. The site currently comprises Clough House and two outbuildings in the centre of the site with soft landscaping to the north and south. Localised areas of macadam and concrete hardstanding exist in the centre and south of the site.
2. Historically a railway cutting crossed through the north of the site, trending roughly east to west, which was backfilled prior to 1986. Anecdotal evidence suggests the northern half of the site was utilised as a pig farm prior to the 1990s, which comprised various large buildings and a tank. A well and pump are expected in the central east and west of the site, respectively.
3. The highest point is in the north western corner at around 151 m AOD sloping down to Leeds Road at around 144 m AOD, with a small relatively level plateau surrounding Clough House. An approximate gradient of 1 in 24 is calculated from north to south across the site.
4. The geological map indicates the majority of the site to be underlain by undifferentiated shales and mudstones of the Pennine Middle Coal Measures Formation and a band of sandstone (Emley Rock) crosses the centre of the site.
5. The area surrounding the site is highly faulted and three faults are recorded to cross the site at surface.
6. Two coal seams are recorded to outcrop onsite. Shallow coal workings may be present and a rotary investigation is considered necessary to confirm if drilling and grouting is required, although this is considered unlikely.
7. No radon precautions are required. Deep made is expected onsite, as well as possible backfilled features and possible shallow coal mining. Three areas of infilled ground and five areas of potentially infilled land relating to water are recorded within 250 m. A gas monitoring programme is recommended, and at this stage that Amber 1 precautions be allowed for across 80% of plots and Amber 2 for around 20%.
8. Made ground is expected across the northern half of the site and is expected to reach significant depth within the former railway cutting, and as a result of the cellar below Clough House and former buildings. Natural weathered mudstone (clay), shale (clay) and sandstone (sand) are expected at shallow depth below the site.
9. Shallow groundwater is not expected below the site.

10. Strip or trench fill foundations are expected to be the most appropriate foundation solution across the majority of the site, taken through any made ground into undisturbed non-desiccated natural ground at a minimum depth of 900 mm in clay soil or 600 to 750 mm in granular soils. No plots appear to be located within the former railway cutting, if plots are proposed here in the future piles would likely be required.
11. The stability of trenches may be poor in made ground, especially if perched groundwater is encountered. Obstructions, such as old foundations and slabs as a result of former infrastructure are expected below the site.
12. Soakaways may be viable in a small portion of the site.
13. A capping layer, with a minimum thickness of 600 mm, including 100 mm of topsoil, over made ground should be allowed for in gardens and landscaped areas in the northern half of the site.
14. At this stage we recommend DS-2 AC-2 sulphate precautions be allowed for below ground concrete in contact with made ground, and protective water supply pipes in made ground.
15. Before more definite information regarding the properties of the ground and any contamination present can be given, an intrusive ground investigation will be required.

2.0 INTRODUCTION

2.1 Terms of Reference

This report presents the findings of a Phase 1 geotechnical and geo-environmental site investigation carried out by Eastwood & Partners (Consulting Engineers) Limited for, and on the instructions of Rosie Carr. Any other parties using the information in this report do so at their own risk and any duty of care is excluded.

2.2 Context

Eastwood & Partners are not aware of any previous investigations having been undertaken on the site.

2.3 Aims and Objectives

The aims and objectives of this investigation were as follows:

- To assimilate and review information extracted from published documentation to derive an outline conceptual model identifying potential contaminants, pathways and receptors, as well as possible linkages between these;
- To detail the expected ground conditions and their geotechnical properties enabling outline foundation proposals to be made for the proposed residential development; and
- To outline proposals for a Phase 2 intrusive investigation, the purpose of which would be to obtain information to test the conceptual model and assess the risks to receptors as well as to confirm the foundation proposals.

2.4 Scope of Investigation

This document constitutes the findings of the Phase 1 investigation. This involved a review of information extracted from published documentation. Information regarding the current and former land uses both on and surrounding the site, as well as the environmental sensitivity of the location as determined by factors including geology, hydrogeology and hydrology have been examined.

Information analysed has been obtained from a variety of sources and included the following:

- A Landmark Envirocheck;
- The British Geological Survey online viewer, geological maps and associated memoirs;
- The Coal Authority online viewer;
- A Consultants Coal Mining Report; and

- A site walkover.

2.5 Limitations of Investigation

This report is based on the assumption that the site will be developed with housing of conventional construction, with private gardens and areas of public open space. It is assumed site levels will remain relatively unchanged. If this is not the case, then the advice given in this report may not be appropriate.

Where assessments of site areas affected in particular ways are given, these are approximate. All information, comments and opinions given in this report are based on the documentary information examined. This report considers the ground and groundwater and does not cover any buildings or their fabric or the constituents of any existing hardstanding. Risks to ecological receptors, such as bats, have not been considered.

3.0 THE SITE

3.1 Description

The approximately 0.9 hectare site is located directly north of Leeds Road in the east of Birstall, around 9.5 km south west of Leeds city centre. It is roughly rectangular in shape on plan and is centred around grid reference 423390, 426680.

The site slopes gently from around 151 m in the north western corner down to around 144 m at the southern boundary. An approximate gradient of 1 in 24 is calculated north to south across the site, although localised steeper slopes were observed. A relatively level plateau was noted around Clough House and the ground level around the outbuildings was noted to be around 0.5 m lower than Moat Hill Farm Drive directly west of the boundary.

The majority of the site has comprised a private residence, Clough House, since 1864 which is still present in the centre of the site today. Anecdotal evidence suggests a cellar underlies around a third of the house footprint. Two outbuildings, which formed part of a former pig farm, remain to the north of the main house.

Minimal development has occurred in the southern half of the site. It is currently primarily surfaced with soft landscaping and a looped macadam entrance extends from Leeds Road up to the front of the main house. Localised hardstanding is also present between Clough House and the outbuildings to the north.

Tree stumps line the edge of the looped entrance in the south of the site and aerial imagery from 2015 shows mature trees to line the southern site boundary which were not observed during the walkover. Sporadic trees remain in the south west and central east of the site.

An enclosed garden is present to the east of the house, bound by a stone wall to the north and a hedgerow to the south.

Photographs from the walkover are included in the Appendix.

3.2 History

Historical Ordnance Survey maps have been reviewed in the Envirocheck to assess the previous use of the site and surrounding area. The maps, together with the Envirocheck, can be found in the Appendix.

3.2.1 The Site

The earliest Ordnance Survey map available to view, dated 1854, shows Clough House in the central west of the site with two smaller outbuildings to the north. A possible boundary fence or wall

curves from the rear of the house across the site to the eastern boundary. A field boundary segregates a small portion in the north from the remainder of the site, this area appears to be part of a larger agricultural field extending north. Various trees are shown in the southern half of the site, along the western boundary and along the field boundary in the north.

The more detailed (1:2,500 scale) map dated 1893 to 1894 indicates a pump is located between Clough House and one of the outbuildings in the west of the site. A well is also located along the eastern boundary.

Part of a railway cutting (Heaton Lodge & Wortley Line) is shown to cross the northern edge of the site, sloping down to the north, by 1907 to 1908. The well in the east of the site is no longer mapped at this time.

By 1922 the pump is no longer mapped. The number of trees in the south of the site has been reduced, leaving a row lining the southern boundary and along the circular track leading to the house.

The easternmost outbuilding has been demolished by 1933.

At least six large rectangular buildings have been constructed between Clough House and the top of the railway cutting by 1971. The remaining outbuilding has been replaced and incorporated into this new development. Anecdotal evidence suggests these buildings could have been related to pig farming. Tanks are shown adjacent to one of these larger buildings close to the western boundary. A smaller building is constructed in the central east of the site, south of the fence/wall line. The railway directly north of the site has been labelled as dismantled, the cutting remains in place.

The cutting in the north of the site is no longer mapped by 1986 indicating landscaping or backfilling may have taken place.

The majority of the larger buildings in the northern half of the site, suspected to be associated with pig farming, are demolished by 1990. Two buildings remain in this area until 1991 when an additional building is constructed adjacent to the western boundary. The smaller building in the east of the site has been demolished.

No significant changes are then noted on subsequent maps, or on aerial photography dated between 2002 and 2019, although a large marquee is identified in the north of the site on the 2015 aerial photograph.

3.2.2 The Surrounding Area

The earliest map, dated 1854, generally shows the surrounding area to comprise agricultural land. Leeds Road is shown in its current day location parallel to the southern site boundary. A row of

housing is mapped directly east of the site along Leeds Road and a cluster of buildings, labelled as Moat Hill, are shown directly west of the site. A railway line is shown to trend roughly north to south approximately 300 m east of the site. Several coal pits are mapped between 230 and 500 m north east of the site. The town centre of Birstall is around 750 m south west and a large sandstone quarry (Brown Hill Quarry) is located around 675 m south west. Boggard Colliery and associated coal pits are mapped between 550 and 600 m south east of the site and Birstall Colliery is around 350 m north west.

Boggard and Birstall Collieries are no longer mapped by 1894 to 1895. The coal pits to the north east of the site are no longer shown, replaced instead by an unnamed colliery which appears to have expanded to within 350 m of the site boundary. Old shafts are mapped around 400 m east of the boundary. Buildings are shown to line Leeds Road coming within 110 m of the western site boundary. A pond and a well are mapped 140 and 160 m east of the site, respectively.

The 1908 map shows the colliery to the north east as Howden Clough Colliery. Several associated railway sidings are shown to branch off the main train line extending within 300 m of the boundary. Brownhill Quarry is labelled as disused. A new air shaft has been excavated east of some old shafts, approximately 650 m east of the boundary.

Howden Clough Colliery has expanded west by 1932. The well located beyond the pond to the east of the site is no longer mapped. Two rows of housing have been constructed directly west of the site boundary. The air shaft is no longer mapped.

Howden Clough Colliery is labelled as disused by 1955; the associated railway sidings have been demolished but the buildings and colliery spoil are still present.

Residential properties are constructed directly east of the northern half of the site by 1971 and the majority of the surrounding area to the south and west has been built up connecting to Birstall. The railway line to the north of the site has been dismantled, and is labelled as a path/track. The railway to the east of the site has also been dismantled. The infrastructure associated with Howden Clough Colliery has been dismantled and a depot has been constructed in its footprint.

The section of the embankment which crossed within the northern site boundary has been potentially infilled together with a stretch to the east and west of the site by 1986.

An industrial estate has been constructed in the location of the former railway line to the north of the site and beyond by 1991. A possible drain is shown around 100 m north east of the site, later labelled as a drain and flood tank.

No other significant developments are noted on subsequent maps.

3.3 Geology

The geological map for the area, 232 NE (1:10,560 scale) shows the centre of the site to be underlain by sandstone of the Pennine Middle Coal Measures Formation. The local geological memoir for the area (Geology of Huddersfield and Halifax) refers to this sandstone unit as Emley Rock.

Undifferentiated shales or mudstones of the Pennine Middle Coal Measures Formation are present in the north and south of the site.

No superficial deposits are shown to overlie the site.

A fault is shown to cross the southern half of the site at surface, orientated roughly east to west and downthrown to the south. An inferred fault is shown to cross the north western tip of the site, orientated north east to south west and downthrown to the south east. A further fault is recorded within the Middleton coal at depth across the southern tip of the site.

Within the area to the south of the faults and in the fault blocks east and west of the site, the strata are recorded to dip to the north east between 1 and 3°. There is no available data for the strata within the fault block surrounding the site therefore the dip and direction of the beds is unknown.

The Adwalton Stone Coal is inferred to outcrop across the southern third of the site, orientated roughly north east to south west and is expected to be present below the site at shallow depth. A second seam, the Adwalton Black Bed is stratigraphically older and was observed at outcrop in the former railway cutting in the north of the site.

3.4 Hydrogeology

The Envirocheck identifies the underlying bedrock as a Secondary A Aquifer. The Environment Agency defines these as permeable layers capable of supporting water supplies at a local rather than strategic scale, and in some cases forming an important source of base flow to rivers.

The site is not situated within a Groundwater Source Protection Zone.

There are no groundwater abstractions located within 250 m of the site.

3.5 Hydrology

According to the Envirocheck, the nearest surface water feature is located 101 m north east. This is expected to relate to a short section of drain, approximately 78 m long, which is labelled as part of a flood tank on an industrial estate.

3.6 Coal Mining

The historical map review identified several collieries and coal pits surrounding the site. Howden Clough Colliery was the longest operating colliery in closest proximity to the site, located around 350 m north east between 1908 and 1955.

The geological map for the area shows the Adwalton Stone Coal inferred to outcrop across the southern third of the site and is the shallowest expected seam below the site. The local memoir notes this seam is also referred to as the Flockton Thick Coal and the Carbonicola band sits just above it. In this geographical area the coal consists of three divisions, a bed of stone coal at the top (0.15 to 0.4 m), resting on the 'Middle Bed' (0.12 to 0.35 m), which is separated from the 'Low bed' (0.25 to 0.45 m) by a 0.02 to 0.22 m thick dirt parting. Records indicate the seam has mainly been worked from bell pits or pits around Flockton.

The second shallowest seam expected below the site is the Adwalton Black Bed which has been observed at outcrop in the former railway cutting in the north of the site. The seam is expected at shallow depth below the site excluding the area within the railway cutting in the north. The local geological memoir notes this seam is also referred to as the Flockton Thin Coal. The seam is recorded to be of good quality with a dull lustre in the north east, and is of significant thickness. Therefore, it has been largely worked and little remains. The seam has a local recorded thickness of 0.86 m, with a thin dirt parting about 0.1 m from the top.

Stratigraphically, the next shallowest coal beneath the site is the Brown Metal Coals, also referred to as the Old Hard Coals, and in areas is split into three leaves. The geological memoir states the split between the shallower 1st and 2nd coals occurs east of a line through Howden Clough therefore the parting between these coals is not expected to be significant below the site. In the area around Adwalton, around 1.7 km north of the site, the coal is recorded to vary between 1.6 and 1.7 m thick with 0.35 to 0.45 m of dirt. Due to the high degree of faulting in the surrounding area there is no visible outcrop to estimate the depth to the seams and the overlying Birstall Rock is known to vary significantly in thickness. None of the borehole records available online or the annotations on the geological map in the vicinity of the site record the presence of the Brown Metal Coals which could indicate they are were not widely extracted in the region.

Coal Authority Mining Report

The Envirocheck indicates the site is located in an area which may be affected by coal mining activity. A Coal Authority Consultants Mining Report has therefore been obtained, a copy of which is in the Appendix.

The Coal Authority states the site is within the likely zone of influence from subsurface workings in four seams of coal between 36 and 233 m depth. The seams are named as the Flockton Thin (Adwalton Black Bed), Middleton Main, Whinmoor and Black Bed, last worked in 1927.

Unrecorded shallow workings are considered likely. This is most likely associated with the Adwalton Stone Coal (Flockton Thick) and Adwalton Black Bed (Flockton Thin) which are both shown to outcrop on the site. Both seams are considered to be workable; the Adwalton Stone Coal outcrop has a bearing of 241° and the Adwalton Black Bed of 91° which are displayed on the summary of findings map, an extract of which is below.

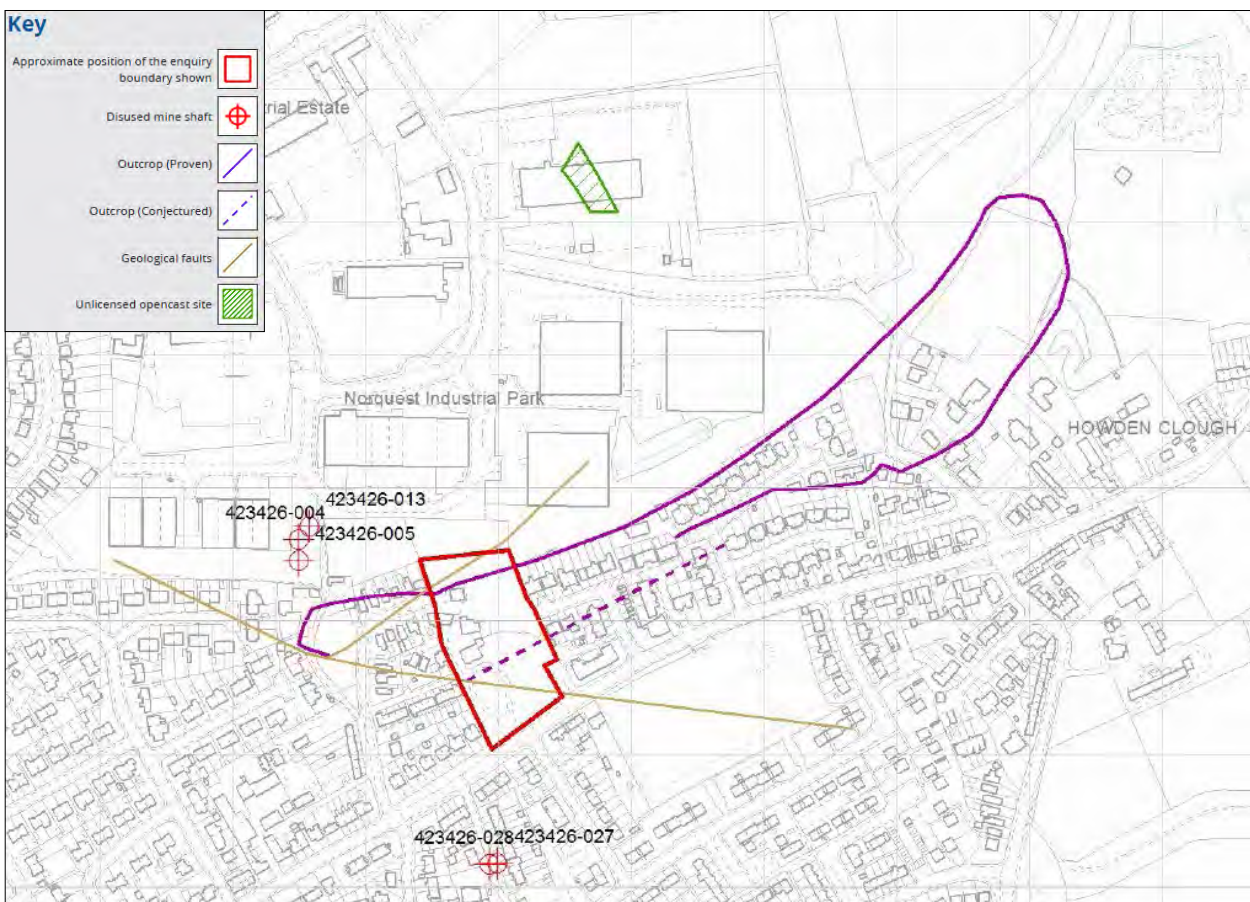

Two faults are recorded to cross the site according to the Coal Authority; their approximate positions have also been outlined on the above plan in yellow.

Five known mine entries are located within close proximity to the site, their positions are shown on the plan above. The possibility of unrecorded entries cannot be discounted.

The Coal Authority has no record of any future underground mining and there are no current coal mining licenses within 200 m of the site boundary.

There are no records of any mine gas emissions requiring action.

The Coal Authority has not received any damage notices or claims for the site, or any property within 50 m of the boundary, relating to subsidence since 31 October 1994. No Section 46 notices have been given stating the land is at risk of coal mining related subsidence.

The site is not in an area where a notice to withdraw support has been given.

It is possible that while creating the railway cutting the Adwalton Black Coal was extracted from outcrop below the site. Extraction of the Adwalton Stone coal could also have been undertaken prior to the construction of Clough House, possibly via bell pits. Therefore, the presence of shallow workings cannot be fully discounted at this stage.

Due to the outcropping coal seams on, and in the vicinity of the site (north and north west), it is considered shallow coal workings may be present below the site. According to the Coal Authority Online Viewer there are probable shallow coal workings below the site and it is situated within a development high risk area. It is therefore considered prudent to undertake a borehole investigation to confirm the depth to, thickness and condition of the shallow coal seams below the site and to determine if any remedial works are required.

3.7 Ground Gas

The site is not located within a radon affected area according to the Envirocheck, therefore no radon protective measures are required.

Shallow coal workings may be present beneath the site; consequently there could be a risk of mine gas generation.

Made ground is expected across the northern half of the site as a result of past development. However, it is only expected to extend to significant depth (greater than 2 m) within the footprint of the former railway cutting which was backfilled prior to 1986. The existing Clough House is expected to have a cellar which spans around a third of the footprint of the property, therefore should this structure be removed, consideration should be given to the suitability of the backfill material used.

A pump and a well were identified to be onsite during the historical map review. If either of these have been backfilled they are a potential source of ground gas. However, any ground gas generated would not be expected to affect a significant lateral area due to the anticipated small size of these features.

Other onsite sources of ground gas could be localised hotspots of contamination. Tanks are shown on historical maps in the north of the site from 1971 until their removal prior to 1990. Due to the reported former use of the site as a pig farm, these would be expected to be water tanks. However,

if they were fuel tanks, hydrocarbon impacted ground is a possibility and volatile hydrocarbons may pose a risk to the development.

The Envirocheck states there is one recorded historical landfill located within 250 m of the site and it is located within the site boundary. The license is for Moat Hill Farm and specifically covers the railway cutting which used to pass through the north of the site. Deposited waste included inert, industrial and commercial waste. Records state material was inputted from December 1978 to December 1988.

Records state there are three areas of potentially infilled land relating to non-water features within 250 m of the boundary. These are located between 212 and 235 m north and north east of the site and are all thought to be related to former coal pits shown on historical mapping.

There are five recorded potentially infilled areas of ground relating to water within 250 m of the site. The location of each feature has been identified on historical maps and the table below outlines the location and date of each feature.

Location (m)	Feature	Date of Potential Backfill
116 W	Pond at Moat Hill Farm	C. 1976
131 E	Possible pond	C. 1956
145 E	Pond	C. 1956
197 S	Pond	C. 1971
209 NE	Pond	C. 1956

These are not expected to present a significant risk of gas generation and migration.

A programme of gas monitoring will however, be required to assess the gassing regime at the site and determine the level of protection measures, if any, required for the proposed development.

3.8 Pollution Incidents to Controlled Waters

The Envirocheck holds one record for a pollution incident relating to controlled waters within 250 m of the site. The incident occurred on 2 July 1989, 160 m north west of the site, at the Mouth / Scotia Beck. It involved a foul sewer and the release of unknown chemicals into a freshwater stream/river. It was classified as a Category 2 Significant Incident. No easy pathway exists between the incident location and the site and due to the length of time elapsed since the incident any resulting contamination from this event is not considered to pose a significant risk.

3.9 Discharge Consents

According to the Envirocheck there are no discharge consents within 500 m of the site.

3.10 Flooding

The Envirocheck shows that the site is not within the floodplain of any rivers or seas and there is no significant risk of surface water flooding. There is however, limited potential for groundwater flooding to occur across the site.

3.11 Soil Geochemistry

The Envirocheck estimates the following concentrations of arsenic, cadmium, chromium, nickel and lead to be present in the natural soil at the site:

Contaminant	Estimated Concentration (mg/kg)	Assessment Value (mg/kg)
Arsenic	25 to 35	37
Cadmium	<1.8	11
Chromium	60 to 120	910
Lead	<100	200
Nickel	15 to 45	180

None of the contaminant concentrations are expected to be elevated within the natural ground.

4.0 EXPECTED GROUND CONDITIONS

4.1 Surface Covering

The majority of the site is surfaced with soft landscaping, therefore topsoil is expected from surface with localised areas of hardstanding (concrete and macadam). Three buildings, including Clough House, are located in the central west of the site.

4.2 Made Ground

Made ground is anticipated to be present across the majority of the northern half of the site, and is expected to extend to significant depth below a third of the house footprint as a result of the cellar, in the former railway embankment and potentially below former buildings.

Historically, a pump and a well are recorded to have been present onsite, these could have been backfilled resulting in a significant depth of made ground locally.

4.3 Natural Ground

Beneath the surface cover and made ground, the natural ground is expected to consist of clay over mudstone and shale, with a band of sand over sandstone across the centre of the site.

Shallow coal may be encountered below the site.

4.4 Groundwater

Shallow groundwater is not expected to be present below the site.

Made ground is expected across the site and perched groundwater may be encountered.

5.0 OUTLINE CONCEPTUAL MODEL

The site is being considered for low-rise housing of conventional construction with private gardens and associated areas of soft landscaping and hardstanding. It is understood the current buildings onsite, including Clough House, will be demolished prior to development.

5.1 Potential Sources of Contamination

Topsoil is expected below grass cover across the majority of the southern half of the site. Made ground is expected to be present below the surface covering in the north of the site as a result of previous development and the infilling of a railway cutting (historic landfill). Any made ground may contain some elevated concentrations of heavy metals / metalloids such as arsenic, lead, nickel, copper or zinc, as well as elevated concentrations of polycyclic aromatic hydrocarbons (PAHs), particularly if ashy materials are present, and sulphates. Asbestos may also be present in the made ground.

The historical map review highlighted the presence of tanks in the north of the site. The purpose of these tanks is unknown, but if they did contain hydrocarbon-based products, elevated levels of petroleum hydrocarbons may be locally present.

5.2 Ground Gas

No radon protective measures are required.

Deep made ground is expected onsite within the backfilled railway cutting, which is also recorded as a historical landfill, and may also be present below former buildings and the existing Clough House which contains a cellar. Historically, a well and pump have been onsite which could have been backfilled and are therefore potentially a more localised source of ground gas.

Due to historical land uses localised contamination onsite may include volatiles which could require protective measures in overlying plots. This is not expected to affect a significant proportion of the site.

There are three recorded infilled areas of ground and five recorded areas of potentially infilled land relating to water within 250 m of the boundary.

If shallow coal workings exist beneath the site they are a possible source of mine gas which could migrate to surface.

A ground gas monitoring programme will be required to establish the level of gas precautions necessary. At this stage, we recommend that you assume Amber 1 precautions are required for

around 80% of the site, with the remaining 20%, i.e. in plots directly over the historical landfill and any hotspots of volatile contamination, requiring Amber 2 precautions.

5.3 Potential Pollutant Linkages

The table below details the possible sources and associated contaminants of concern, pathways and receptors:

Source	Potential Contaminants	Potential Pathways	Potential Receptors
Made ground/current and former use of the site	Heavy metals/metalloids PAHs Asbestos Sulphates	Ingestion, inhalation, direct contact	Future residents and visitors to the site Site construction workers Plants
		Direct contact	Below ground concrete
		Migration through ground	Secondary A Aquifer
Old tanks	Petroleum hydrocarbons	Direct contact	Water supply pipes
Onsite landfill / infilled cutting Backfilled well and pump onsite Possible shallow mine workings Infilled ground offsite	Ground gas	Migration through ground, inhalation	Future residents and visitors to the site Site construction workers Buildings

5.4 Remedial Measures

The following remedial measures should be allowed for:

- A minimum 600 mm thick clean capping, including 100 mm of topsoil, for all gardens and landscaped areas in the northern half of the site. This may need to be increased to 1000 mm if coal seams outcrop beneath garden and landscaped areas to mitigate combustion risks*;
- Remediation or removal of localised hotspots of hydrocarbon impacted soils (e.g. associated with former tanks) although this is considered unlikely;
- If significant asbestos containing material is present, it may need to be removed by a specialist contractor;
- A minimum DS-2 AC-2 level of sulphate precautions, applying to below ground concrete structures within contact of made ground;
- Suitably resistive water supply pipes in made ground; and
- A gas monitoring programme to establish the gas regime of the site. At this stage, we recommend assuming that Amber 1 gas precautions are required for around 80% of the site, and Amber 2 precautions for the remaining 20% of the site.

*Potential heat sources, such as electricity cables should also not be laid in contact with coal.

6.0 GEOTECHNICAL APPRAISAL

6.1 General

Made ground is expected across the northern half of the site as a result of previous development. Deep made ground may be present below existing buildings and is expected within the extent of the backfilled railway cutting.

Below made ground, or below the surface covering in the southern half of the site, clay over mudstone or shale is expected with a band of sand over sandstone in the centre of the site. Shallow bedrock is expected.

Shallow groundwater is not expected at shallow depth beneath the site.

Shallow coal workings may be present below the site. A drilling investigation is required to confirm this. Drilling and grouting could be required but is considered unlikely.

The site slopes down to Leeds Road on the southern boundary at an approximate gradient of around 1 in 24. The ground level of site was noted to be around 0.5 m lower than Moat Hill Farm Drive located directly west of the boundary and where an access road is expected to be built. Site levels may therefore require re-grading.

The Party Wall Act may need to be considered for structures associated with neighbouring properties along the site boundaries.

6.2 Foundations

If mine workings are identified as part of the ground investigation, drilling and grouting of the mine workings is expected to be required. Unrecorded mine entries may be located on the site, an allowance should be made to treat such a feature if found.

It is expected that unreinforced strip or trench-fill footings can be used across the majority of the site, taken through any made ground and into undisturbed non-desiccated natural ground. The minimum footing depth is expected to be 900 mm in the natural clay or mudstone, taken from the lowest of existing or finished ground level, and 600 mm to 750 mm in sand over sandstone. The final depth of the footings within the clay or mudstone/shale will be dependent on the volume change potential of the soil which will need to be determined as part of an intrusive investigation.

Where within influencing distance of trees, the footing depth will need to be increased in accordance with the NHBC Standards Chapter 4.2. Precautions against soil heave due to the influence of past or existing trees are likely to be required wherever the footing depth is increased to a depth greater than 1500 mm.

Anecdotal evidence suggests around a third of Clough House is underlain by a cellar. Once this feature has been located and removed, allowance for deepening foundations in this area to found on suitable natural material below should be made. Other cellars associated with former buildings elsewhere on site cannot be discounted.

If foundations span two different ground types, i.e. clay and sand or clay and bedrock, the footings should be thickened and reinforced.

The current Feasibility Sketch Layout, referenced 0208_SK2 dated November 2016, provided by the client, does not show any plots within the footprint of the former railway cutting. The depth of made ground in this area is unknown and therefore should any plots be proposed in this vicinity piles should be allowed for, taken down through the made ground into the underlying bedrock.

6.3 Ground Slabs

Given that gas precautions are expected to be required, precast concrete floors with an underlying minimum 150 mm ventilated void and fully lapped and sealed gas membrane system should be allowed for. The void height will need to be increased if heave precautions are required.

6.4 Superstructure Precautions

Additional superstructure precautions could be necessary if drilling and grouting is found to be required.

6.5 Excavation Problems

Obstructions in the made ground, such as concrete, may be found onsite as a result of previous structures.

Hardstanding is present across a large portion of the western half of the site which will need broken out as part of any investigation. A walled / fenced garden directly east of Clough House is currently inaccessible for large machinery, only pedestrian access is possible.

Manhole covers were observed at surface across the site during the walkover indicating private services to Clough House and the outbuildings exist. Overhead BT cables were observed in the south west of the site.

An electric gate, with passcode entry, provides access to the site off Leeds Road. Any access to the site will need to be arranged and a code obtained.

The stability of trenches may be poor in any made ground and if shallow perched groundwater is encountered. Temporary support will be required in accordance with current Health & Safety

Regulations wherever access is required to trenches deeper than 1.2 m or less where there is risk of collapse.

6.6 Obstructions

A remnant rectangular concrete base was observed to the north of Clough House during the site walkover, its purpose is unknown and further similar features or slabs cannot be discounted.

A well (east) and a pump (west) were mapped in 1894 and between 1894 to 1908 respectively. If either of these features is encountered during the investigation or future works they will need to be confirmed to have been appropriately backfilled and possibly capped.

6.7 Roads

A CBR value of at least 2% is expected to be appropriate for road design. It is recommended that CBR tests are undertaken along any proposed roads prior to construction so that accurate CBR values can be obtained. The ground should be assumed to be frost susceptible and a minimum construction thickness of 450 mm will therefore apply.

6.8 Surface Water Drainage

Soakaways may be viable within the expected sandstone band across the centre of the site. However, clay soils are expected to the north and south and may be present at shallow depth overlying the sandstone bedrock. Soakaways are therefore not expected to be viable across the majority of the site.

7.0 RECOMMENDATIONS FOR FURTHER WORK

Before more definite information regarding the properties of the ground and any contamination present can be given, an intrusive ground investigation will be required. Investigation by mechanically dug trial pits would be the preferred method of investigating the soils on site, as this allows a larger volume of soil to be viewed. Some of these will need to target the footprints of the former structures, tanks and the infilled railway cutting.

Investigation of the coal seams and any workings beneath the site is proposed by rotary boreholes.

If deep made ground is found, cable percussion boreholes will be required to investigate the depth of made ground and collect strength data for pile design.

A gas monitoring programme will be required to determine the current gassing regime of the site.

In areas with granular soils, and where deep made ground is not encountered, infiltration testing could be undertaken to establish the viability of soakaway drainage.

The potential pollutant linkages presented in Section 5.3 will need to be investigated by means of soil analysis. The chemical testing suite should be chosen to cover the range of potential contaminants indicated. If any clay soils are encountered geotechnical testing should be carried out to determine their volume change potential.

APPENDIX

Site Photographs

Envirocheck

Consultants Coal Mining Report



Looking north west up to Clough House from the site entrance

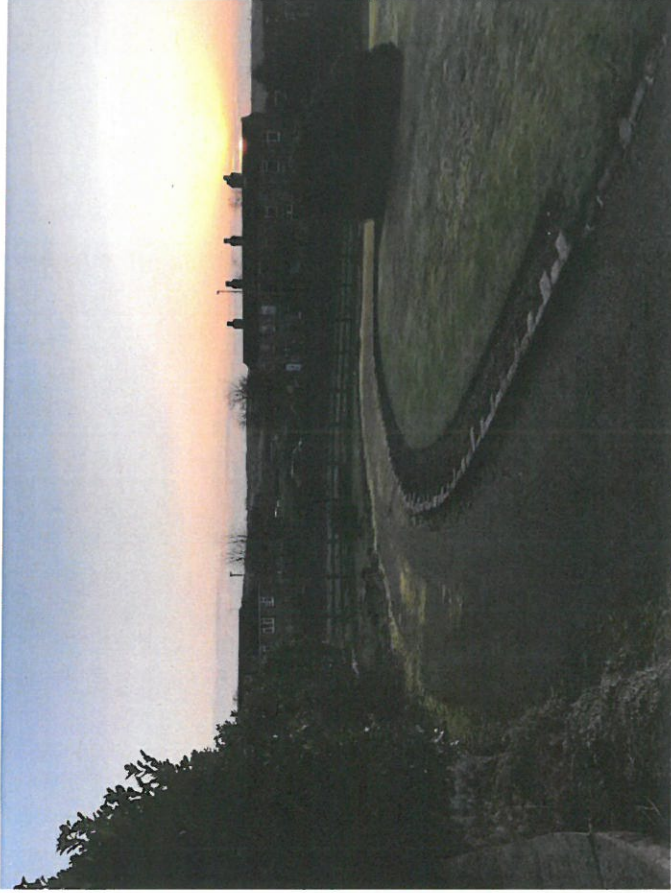

Looking towards the south eastern corner of the site from the front of Clough House

Prepared	NG	Checked	CAT	Date	09.12.19	Photograph No	1 & 2
----------	----	---------	-----	------	----------	---------------	-------

EOP
Eastwood & Partners
 CONSULTING ENGINEERS

St Andrew's House
 23 Kingfield Road
 Sheffield S11 9AS
 Tel: (0114) 2554554 Fax: (0114) 2554330

CLOUGH HOUSE, LEEDS ROAD, BIRSTALL

ROSIE CARR

SITE PHOTOGRAPHS



View of the south eastern corner of the site looking north



Pedestrian access to the enclosed garden located to the east of Clough House

Prepared	NG	Checked	CAT	Date	09.12.19	Photograph No	3 & 4
----------	----	---------	-----	------	----------	---------------	-------

E+P
Eastwood & Partners
 CONSULTING ENGINEERS

St Andrew's House
 23 Kingfield Road
 Sheffield S11 9AS

Tel: (0114) 2554554 Fax: (0114) 2554330

CLOUGH HOUSE, LEEDS ROAD, BIRSTALL

ROSIE CARR

SITE PHOTOGRAPHS



Within the walled garden looking west towards Clough House



Looking north east towards the outbuildings directly north of Clough House

Prepared	NG	Checked	CAT	Date	09.12.19	Photograph No	5 & 6
----------	----	---------	-----	------	----------	---------------	-------

EOP
Eastwood & Partners
 CONSULTING ENGINEERS

St Andrew's House
 23 Kingfield Road
 Sheffield S11 9AS
 Tel: (0114) 2554554 Fax: (0114) 2554330

CLOUGH HOUSE, LEEDS ROAD, BIRSTALL

ROSIE CARR

SITE PHOTOGRAPHS



View looking west between outbuildings towards the entrance to Moat Hill Farm Drive beyond the site boundary

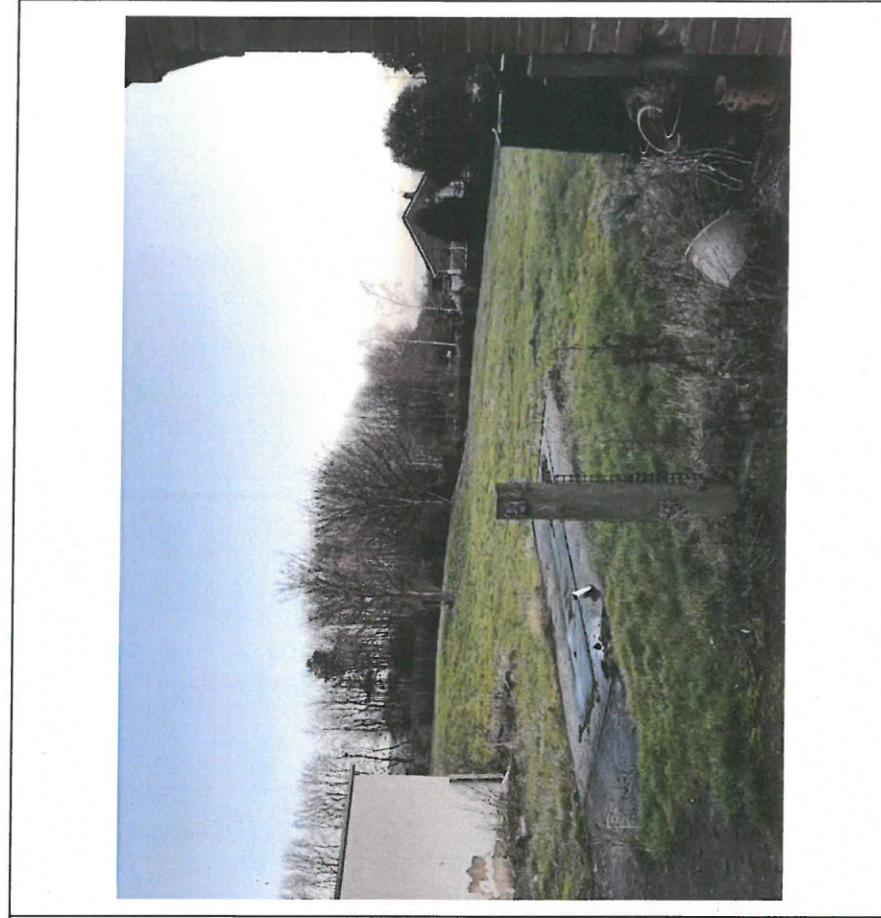

View looking east across the grassy area from the outbuildings

Prepared	NG	Checked	CAT	Date	09.12.19	Photograph No	7 & 8
----------	----	---------	-----	------	----------	---------------	-------

Eastwood & Partners
CONSULTING ENGINEERS
St Andrew's House
23 Kingfield Road
Sheffield S11 9AS
Tel: (0114) 2554554 Fax: (0114) 2554330

CLOUGH HOUSE, LEEDS ROAD, BIRSTALL
ROSIE CARR
SITE PHOTOGRAPHS



Looking south east from the northern site boundary



Remnant rectangular concrete base located between the outbuildings

Prepared	NG	Checked	CAT	Date	09.12.19	Photograph No	9 & 10
----------	----	---------	-----	------	----------	---------------	--------

EOP
Eastwood & Partners
 CONSULTING ENGINEERS

St Andrew's House
 23 Kingfield Road
 Sheffield S11 9AS

Tel: (0114) 2554554 Fax: (0114) 2554330

CLOUGH HOUSE, LEEDS ROAD, BIRSTALL

ROSIE CARR

SITE PHOTOGRAPHS

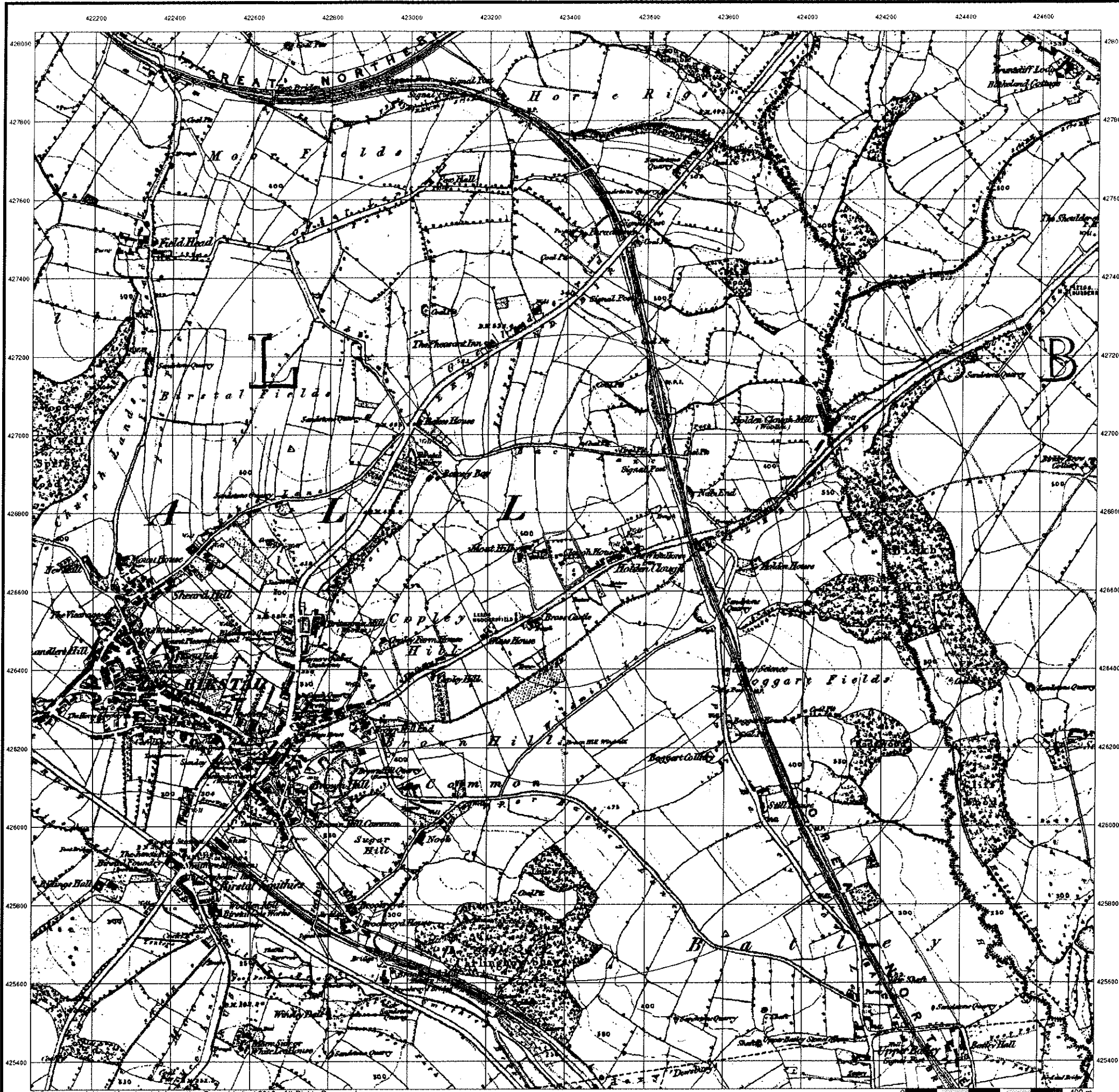

© Crown copyright and Landmark Information Group Limited 2019. All Rights Reserved

Envirocheck

LANDMARK INFORMATION GROUP

Yorkshire
Published 1854
Source map scale - 1:10,560

The historical maps shown were reproduced from maps predominantly held at the scale adopted for England, Wales and Scotland in the 1840's. In 1854 the 1:2,500 scale was adopted for mapping urban areas; these maps were used to update the 1:10,560 maps. The published date given therefore is often some years later than the surveyed date. Before 1938, all OS maps were based on the Cassini Projection, with independent surveys of a single county or group of counties, giving rise to significant inaccuracies in outlying areas. In the late 1940's, a Provisional Edition was produced, which updated the 1:10,560 mapping from a number of sources. The maps appear unfinished - with all military camps and other strategic sites removed. These maps were initially overprinted with the National Grid. In 1970, the first 1:10,000 maps were produced using the Transverse Mercator Projection. The revision process continued until recently, with new editions appearing every 10 years or so for urban areas.

Map Name(s) and Date(s)

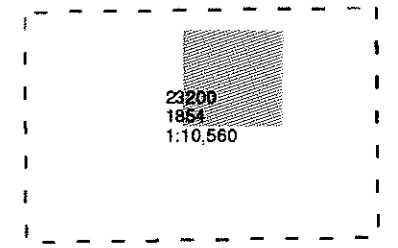

Historical Map - Slice A

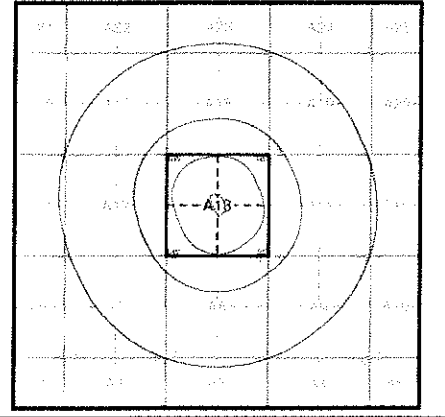

Order Details

Order Number: 226382729_1_1
 Customer Ref: 44688
 National Grid Reference: 423390, 426680
 Slice: A
 Site Area (Ha): 0.93
 Search Buffer (m): 1000

Site Details

Site at 423390, 426690

Landmark
 LANDMARK INFORMATION GROUP

Tel: 0844 844 9952
 Fax: 0844 844 9951
 Web: www.envirocheck.co.uk

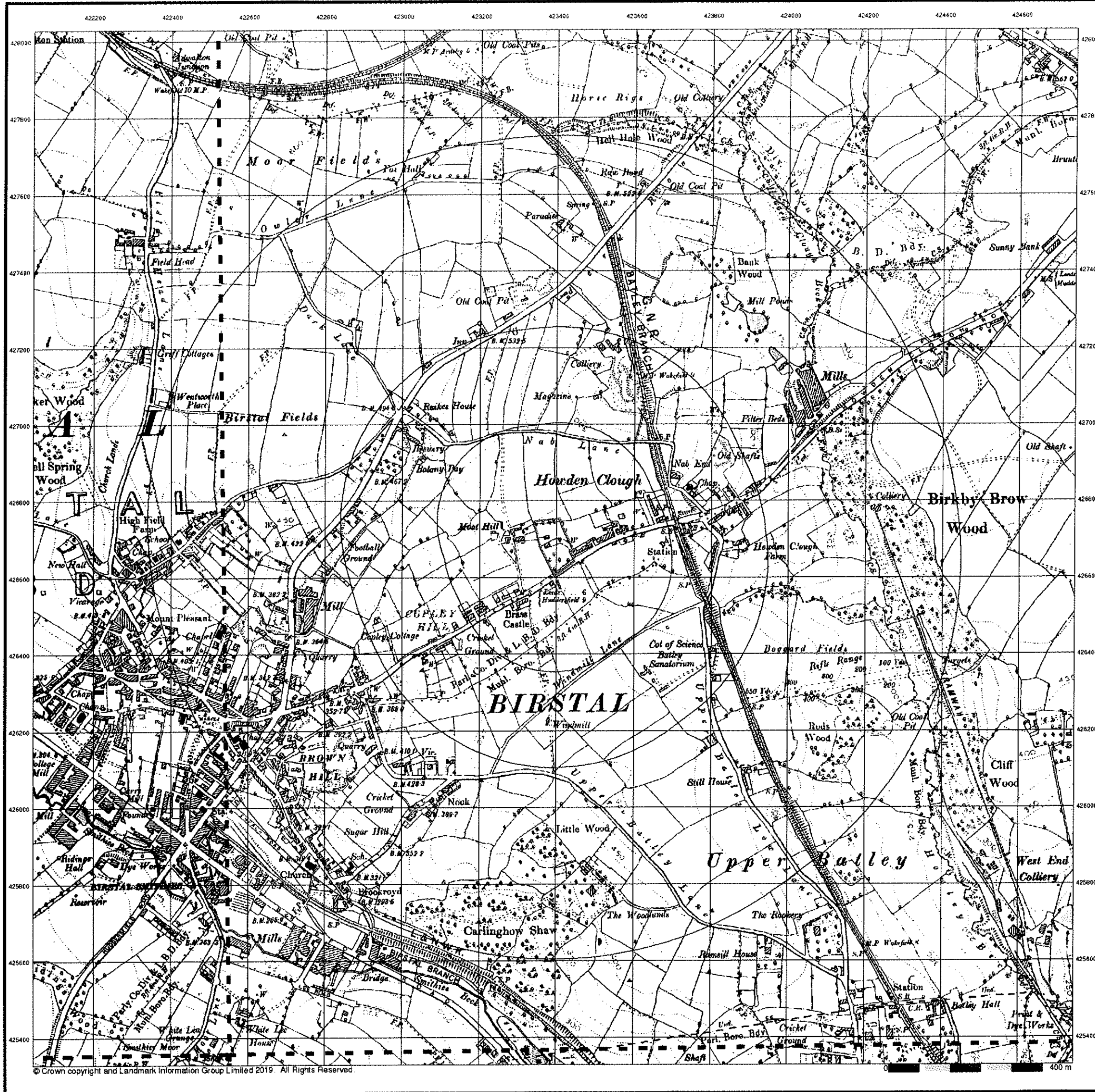

Envirocheck

LANDMARK INFORMATION GROUP

Yorkshire
Published 1894 - 1895
Source map scale - 1:10,560

The historical maps shown were reproduced from maps predominantly held at the scale adopted for England, Wales and Scotland in the 1840's. In 1854 the 1:2,500 scale was adopted for mapping urban areas; these maps were used to update the 1:10,560 maps. The published date given therefore is often some years later than the surveyed date. Before 1938, all OS maps were based on the Cassini Projection, with independent surveys of a single county or group of counties, giving rise to significant inaccuracies in outlying areas. In the late 1940's, a Provisional Edition was produced, which updated the 1:10,560 mapping from a number of sources. The maps appear unfinished - with all military camps and other strategic sites removed. These maps were initially overprinted with the National Grid. In 1970, the first 1:10,000 maps were produced using the Transverse Mercator Projection. The revision process continued until recently, with new editions appearing every 10 years or so for urban areas.

Map Name(s) and Date(s)

232NW 1894 1:10,560	232NE 1894 1:10,560
232SW 1894 1:10,560	232SE 1895 1:10,560

Historical Map - Slice A

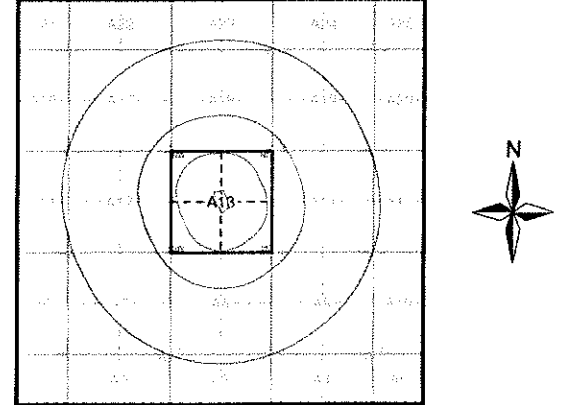

Order Details

Order Number: 226382729_1_1
 Customer Ref: 44688
 National Grid Reference: 423390, 426680
 Slice: A
 Site Area (Ha): 0.93
 Search Buffer (m): 1000

Site Details

Site at 423390, 426690

Landmark
 LANDMARK INFORMATION GROUP

Tel: 0844 844 9952
 Fax: 0844 844 9951
 Web: www.envirocheck.co.uk

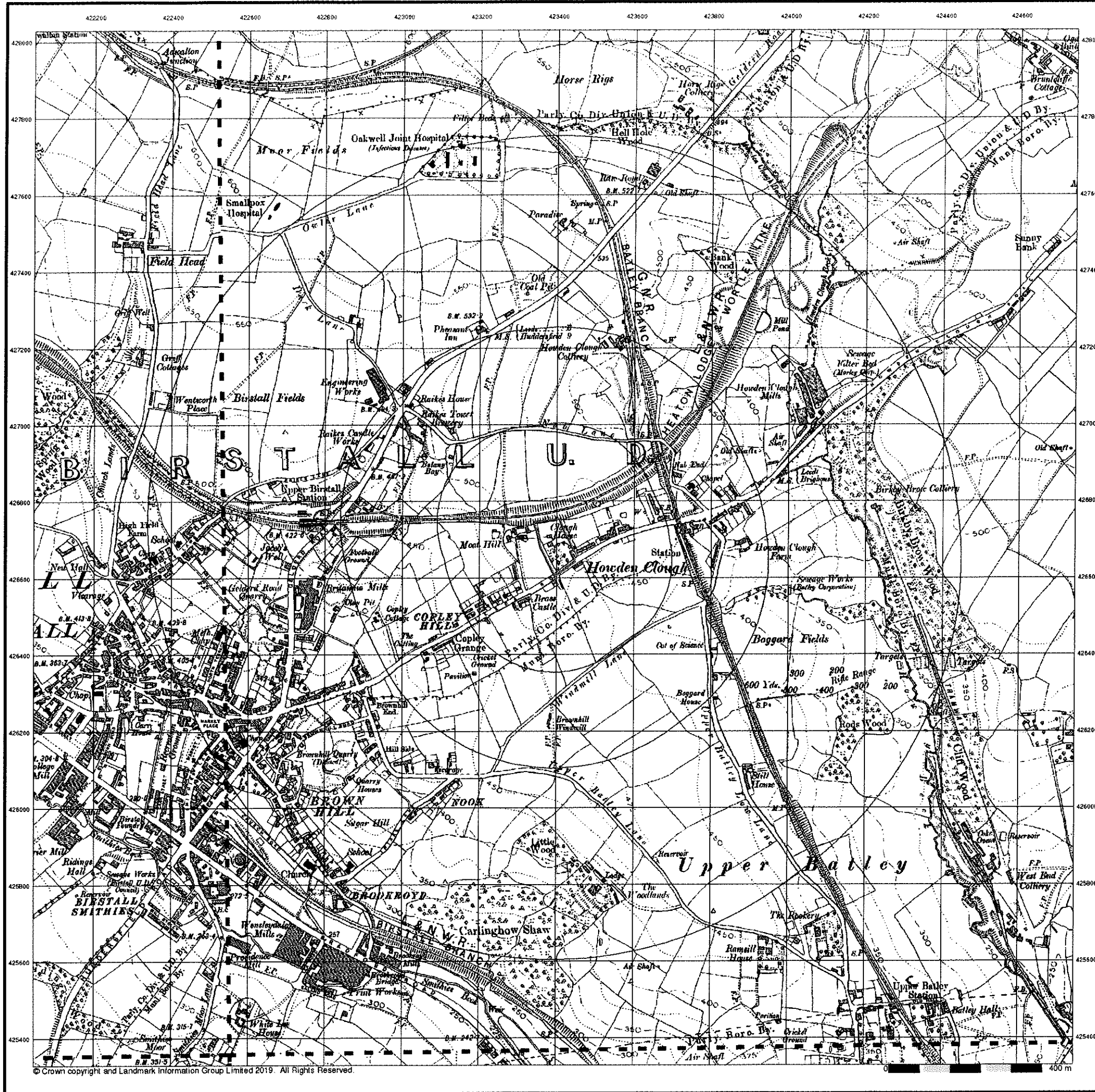

Envirocheck

LANDMARK INFORMATION GROUP

Yorkshire
Published 1908
Source map scale - 1:10,560

The historical maps shown were reproduced from maps predominantly held at the scale adopted for England, Wales and Scotland in the 1840's. In 1854 the 1:2,500 scale was adopted for mapping urban areas; these maps were used to update the 1:10,560 maps. The published date given therefore is often some years later than the surveyed date. Before 1938, all OS maps were based on the Cassini Projection, with independent surveys of a single county or group of counties, giving rise to significant inaccuracies in outlying areas. In the late 1940's, a Provisional Edition was produced, which updated the 1:10,560 mapping from a number of sources. The maps appear unfinished - with all military camps and other strategic sites removed. These maps were initially overprinted with the National Grid. In 1970, the first 1:10,000 maps were produced using the Transverse Mercator Projection. The revision process continued until recently, with new editions appearing every 10 years or so for urban areas.

Map Name(s) and Date(s)

232NW 1908 1:10,560	232NE 1908 1:10,560
232SW 1908 1:10,560	232SE 1908 1:10,560

Historical Map - Slice A

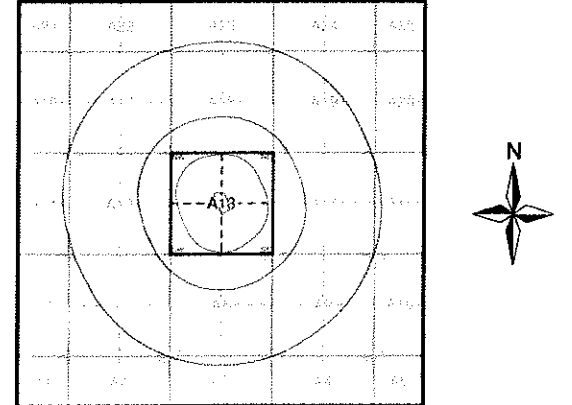

Order Details

Order Number: 226382729_1_1
 Customer Ref: 44688
 National Grid Reference: 423390, 426680
 Slice: A
 Site Area (Ha): 0.93
 Search Buffer (m): 1000

Site Details

Site at 423390, 426690

Landmark
 LANDMARK INFORMATION GROUP

Tel: 0844 844 9952
 Fax: 0844 844 9951
 Web: www.envirocheck.co.uk

Envirocheck

LANDMARK INFORMATION GROUP

Yorkshire

Published 1931 - 1932

Source map scale - 1:10,560

The historical maps shown were reproduced from maps predominantly held at the scale adopted for England, Wales and Scotland in the 1840's. In 1854 the 1:2,500 scale was adopted for mapping urban areas; these maps were used to update the 1:10,560 maps. The published date given therefore is often some years later than the surveyed date. Before 1938, all OS maps were based on the Cassini Projection, with independent surveys of a single county or group of counties, giving rise to significant inaccuracies in outlying areas. In the late 1940's, a Provisional Edition was produced, which updated the 1:10,560 mapping from a number of sources. The maps appear unfinished - with all military camps and other strategic sites removed. These maps were initially overprinted with the National Grid. In 1970, the first 1:10,000 maps were produced using the Transverse Mercator Projection. The revision process continued until recently, with new editions appearing every 10 years or so for urban areas.

Map Name(s) and Date(s)

232NW 1932 1:10,560	232NE 1932 1:10,560
232SW 1931 1:10,560	232SE 1931 1:10,560

Historical Map - Slice A

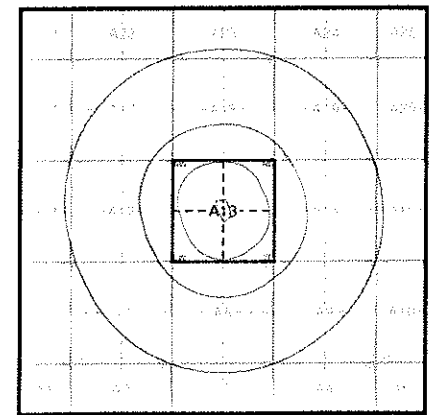

Order Details

Order Number: 226382729_1_1
 Customer Ref: 44688
 National Grid Reference: 423390, 426680
 Slice: A
 Site Area (Ha): 0.93
 Search Buffer (m): 1000

Site Details

Site at 423390, 426690

Landmark
 LANDMARK INFORMATION GROUP

Tel: 0844 844 9952
 Fax: 0844 844 9951
 Web: www.envirocheck.co.uk

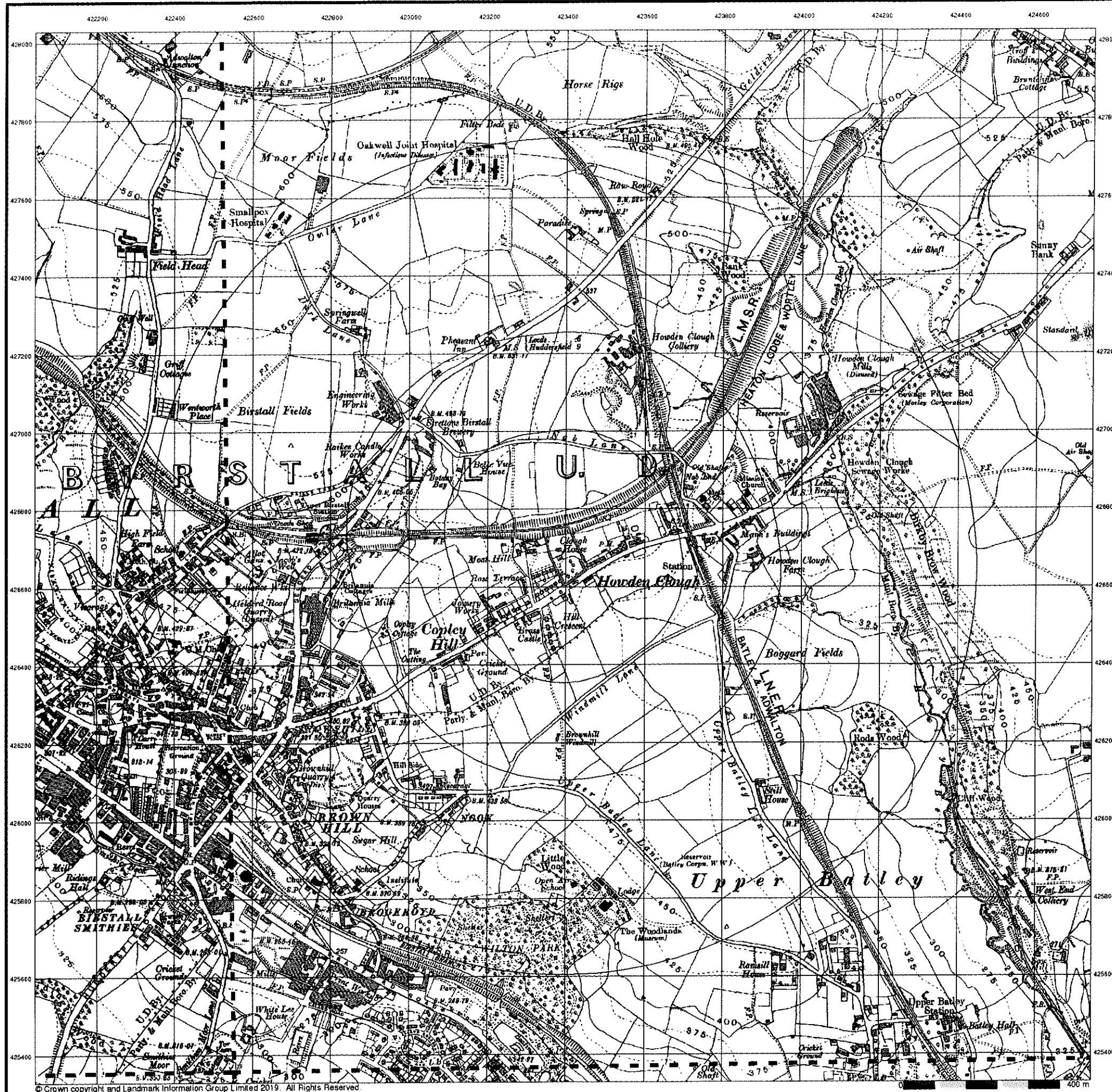

© Crown copyright and Landmark Information Group Limited 2019. All Rights Reserved.

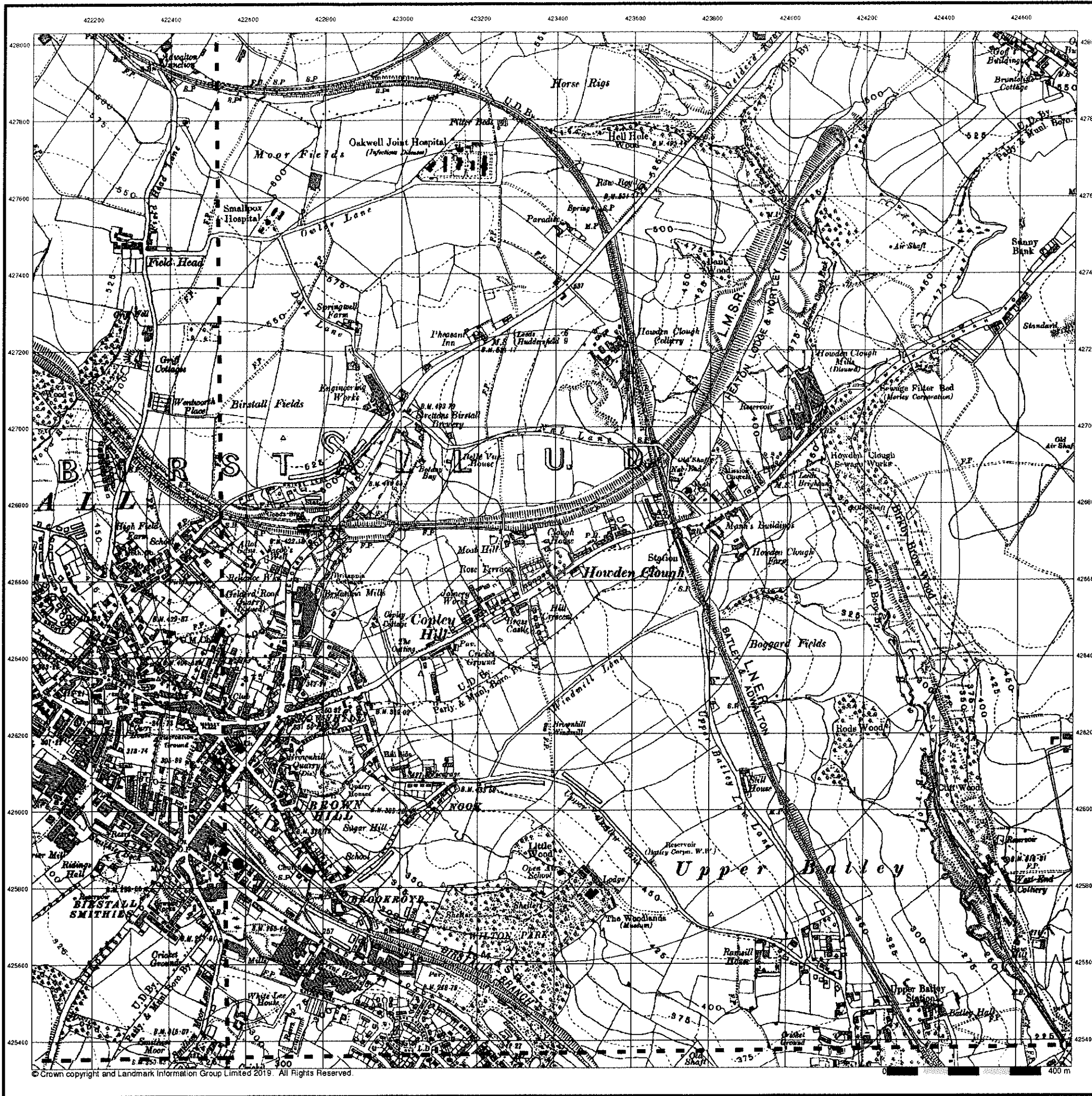

Envirocheck

LANDMARK INFORMATION GROUP

Yorkshire
Published 1938
Source map scale - 1:10,560

The historical maps shown were reproduced from maps predominantly held at the scale adopted for England, Wales and Scotland in the 1840's. In 1854 the 1:2,500 scale was adopted for mapping urban areas; these maps were used to update the 1:10,560 maps. The published date given therefore is often some years later than the surveyed date. Before 1938, all OS maps were based on the Cassini Projection, with independent surveys of a single county or group of counties, giving rise to significant inaccuracies in outlying areas. In the late 1940's, a Provisional Edition was produced, which updated the 1:10,560 mapping from a number of sources. The maps appear unfinished - with all military camps and other strategic sites removed. These maps were initially overprinted with the National Grid. In 1970, the first 1:10,000 maps were produced using the Transverse Mercator Projection. The revision process continued until recently, with new editions appearing every 10 years or so for urban areas.

Map Name(s) and Date(s)

232NW 1938 1:10,560	232NE 1938 1:10,560
232SW 1938 1:10,560	232SE 1938 1:10,560

Historical Map - Slice A

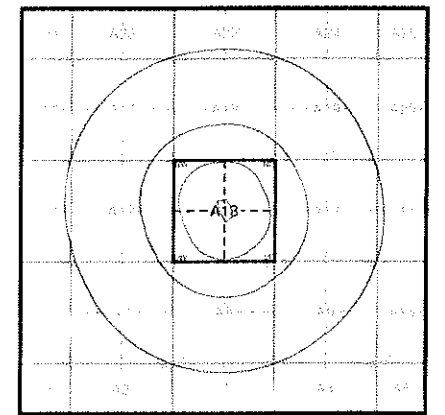

Order Details

Order Number: 226382729_1_1
 Customer Ref: 44688
 National Grid Reference: 423390, 426680
 Slice: A
 Site Area (Ha): 0.93
 Search Buffer (m): 1000

Site Details

Site at 423390, 426690

Landmark
 LANDMARK INFORMATION GROUP

Tel: 0844 844 9952
 Fax: 0844 844 9951
 Web: www.envirocheck.co.uk

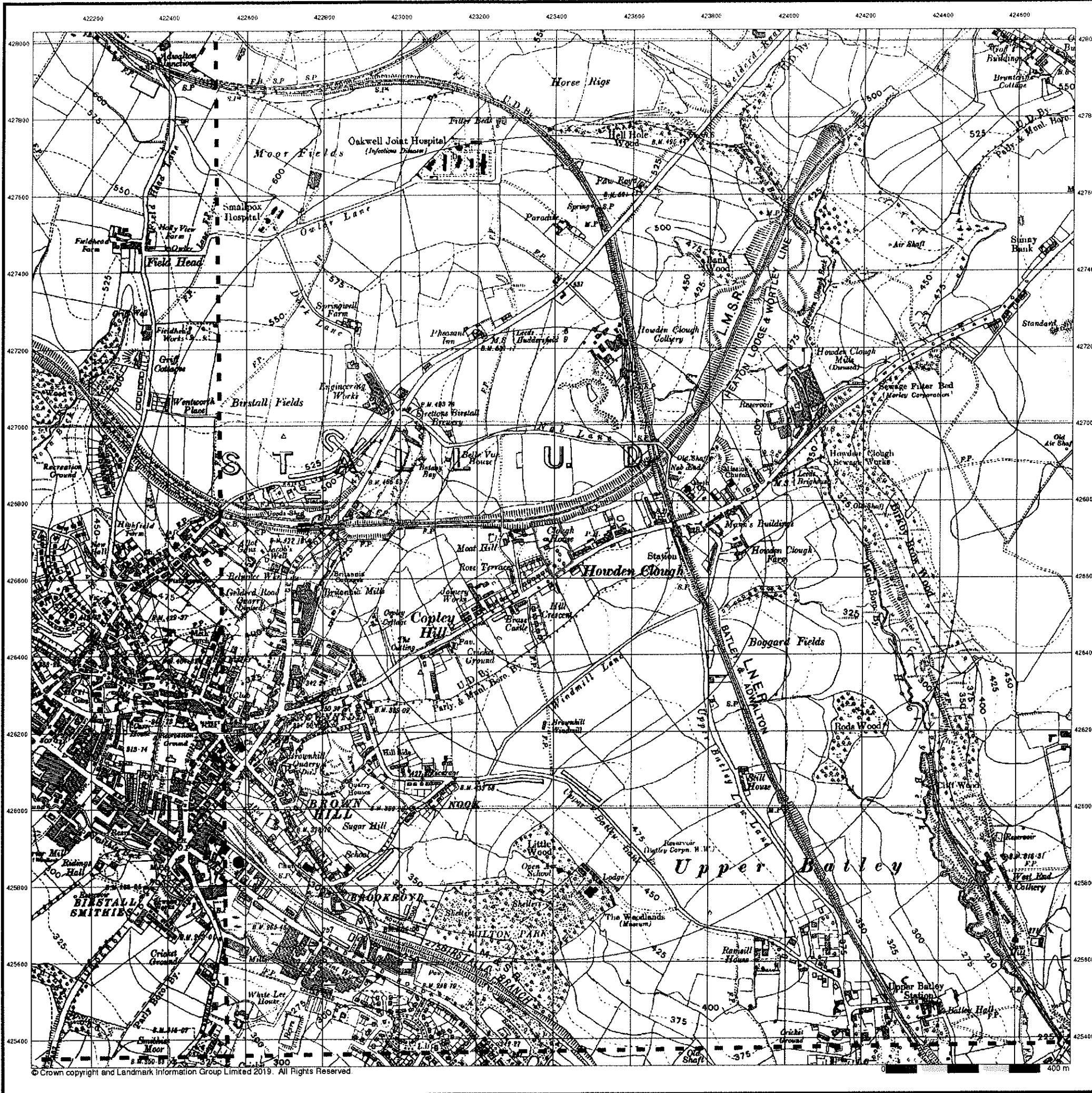

Envirocheck

LANDMARK INFORMATION GROUP

Yorkshire

Published 1938 - 1948

Source map scale - 1:10,560

The historical maps shown were reproduced from maps predominantly held at the scale adopted for England, Wales and Scotland in the 1840's. In 1854 the 1:2,500 scale was adopted for mapping urban areas; these maps were used to update the 1:10,560 maps. The published date given therefore is often some years later than the surveyed date. Before 1938, all OS maps were based on the Cassini Projection, with independent surveys of a single county or group of counties, giving rise to significant inaccuracies in outlying areas. In the late 1940's, a Provisional Edition was produced, which updated the 1:10,560 mapping from a number of sources. The maps appear unfinished - with all military camps and other strategic sites removed. These maps were initially overprinted with the National Grid. In 1970, the first 1:10,000 maps were produced using the Transverse Mercator Projection. The revision process continued until recently, with new editions appearing every 10 years or so for urban areas.

Map Name(s) and Date(s)

232NW 1948 1:10,560	232NE 1938 1:10,560
232SW 1938 1:10,560	232SE 1948 1:10,560

Historical Map - Slice A

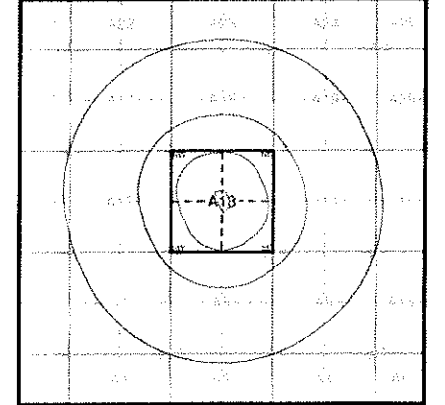

Order Details

Order Number: 226382729_1_1
 Customer Ref: 44688
 National Grid Reference: 423390, 426680
 Slice: A
 Site Area (Ha): 0.93
 Search Buffer (m): 1000

Site Details

Site at 423390, 426690

Landmark
 INFORMATION GROUP

Tel: 0844 844 9952
 Fax: 0844 844 9951
 Web: www.envirocheck.co.uk

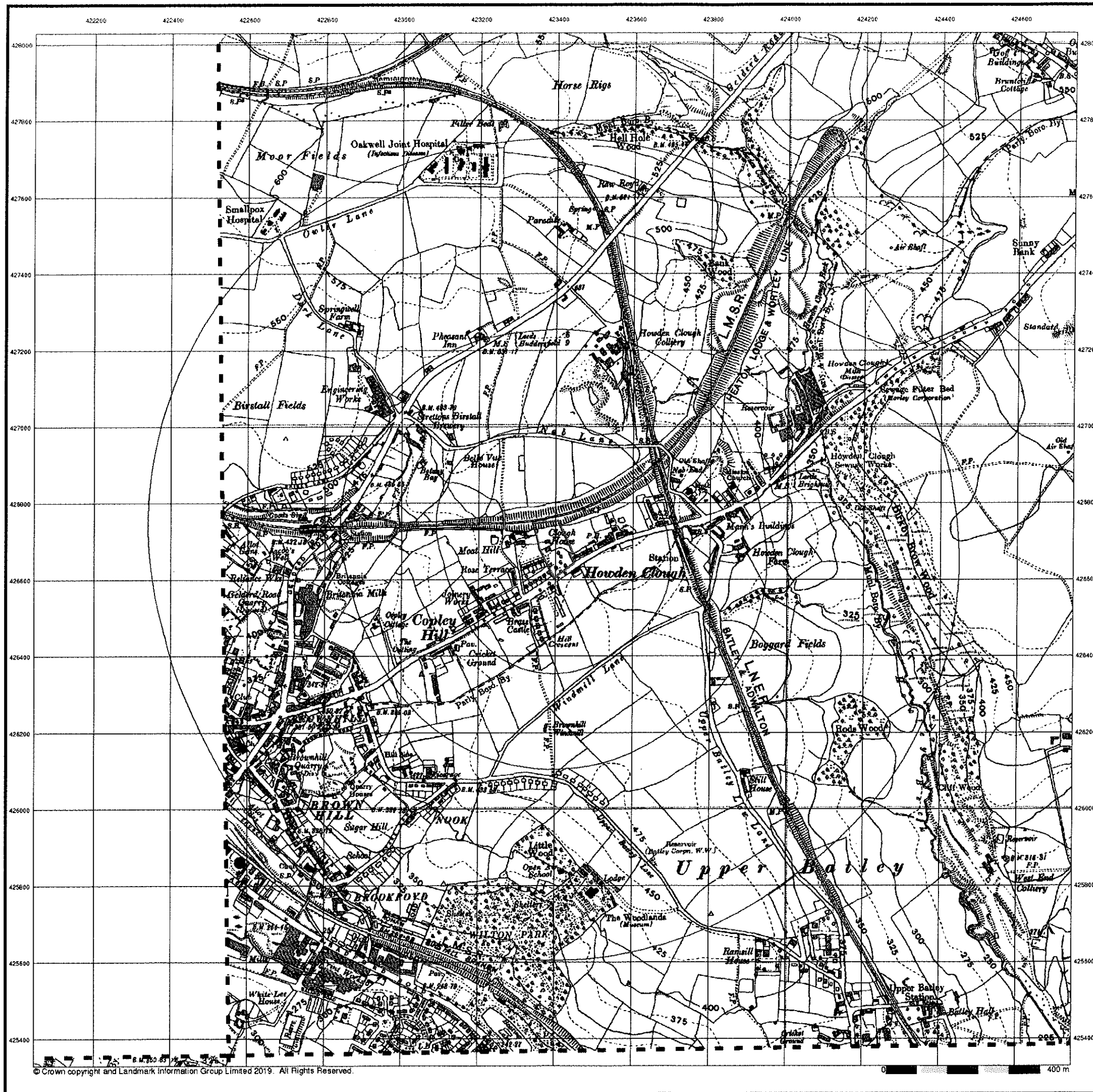

Envirocheck

LANDMARK INFORMATION GROUP

Yorkshire

Published 1948

Source map scale - 1:10,560

The historical maps shown were reproduced from maps predominantly held at the scale adopted for England, Wales and Scotland in the 1840's. In 1854 the 1:2,500 scale was adopted for mapping urban areas; these maps were used to update the 1:10,560 maps. The published date given therefore is often some years later than the surveyed date. Before 1938, all OS maps were based on the Cassini Projection, with independent surveys of a single county or group of counties, giving rise to significant inaccuracies in outlying areas. In the late 1940's, a Provisional Edition was produced, which updated the 1:10,560 mapping from a number of sources. The maps appear unfinished - with all military camps and other strategic sites removed. These maps were initially overprinted with the National Grid. In 1970, the first 1:10,000 maps were produced using the Transverse Mercator Projection. The revision process continued until recently, with new editions appearing every 10 years or so for urban areas.

Map Name(s) and Date(s)

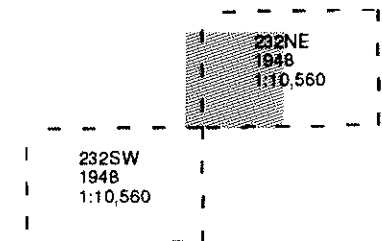

Historical Map - Slice A

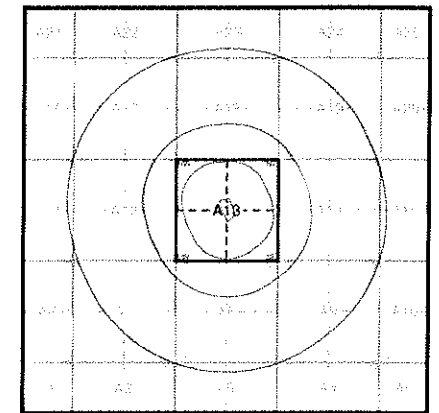

Order Details

Order Number: 226382729_1_1
 Customer Ref: 44688
 National Grid Reference: 423390, 426680
 Slice: A
 Site Area (Ha): 0.93
 Search Buffer (m): 1000

Site Details

Site at 423390, 426690

Landmark
 LANDMARK INFORMATION GROUP

Tel: 0844 844 9952
 Fax: 0844 844 9951
 Web: www.envirocheck.co.uk

Ordnance Survey Plan

Published 1955

Source map scale - 1:10,000

The historical maps shown were reproduced from maps predominantly held at the scale adopted for England, Wales and Scotland in the 1840's. In 1854 the 1:2,500 scale was adopted for mapping urban areas; these maps were used to update the 1:10,560 maps. The published date given therefore is often some years later than the surveyed date. Before 1938, all OS maps were based on the Cassini Projection, with independent surveys of a single county or group of counties, giving rise to significant inaccuracies in outlying areas. In the late 1940's, a Provisional Edition was produced, which updated the 1:10,560 mapping from a number of sources. The maps appear unfinished - with all military camps and other strategic sites removed. These maps were initially overprinted with the National Grid. In 1970, the first 1:10,000 maps were produced using the Transverse Mercator Projection. The revision process continued until recently, with new editions appearing every 10 years or so for urban areas.

Map Name(s) and Date(s)

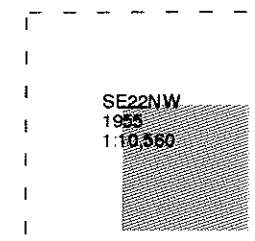

Historical Map - Slice A

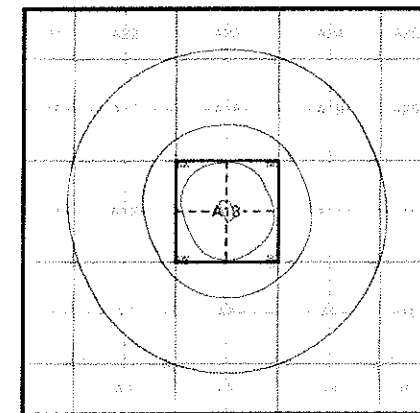

Order Details

Order Number: 226382729_1_1
Customer Ref: 44688
National Grid Reference: 423390, 426680
Slice: A
Site Area (Ha): 0.93
Search Buffer (m): 1000

Site Details

Site at 423390, 426690

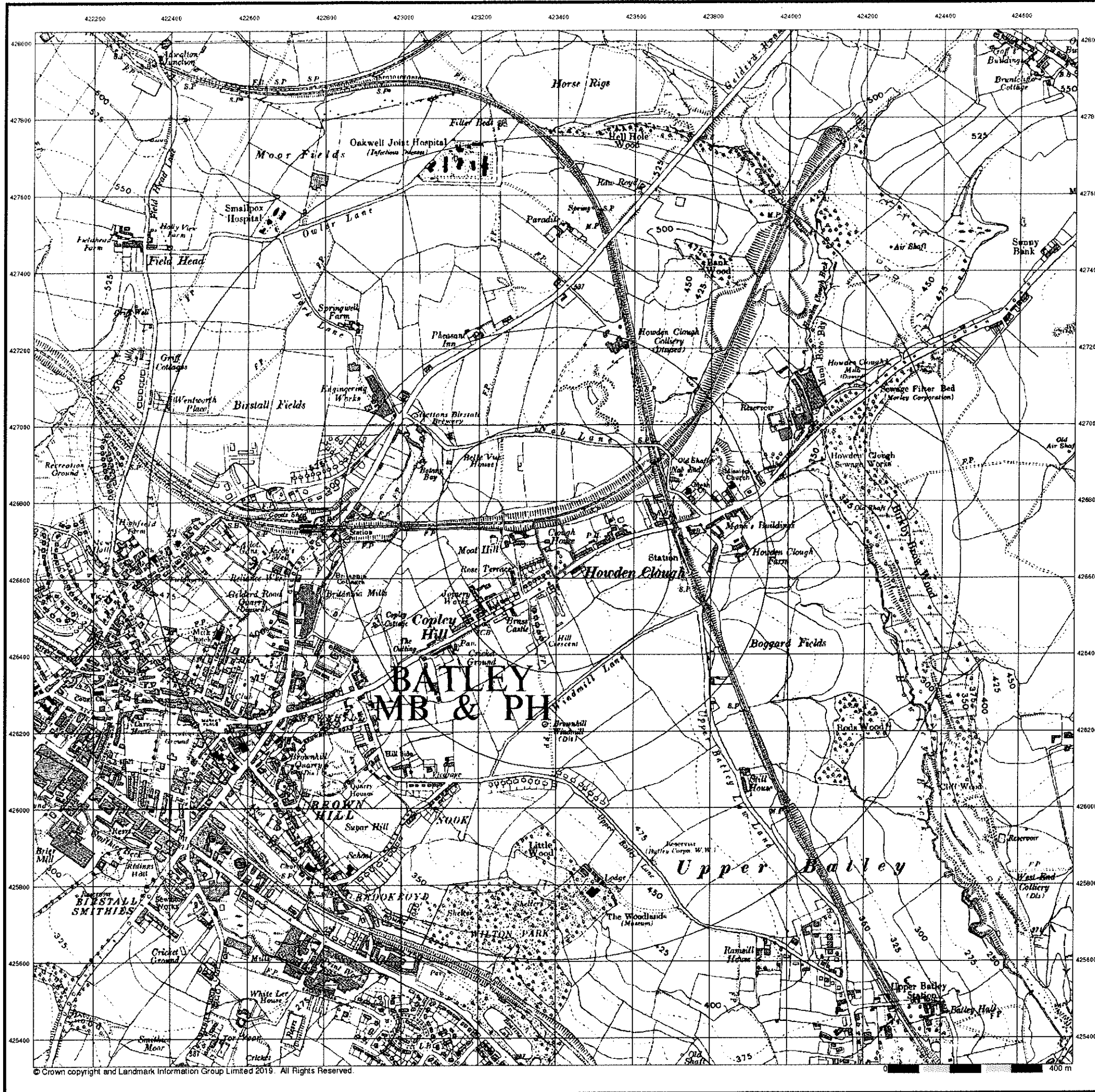

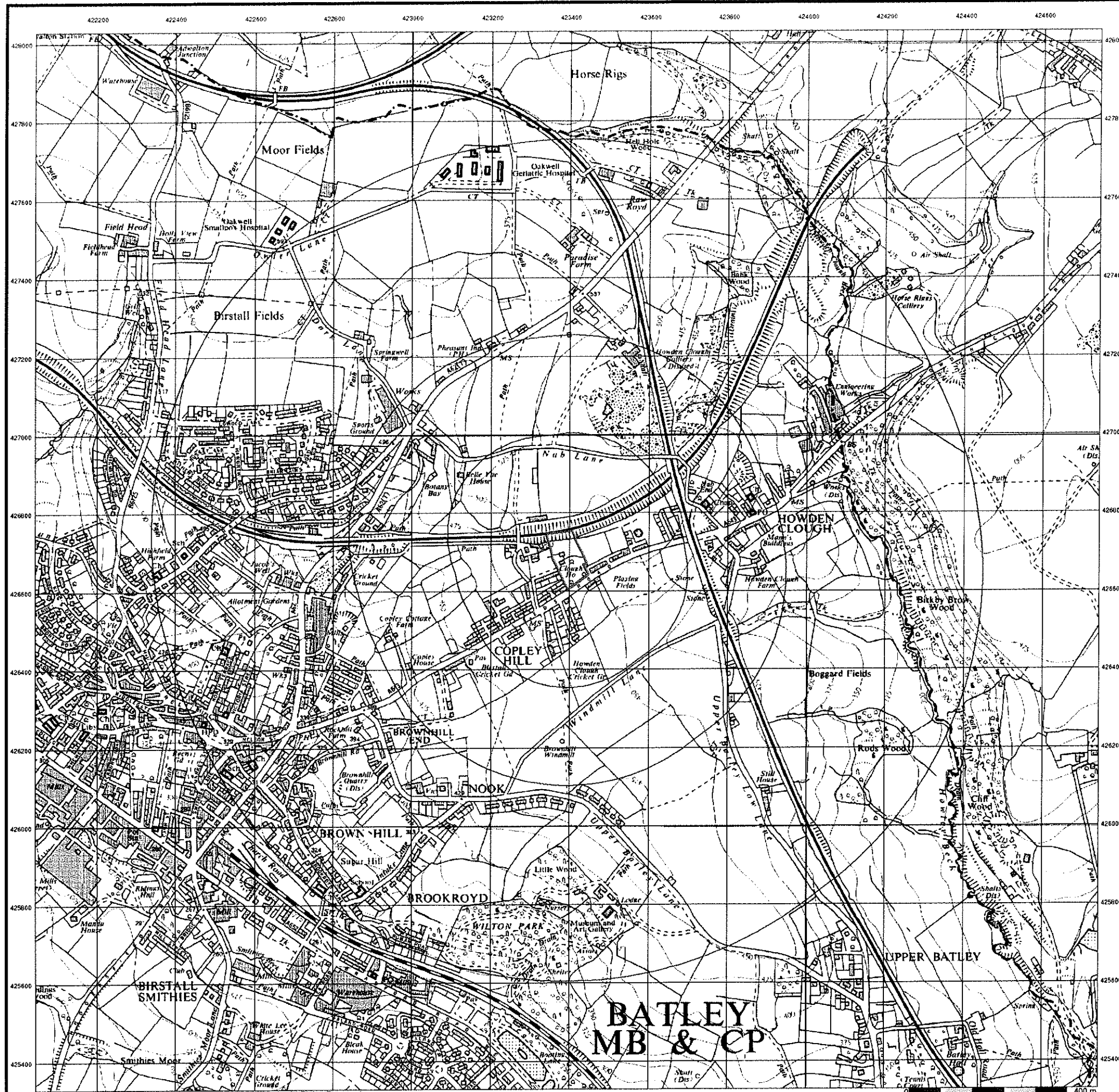

Envirocheck

LANDMARK INFORMATION GROUP

Ordnance Survey Plan
Published 1966
Source map scale - 1:10,000

The historical maps shown were reproduced from maps predominantly held at the scale adopted for England, Wales and Scotland in the 1840's. In 1854 the 1:2,500 scale was adopted for mapping urban areas; these maps were used to update the 1:10,560 maps. The published date given therefore is often some years later than the surveyed date. Before 1938, all OS maps were based on the Cassini Projection, with independent surveys of a single county or group of counties, giving rise to significant inaccuracies in outlying areas. In the late 1940's, a Provisional Edition was produced, which updated the 1:10,560 mapping from a number of sources. The maps appear unfinished - with all military camps and other strategic sites removed. These maps were initially overprinted with the National Grid. In 1970, the first 1:10,000 maps were produced using the Transverse Mercator Projection. The revision process continued until recently, with new editions appearing every 10 years or so for urban areas.

Map Name(s) and Date(s)

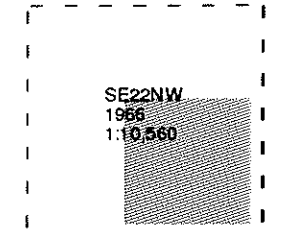

Historical Map - Slice A

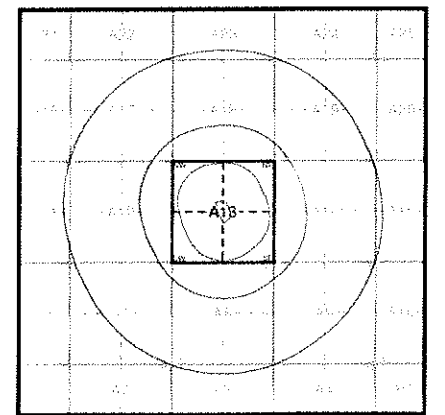

Order Details

Order Number: 226382729_1_1
 Customer Ref: 44688
 National Grid Reference: 423390, 426680
 Slice: A
 Site Area (Ha): 0.93
 Search Buffer (m): 1000

Site Details

Site at 423390, 426690

Landmark
 LANDMARK INFORMATION GROUP

Tel: 0844 844 9952
 Fax: 0844 844 9951
 Web: www.envirocheck.co.uk

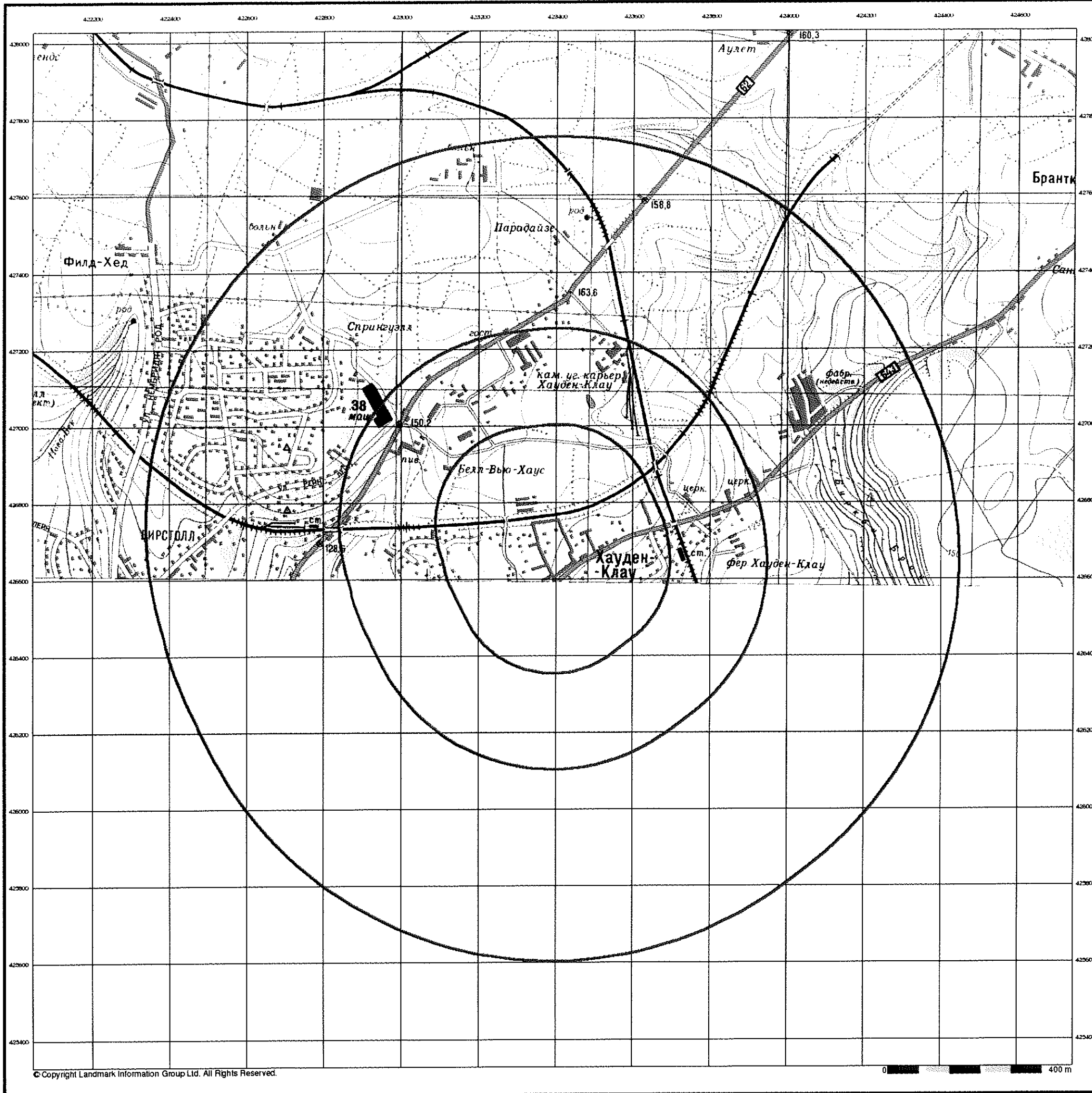

Leeds
Published 1972
Source map scale - 1:10,000

These maps were produced by the Russian military during the Cold War between 1950 and 1997, and cover 103 towns and cities throughout the U.K. The maps are produced at 1:25,000, 1:10,000 and 1:5,000 scale, and show detailed land use, with colour-coded areas for development, green areas, and non-developed areas. Buildings are coloured black and important building uses (such as hospitals, post offices, factories etc.) are numbered, with a numbered key describing their use. They were produced by the Russians for the benefit of navigation, as well as strategic military sites and transport hubs, for use if they were to have invaded the U.K. The detailed information provided indicates that the areas were surveyed using land-based personnel, on the ground, in the cities that are mapped.

Map Name(s) and Date(s)

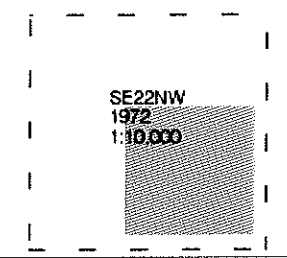

Russian Map - Slice A

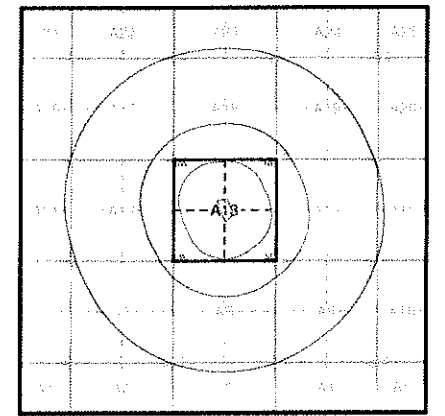

Order Details

Order Number: 226382729_1_1
 Customer Ref: 44688
 National Grid Reference: 423390, 426680
 Slice: A
 Site Area (Ha): 0.93
 Search Buffer (m): 1000

Site Details

Site at 423390, 426690

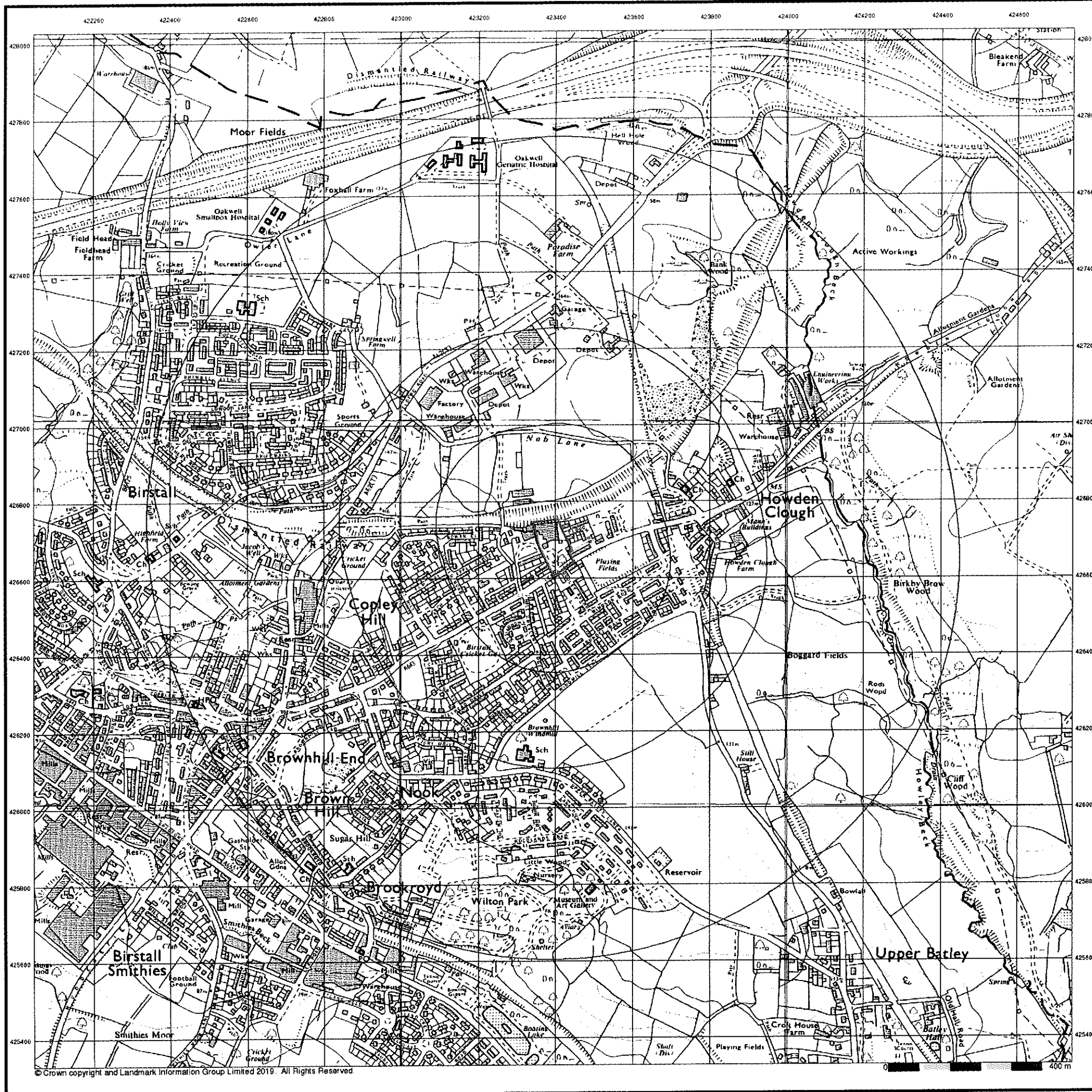

Envirocheck

LANDMARK INFORMATION GROUP

Ordnance Survey Plan

Published 1976

Source map scale - 1:10,000

The historical maps shown were reproduced from maps predominantly held at the scale adopted for England, Wales and Scotland in the 1840's. In 1854 the 1:2,500 scale was adopted for mapping urban areas; these maps were used to update the 1:10,560 maps. The published date given therefore is often some years later than the surveyed date. Before 1938, all OS maps were based on the Cassini Projection, with independent surveys of a single county or group of counties, giving rise to significant inaccuracies in outlying areas. In the late 1940's, a Provisional Edition was produced, which updated the 1:10,560 mapping from a number of sources. The maps appear unfinished - with all military camps and other strategic sites removed. These maps were initially overprinted with the National Grid. In 1970, the first 1:10,000 maps were produced using the Transverse Mercator Projection. The revision process continued until recently, with new editions appearing every 10 years or so for urban areas.

Map Name(s) and Date(s)

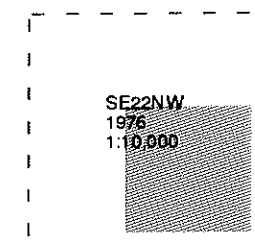

Historical Map - Slice A

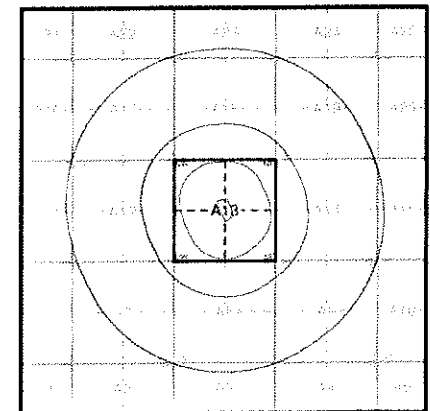

Order Details

Order Number: 226382729_1_1
 Customer Ref: 44688
 National Grid Reference: 423390, 426680
 Slice: A
 Site Area (Ha): 0.93
 Search Buffer (m): 1000

Site Details

Site at 423390, 426690

Landmark
 LANDMARK INFORMATION GROUP

Tel: 0844 844 9952
 Fax: 0844 844 9951
 Web: www.envirocheck.co.uk

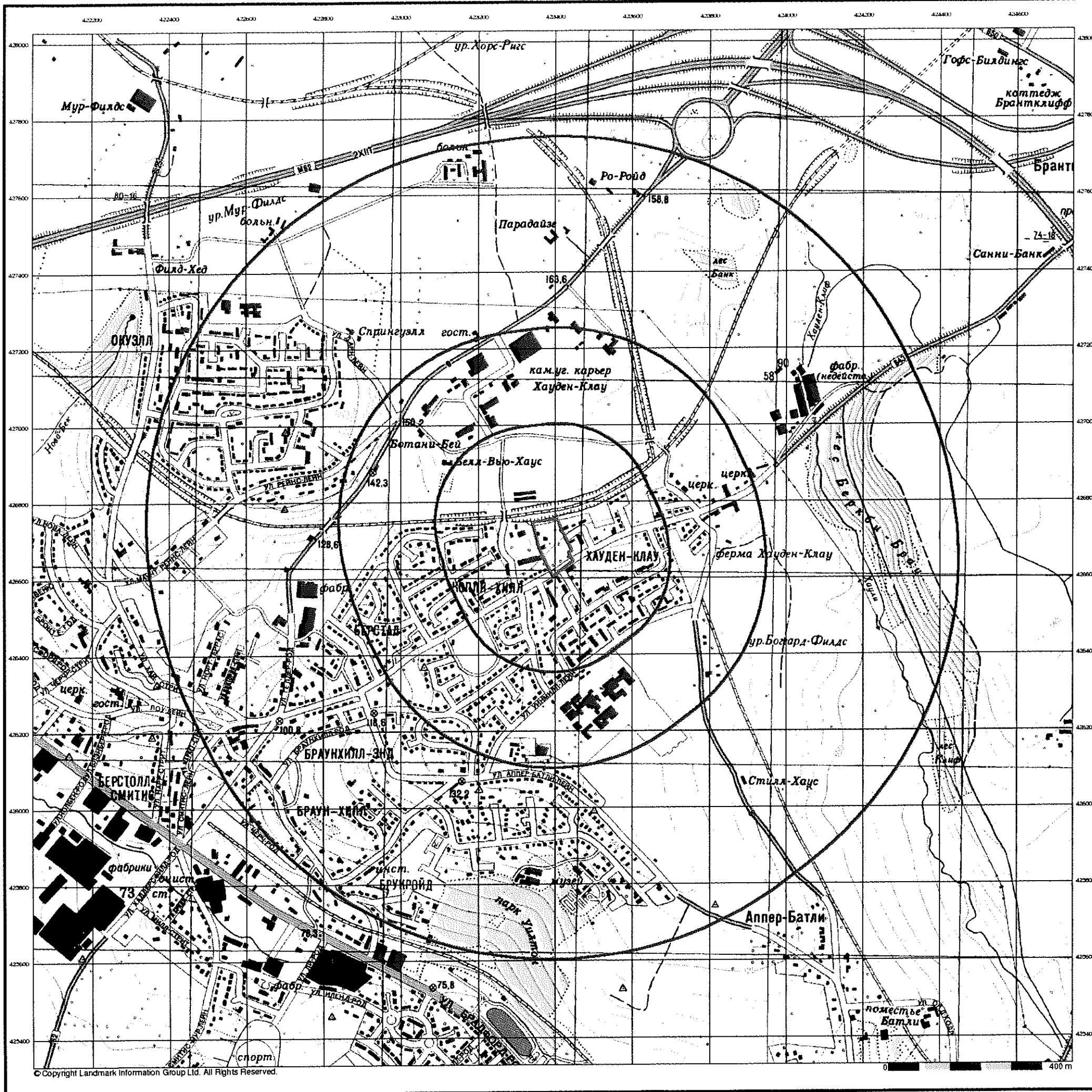

Envirocheck

LANDMARK INFORMATION GROUP

Batley

Published 1983

Source map scale - 1:10,000

These maps were produced by the Russian military during the Cold War between 1950 and 1997, and cover 103 towns and cities throughout the U.K. The maps are produced at 1:25,000, 1:10,000 and 1:5,000 scale, and show detailed land use, with colour-coded areas for development, green areas, and non-developed areas. Buildings are coloured black and important building uses (such as hospitals, post offices, factories etc.) are numbered, with a numbered key describing their use. They were produced by the Russians for the benefit of navigation, as well as strategic military sites and transport hubs, for use if they were to have invaded the U.K. The detailed information provided indicates that the areas were surveyed using land-based personnel, on the ground, in the cities that are mapped.

Map Name(s) and Date(s)

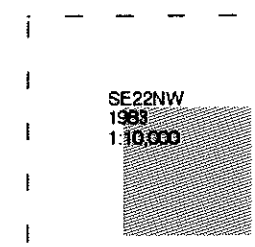

Russian Map - Slice A

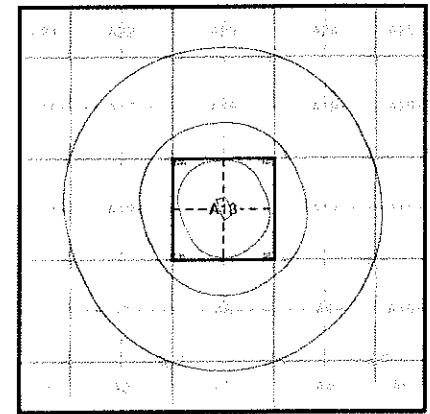

Order Details

Order Number: 226382729_1_1
 Customer Ref: 44688
 National Grid Reference: 423390, 426680
 Slice: A
 Site Area (Ha): 0.93
 Search Buffer (m): 1000

Site Details

Site at 423390, 426690

Landmark
 INFORMATION GROUP

Tel: 0844 844 9952
 Fax: 0844 844 9951
 Web: www.envirocheck.co.uk

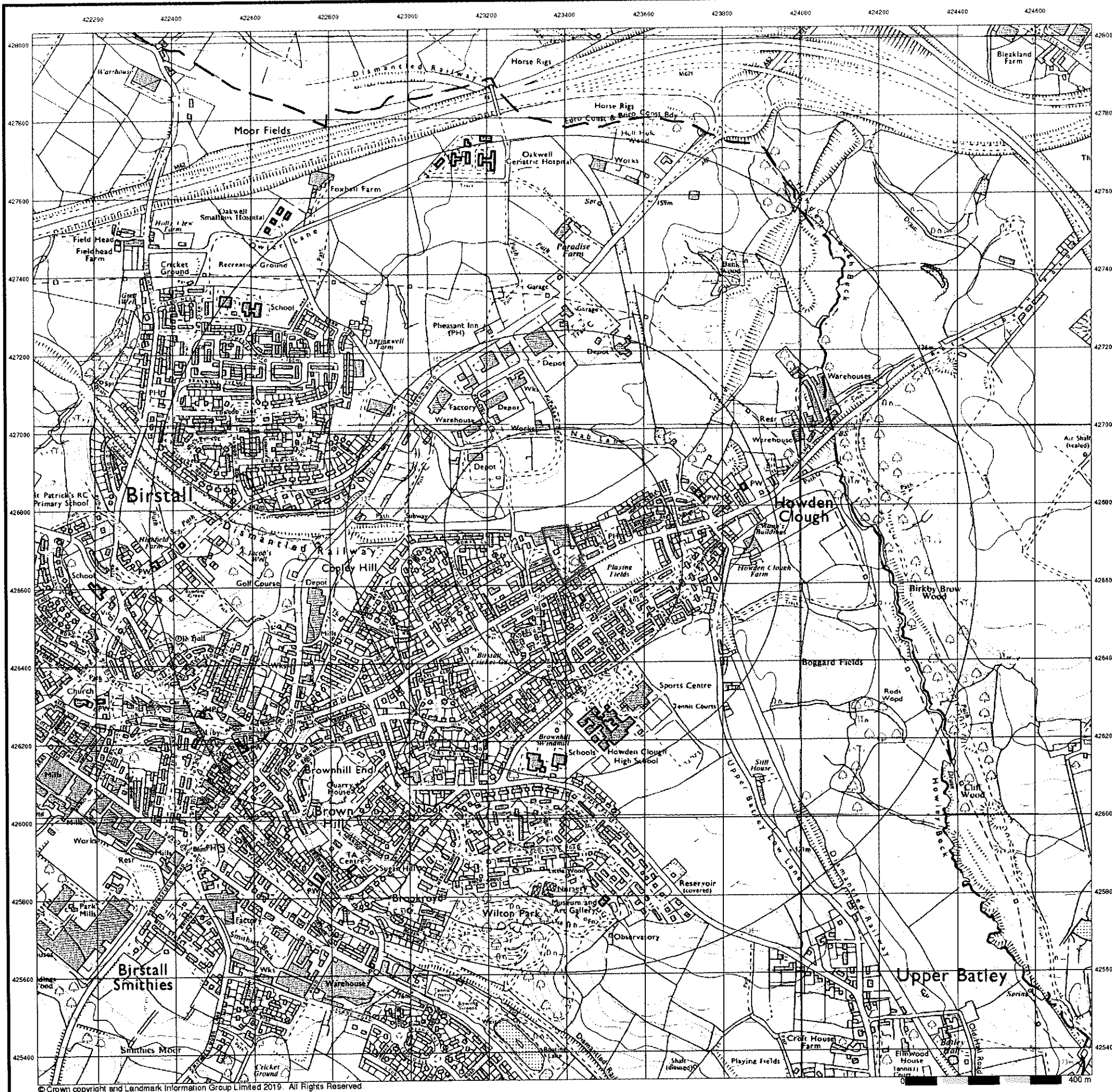

Ordnance Survey Plan
Published 1986
Source map scale - 1:10,000

The historical maps shown were reproduced from maps predominantly held at the scale adopted for England, Wales and Scotland in the 1840's. In 1854 the 1:2,500 scale was adopted for mapping urban areas; these maps were used to update the 1:10,560 maps. The published date given therefore is often some years later than the surveyed date. Before 1938, all OS maps were based on the Cassini Projection, with independent surveys of a single county or group of counties, giving rise to significant inaccuracies in outlying areas. In the late 1940's, a Provisional Edition was produced, which updated the 1:10,560 mapping from a number of sources. The maps appear unfinished - with all military camps and other strategic sites removed. These maps were initially overprinted with the National Grid. In 1970, the first 1:10,000 maps were produced using the Transverse Mercator Projection. The revision process continued until recently, with new editions appearing every 10 years or so for urban areas.

Map Name(s) and Date(s)

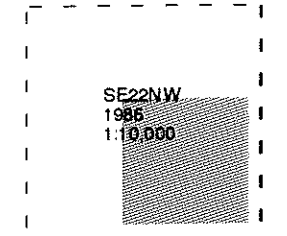

Historical Map - Slice A

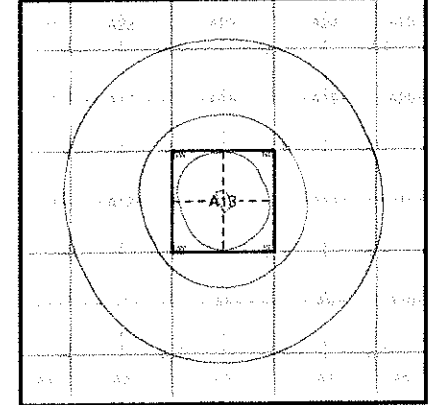

Order Details

Order Number: 226382729_1_1
 Customer Ref: 44688
 National Grid Reference: 423390, 426680
 Slice: A
 Site Area (Ha): 0.93
 Search Buffer (m): 1000

Site Details

Site at 423390, 426690

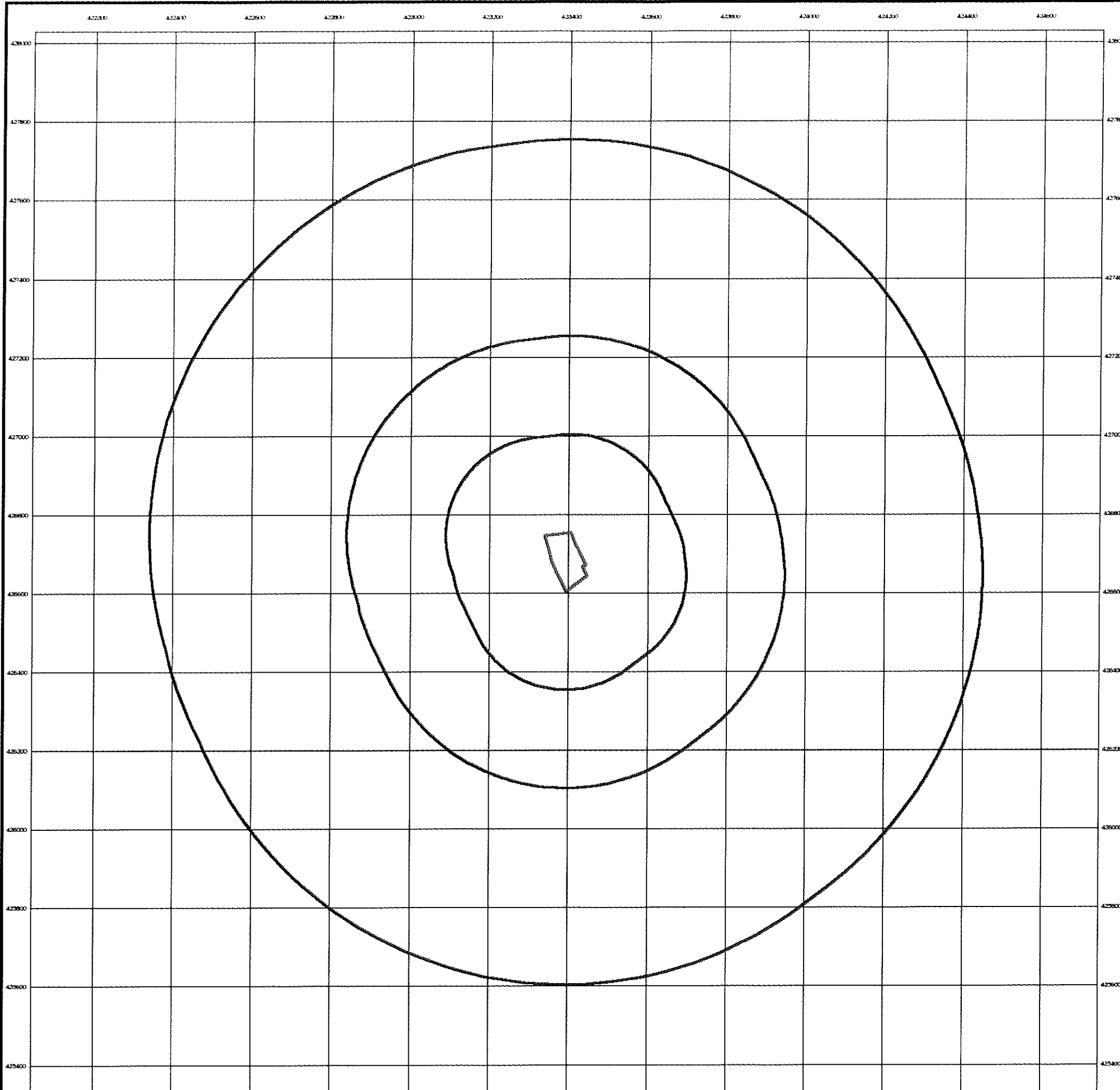

© Copyright Landmark Information Group Ltd. All Rights Reserved.

Envirocheck

LANDMARK INFORMATION GROUP

Bradford

Published 1990

Source map scale - 1:10,000

These maps were produced by the Russian military during the Cold War between 1950 and 1997, and cover 103 towns and cities throughout the U.K. The maps are produced at 1:25,000, 1:10,000 and 1:5,000 scale, and show detailed land use, with colour-coded areas for development, green areas, and non-developed areas. Buildings are coloured black and important building uses (such as hospitals, post offices, factories etc.) are numbered, with a numbered key describing their use.

They were produced by the Russians for the benefit of navigation, as well as strategic military sites and transport hubs, for use if they were to have invaded the U.K. The detailed information provided indicates that the areas were surveyed using land-based personnel, on the ground, in the cities that are mapped.

Map Name(s) and Date(s)

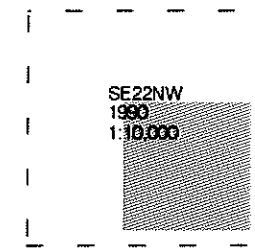

Russian Map - Slice A

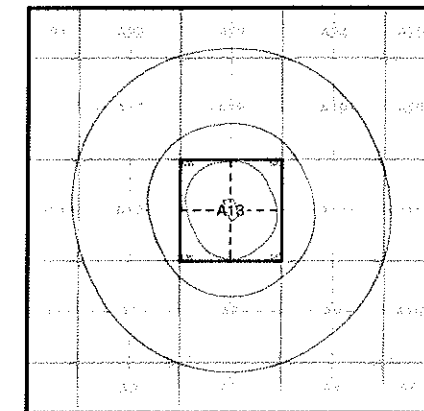

Order Details

Order Number: 226382729_1_1
 Customer Ref: 44688
 National Grid Reference: 423390, 426680
 Slice: A
 Site Area (Ha): 0.93
 Search Buffer (m): 1000

Site Details

Site at 423390, 426690

Landmark
 LANDMARK INFORMATION GROUP

Tel: 0844 844 9952
 Fax: 0844 844 9951
 Web: www.envirocheck.co.uk

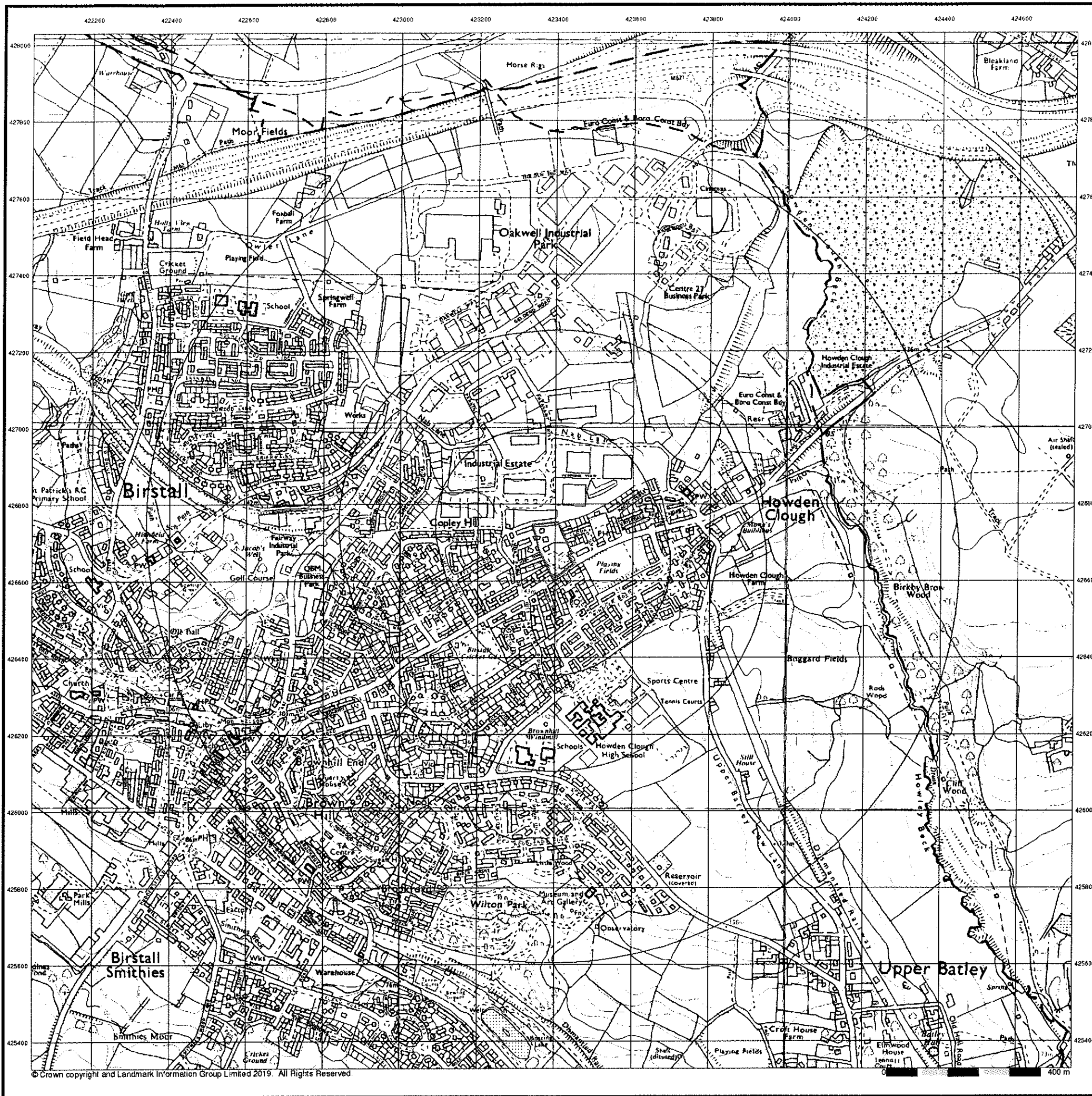

Ordnance Survey Plan Published 1995 Source map scale - 1:10,000

The historical maps shown were reproduced from maps predominantly held at the scale adopted for England, Wales and Scotland in the 1840's. In 1854 the 1:2,500 scale was adopted for mapping urban areas; these maps were used to update the 1:10,560 maps. The published date given therefore is often some years later than the surveyed date. Before 1938, all OS maps were based on the Cassini Projection, with independent surveys of a single county or group of counties, giving rise to significant inaccuracies in outlying areas. In the late 1940's, a Provisional Edition was produced, which updated the 1:10,560 mapping from a number of sources. The maps appear unfinished - with all military camps and other strategic sites removed. These maps were initially overprinted with the National Grid. In 1970, the first 1:10,000 maps were produced using the Transverse Mercator Projection. The revision process continued until recently, with new editions appearing every 10 years or so for urban areas.

Map Name(s) and Date(s)

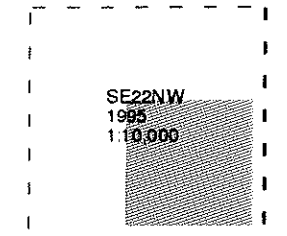

Historical Map - Slice A

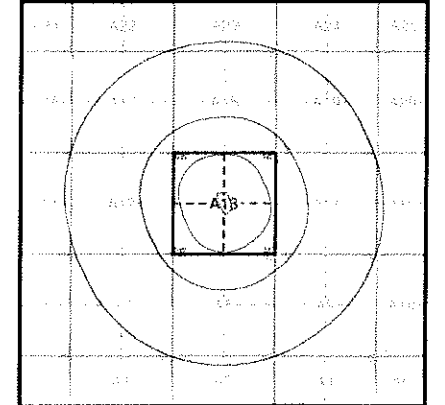

Order Details

Order Number: 226382729_1_1
 Customer Ref: 44688
 National Grid Reference: 423390, 426680
 Slice: A
 Site Area (Ha): 0.93
 Search Buffer (m): 1000

Site Details

Site at 423390, 426690

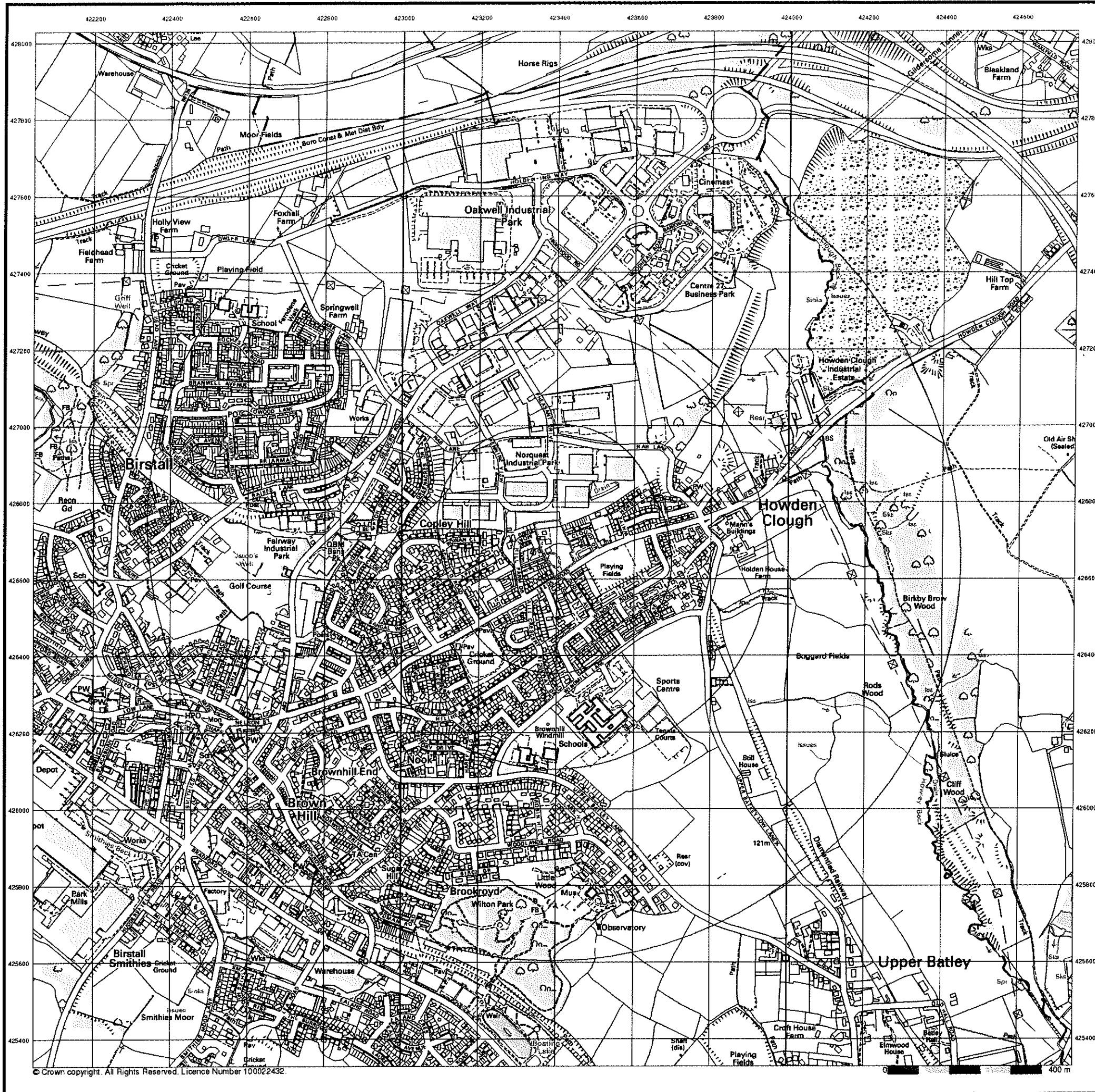

10k Raster Mapping
Published 2000
Source map scale - 1:10,000

The historical maps shown were produced from the Ordnance Survey's 1:10,000 colour raster mapping. These maps are derived from Landplan which replaced the old 1:10,000 maps originally published in 1970. The data is highly detailed showing buildings, fences and field boundaries as well as all roads, tracks and paths. Road names are also included together with the relevant road number and classification. Boundary information depiction includes county, unitary authority, district, civil parish and constituency.

Map Name(s) and Date(s)

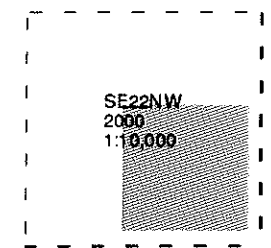

Historical Map - Slice A

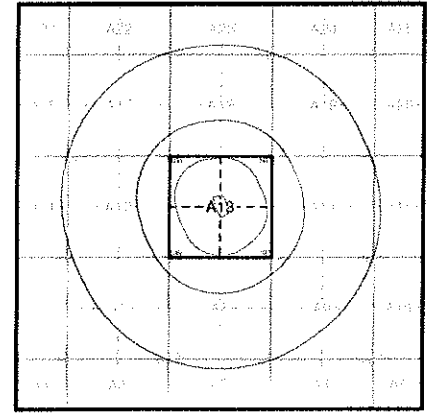

Order Details

Order Number: 226382729_1_1
 Customer Ref: 44688
 National Grid Reference: 423390, 426680
 Slice: A
 Site Area (Ha): 0.93
 Search Buffer (m): 1000

Site Details

Site at 423390, 426690

© Crown copyright. All Rights Reserved. Licence Number 100022432

10k Raster Mapping

Published 2006

Source map scale - 1:10,000

The historical maps shown were produced from the Ordnance Survey's 1:10,000 colour raster mapping. These maps are derived from Landplan which replaced the old 1:10,000 maps originally published in 1970. The data is highly detailed showing buildings, fences and field boundaries as well as all roads, tracks and paths. Road names are also included together with the relevant road number and classification. Boundary information depiction includes county, unitary authority, district, civil parish and constituency.

Map Name(s) and Date(s)

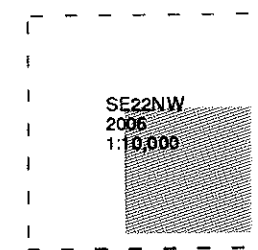

Historical Map - Slice A

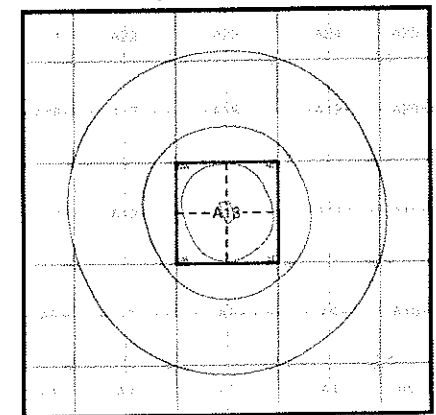

Order Details

Order Number: 226382729_1_1
Customer Ref: 44688
National Grid Reference: 423390, 426680
Slice: A
Site Area (Ha): 0.93
Search Buffer (m): 1000

Site Details

Site at 423390, 426690

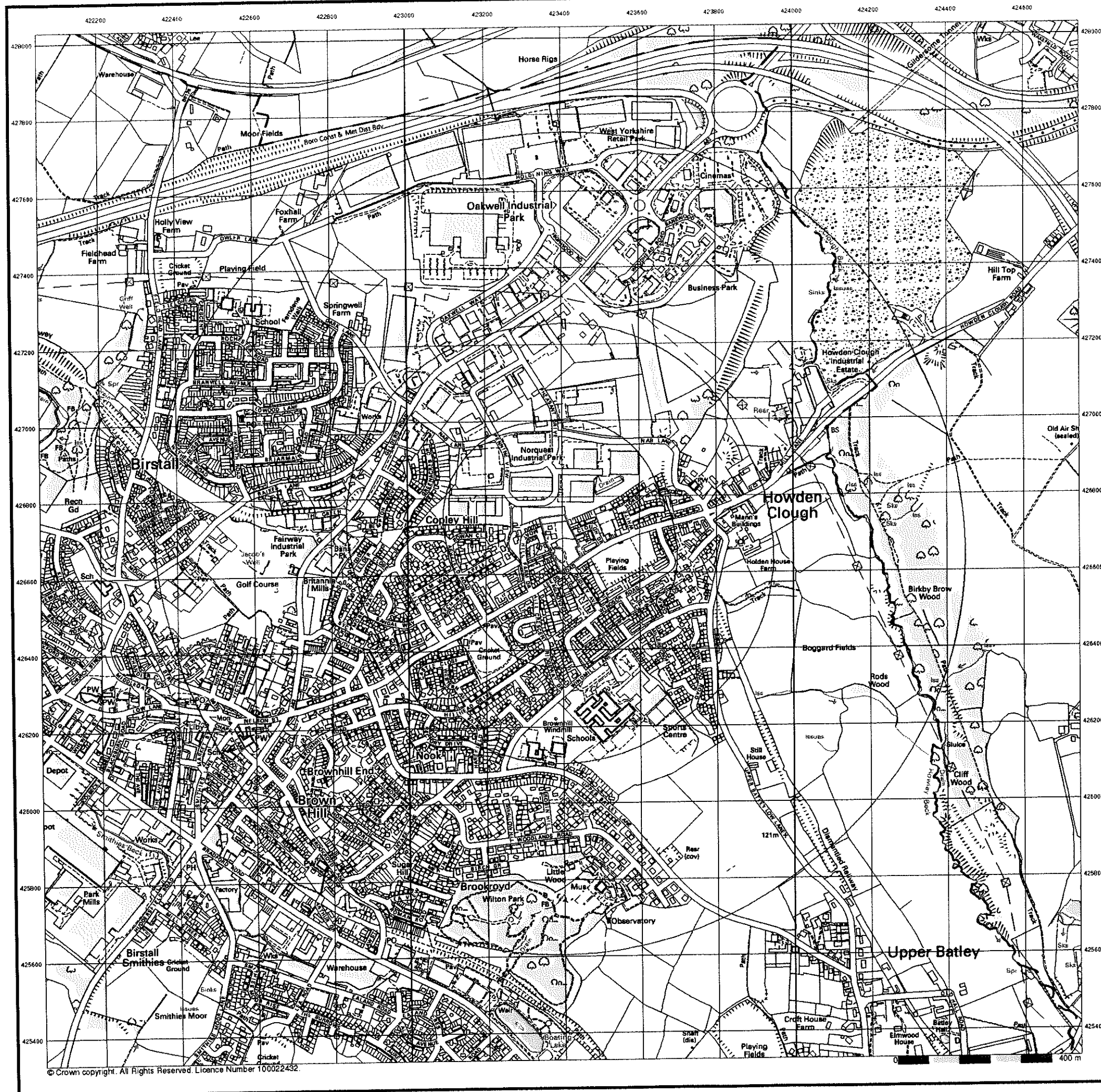

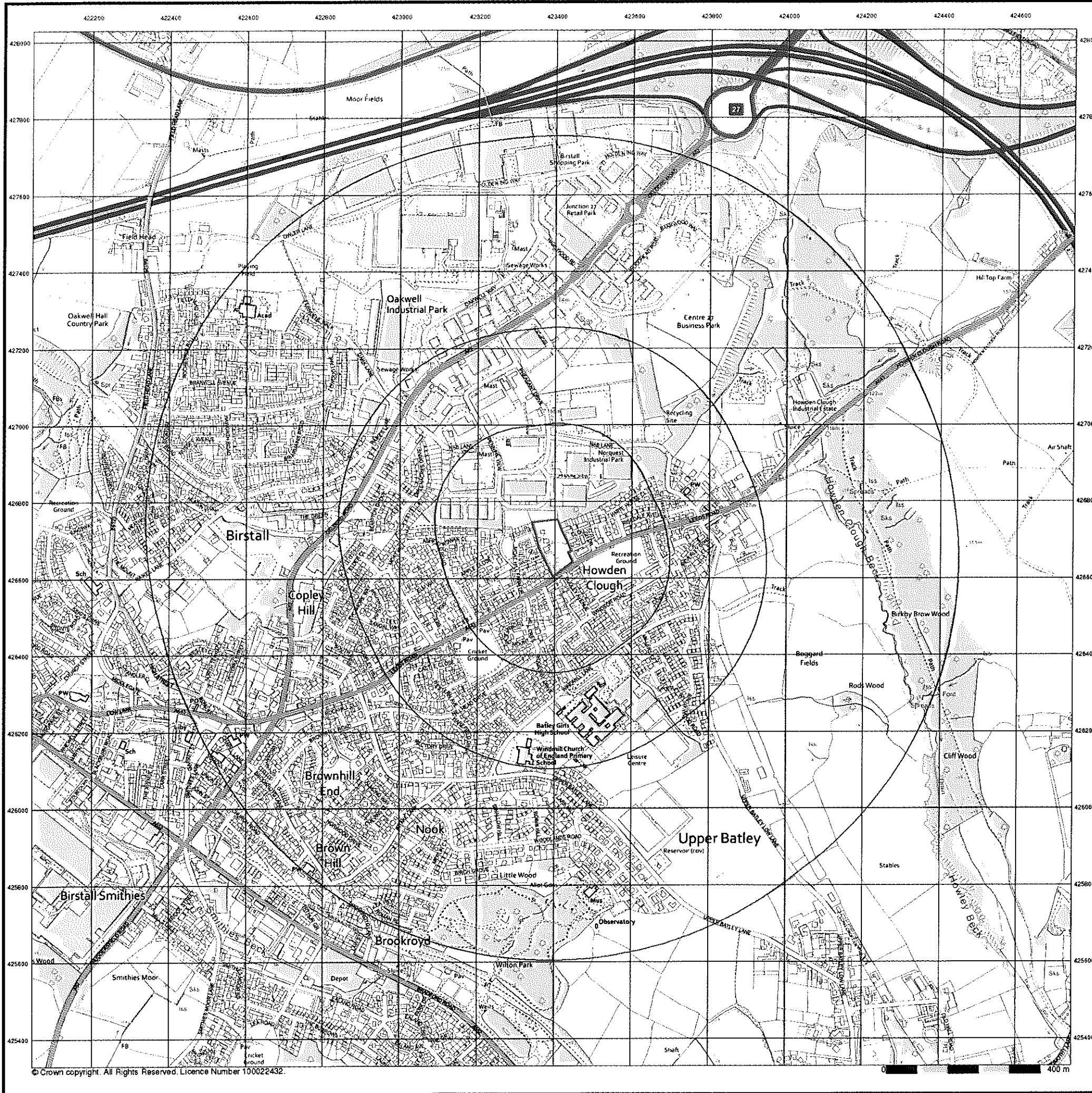

© Crown copyright. All Rights Reserved. Licence Number 100022432.

Envirocheck

LANDMARK INFORMATION GROUP

VectorMap Local

Published 2019

Source map scale - 1:10,000

VectorMap Local (Raster) is Ordnance Survey's highest detailed 'backdrop' mapping product. These maps are produced from OS's VectorMap Local, a simple vector dataset at a nominal scale of 1:10,000, covering the whole of Great Britain, that has been designed for creating graphical mapping. OS VectorMap Local is derived from large-scale information surveyed at 1:1250 scale (covering major towns and cities), 1:2500 scale (smaller towns, villages and developed rural areas), and 1:10 000 scale (mountain, moorland and river estuary areas).

Map Name(s) and Date(s)

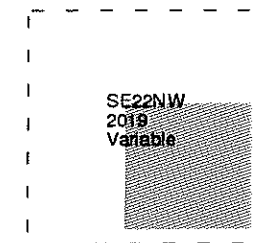

Historical Map - Slice A

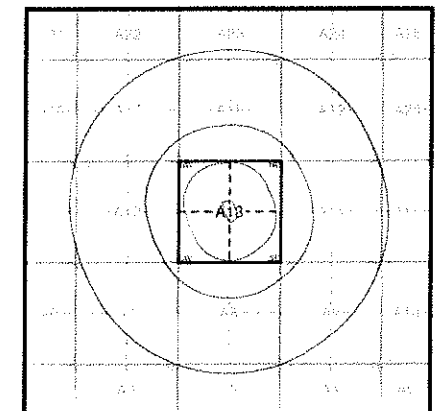

Order Details

Order Number: 226382729_1_1
 Customer Ref: 44688
 National Grid Reference: 423390, 426680
 Slice: A
 Site Area (Ha): 0.93
 Search Buffer (m): 1000

Site Details

Site at 423390, 426690

Landmark
 LANDMARK INFORMATION GROUP

Tel: 0844 844 9952
 Fax: 0844 844 9951
 Web: www.envirocheck.co.uk

Historical Mapping Legends

Ordnance Survey County Series and Ordnance Survey Plan 1:2,500

Quarry **Gravel Pit** **Sand Pit**
Clay Pit **Shingle** **Refuse Heap**
Sloping Masonry **Flat Rock**
Marsh **Reeds** **Osiers**
Rough Pasture **Furze** **Wood**
Mixed Wood **Brushwood** **Orchard**
Fir **Ford** **Stepping Stones**
Ferry **Waterfall** **Lock**
Trig. Station **Altitude at Trig. Station**
Bench Mark **Surface Level**
Arrow denotes flow of water **Antiquities (site of)**
Cutting **Embankment**
Railway crossing Road **Level Crossing** **Road crossing Railway**
Railway crossing River or Canal **Road over single stream** **Road over River or Canal**
County Boundary (Geographical)
County & Civil Parish Boundary
Administrative County & Civil Parish Boundary
County Borough Boundary (England)
County Burgh Boundary (Scotland)
Boundary Post or Stone **Police Call Box**
B.R. Bridle Road **Pump**
E.P. Electricity Pylon **S.P. Signal Post**
F.B. Foot Bridge **Sl. Sluice**
F.P. Foot Path **Spr. Spring**
G.P. Guide Post or Board **T.C.B. Telephone Call Box**
M.S. Mile Stone **Tr. Trough**
M.P. M.R. Mooring Post or Ring **W. Well**

Ordnance Survey Plan, Additional SIMs and Supply of Unpublished Survey Information 1:2,500 and 1:1,250

Inactive Quarry, Chalk Pit or Clay Pit **Active Quarry, Chalk Pit or Clay Pit**
Rock **Boulders**
Cliff **Slopes** **Top**
Roofed Building **Glazed Roof Building**
Sloping Masonry **Archway**
Non-Coniferous Tree (surveyed) **Coniferous Tree (surveyed)**
Non-Coniferous Trees (not surveyed) **Coniferous Trees (not surveyed)**
Orchard Tree **Scrub** **Bracken**
Coppice, Osier **Reeds** **Marsh, Saltings**
Rough Grassland **Heath** **Culvert**
Direction of water flow **Bench Mark** **Antiquity (site of)**
Cave Entrance **Triangulation Station** **Electricity Pylon**
Electricity Transmission Line
County Boundary (Geographical)
County & Civil Parish Boundary
Civil Parish Boundary
Admin. County or County Bor. Boundary
London Borough Boundary
Symbol marking point where boundary mereing changes
BH Beer House **P Pillar, Pole or Post**
BP, BS Boundary Post or Stone **PO Post Office**
Cn, C Capstan, Crane **PC Public Convenience**
Chy Chimney **PH Public House**
D Fn Drinking Fountain **Pp Pump**
EI P Electricity Pillar or Post **SB, S Br Signal Box or Bridge**
FAP Fire Alarm Pillar **SP, SL Signal Post or Light**
FB Foot Bridge **Spr Spring**
GP Guide Post **Tk Tank or Track**
H Hydrant or Hydraulic **TCB Telephone Call Box**
LC Level Crossing **TCP Telephone Call Post**
MH Manhole **Tr Trough**
MP Mile Post or Mooring Post **Wr Pt, Wr T Water Point, Water Tap**
MS Mile Stone **W Well**
NTL Normal Tidal Limit **Wd Pp Wind Pump**

Large-Scale National Grid Data 1:2,500 and 1:1,250

Cliff **Slopes** **Top**
Rock **Rock (scattered)**
Boulders **Boulders (scattered)**
Positioned Boulder **Scree**
Non-Coniferous Tree (surveyed) **Coniferous Tree (surveyed)**
Non-Coniferous Trees (not surveyed) **Coniferous Trees (not surveyed)**
Orchard Tree **Scrub** **Bracken**
Coppice, Osier **Reeds** **Marsh, Saltings**
Rough Grassland **Heath** **Culvert**
Direction of water flow **Triangulation Station** **Antiquity (site of)**
Electricity Transmission Line **Electricity Pylon**
Bench Mark **Buildings with Building Seed**
Roofed Building **Glazed Roof Building**
Civil parish/community boundary
District boundary
County boundary
Boundary post/stone
Boundary mereing symbol (note: these always appear in opposed pairs or groups of three)
Bks Barracks **P Pillar, Pole or Post**
Bty Battery **PO Post Office**
Cemy Cemetery **PC Public Convenience**
Chy Chimney **Pp Pump**
Cis Cistem **Ppg Sta Pumping Station**
Dismtd Rly Dismantled Railway **PW Place of Worship**
EI Gen Sta Electricity Generating Station **Sewage Ppg Sta Sewage Pumping Station**
EI P Electricity Pole, Pillar **SB, S Br Signal Box or Bridge**
EI Sub Sta Electricity Sub Station **SP, SL Signal Post or Light**
FB Filter Bed **Spr Spring**
Fn / D Fn Fountain / Drinking Ftn. **Tk Tank or Track**
Gas Gov Gas Valve Compound **Tr Trough**
GVC Gas Governor **Wd Pp Wind Pump**
GP Guide Post **Wr Pt, Wr T Water Point, Water Tap**
MH Manhole **Wks Works (building or area)**
MP, MS Mile Post or Mile Stone **W Well**

Envirocheck

LANDMARK INFORMATION GROUP

Historical Mapping & Photography included:

Mapping Type	Scale	Date	Pg
Yorkshire	1:2,500	1893 - 1894	2
Yorkshire	1:2,500	1907 - 1908	3
Yorkshire	1:2,500	1922	4
Yorkshire	1:2,500	1933 - 1938	5
Ordnance Survey Plan	1:2,500	1956	6
Ordnance Survey Plan	1:1,250	1971	7
Ordnance Survey Plan	1:2,500	1972 - 1974	8
Supply of Unpublished Survey Information	1:1,250	1973	9
Supply of Unpublished Survey Information	1:2,500	1974	10
Supply of Unpublished Survey Information	1:1,250	1974	11
Additional SIMs	1:1,250	1977 - 1992	12
Additional SIMs	1:2,500	1987	13
Additional SIMs	1:2,500	1988	14
Additional SIMs	1:1,250	1988 - 1990	15
Additional SIMs	1:1,250	1990 - 1991	16
Additional SIMs	1:2,500	1990	17
Ordnance Survey Plan	1:1,250	1991 - 1992	18
Large-Scale National Grid Data	1:1,250	1993	19
Large-Scale National Grid Data	1:1,250	1994 - 1995	20
Historical Aerial Photography	1:2,500	1999	21

Historical Map - Segment A13

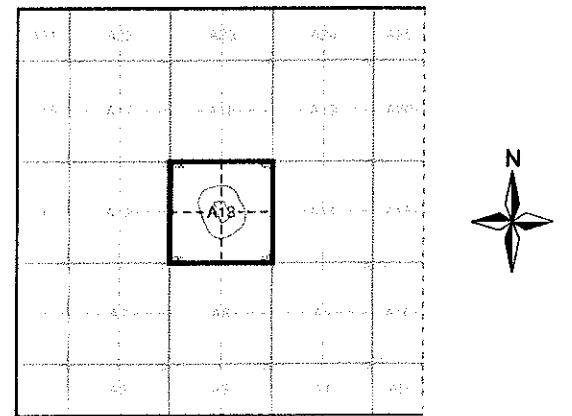

Order Details

Order Number: 226382729_1_1
 Customer Ref: 44688
 National Grid Reference: 423390, 426680
 Slice: A
 Site Area (Ha): 0.93
 Search Buffer (m): 100

Site Details

Site at 423390, 426690

Landmark
 LANDMARK INFORMATION GROUP

Tel: 0844 844 9952
 Fax: 0844 844 9951
 Web: www.envirocheck.co.uk

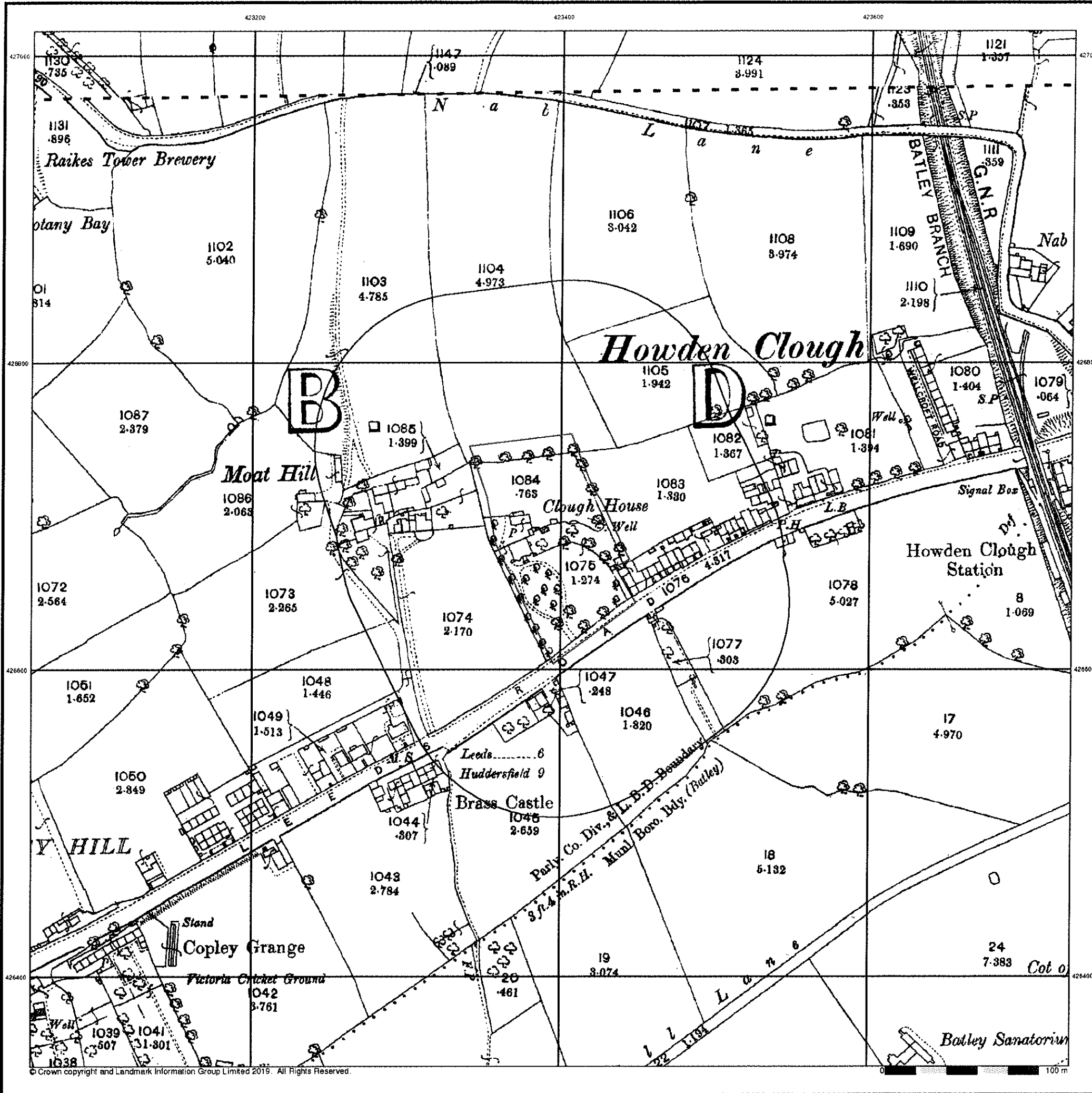

Envirocheck

LANDMARK INFORMATION GROUP

Yorkshire

Published 1893 - 1894

Source map scale - 1:2,500

The historical maps shown were reproduced from maps predominantly held at the scale adopted for England, Wales and Scotland in the 1840's. In 1854 the 1:2,500 scale was adopted for mapping urban areas and by 1896 it covered the whole of what were considered to be the cultivated parts of Great Britain. The published date given below is often some years later than the surveyed date. Before 1938, all OS maps were based on the Cassini Projection, with independent surveys of a single county or group of counties, giving rise to significant inaccuracies in outlying areas.

Map Name(s) and Date(s)

232 03	1893	1:2,500
232 07	1894	1:2,500

Historical Map - Segment A13

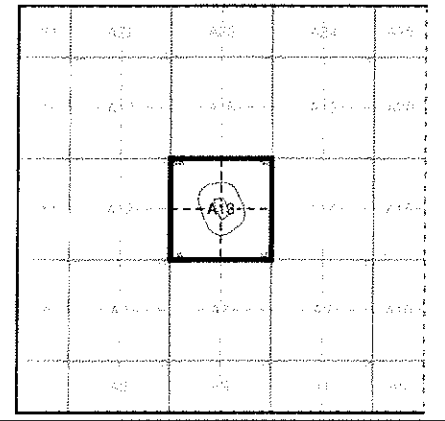

Order Details

Order Number: 226382729_1_1
 Customer Ref: 44688
 National Grid Reference: 423390, 426680
 Slice: A
 Site Area (Ha): 0.93
 Search Buffer (m): 100

Site Details

Site at 423390, 426690

Landmark
 INFORMATION GROUP

Tel: 0844 844 9952
 Fax: 0844 844 9951
 Web: www.envirocheck.co.uk

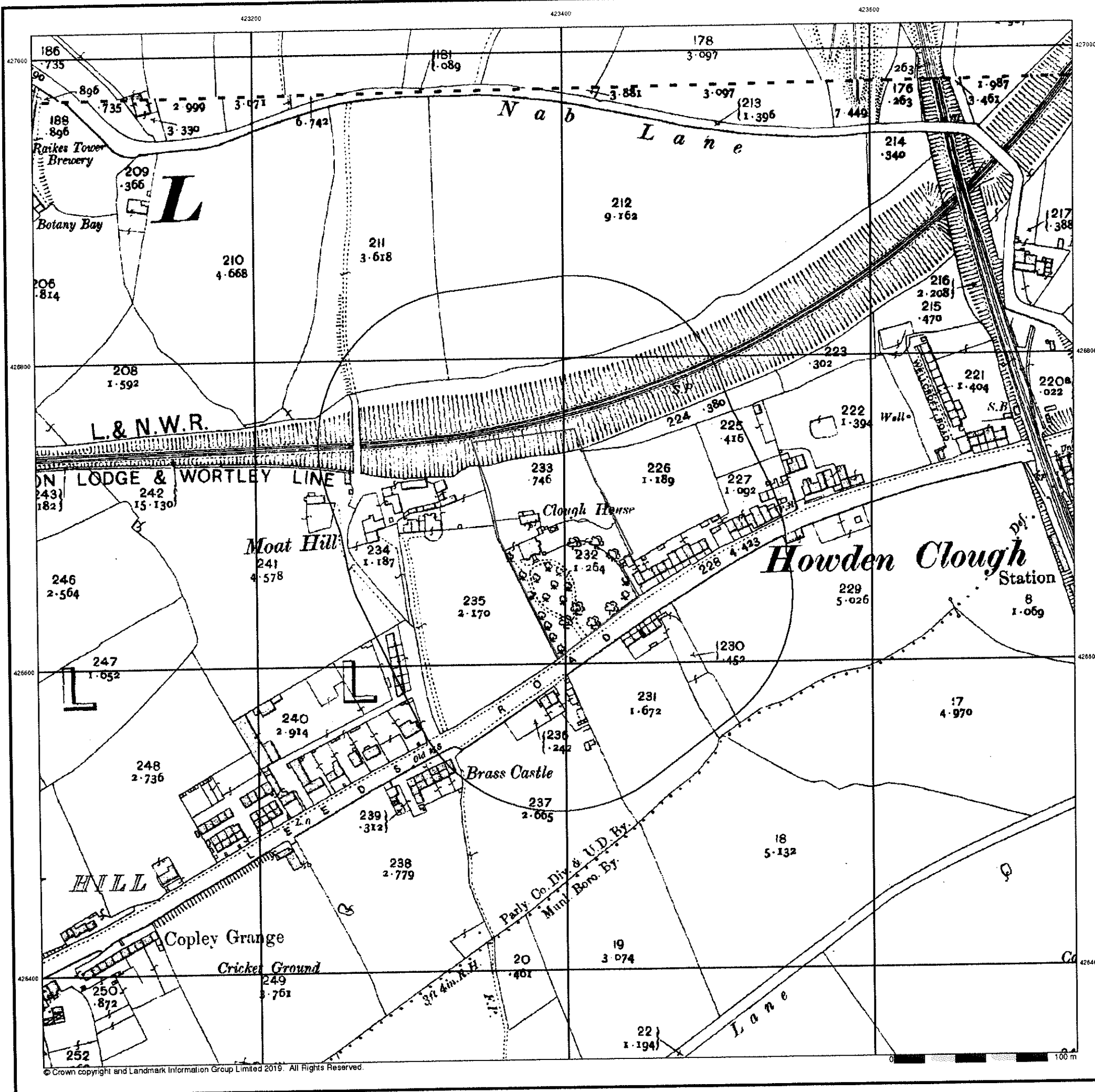

Envirocheck

LANDMARK INFORMATION GROUP

Yorkshire

Published 1907 - 1908

Source map scale - 1:2,500

The historical maps shown were reproduced from maps predominantly held at the scale adopted for England, Wales and Scotland in the 1840's. In 1854 the 1:2,500 scale was adopted for mapping urban areas and by 1896 it covered the whole of what were considered to be the cultivated parts of Great Britain. The published date given below is often some years later than the surveyed date. Before 1938, all OS maps were based on the Cassini Projection, with independent surveys of a single county or group of counties, giving rise to significant inaccuracies in outlying areas.

Map Name(s) and Date(s)

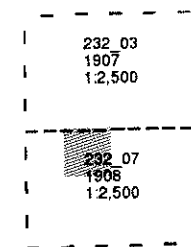

Historical Map - Segment A13

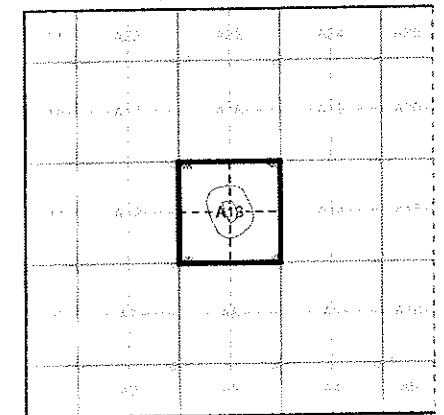

Order Details

Order Number: 226382729_1_1
 Customer Ref: 44688
 National Grid Reference: 423390, 426680
 Slice: A
 Site Area (Ha): 0.93
 Search Buffer (m): 100

Site Details

Site at 423390, 426690

Landmark
 LANDMARK INFORMATION GROUP

Tel: 0844 844 9952
 Fax: 0844 844 9951
 Web: www.envirocheck.co.uk

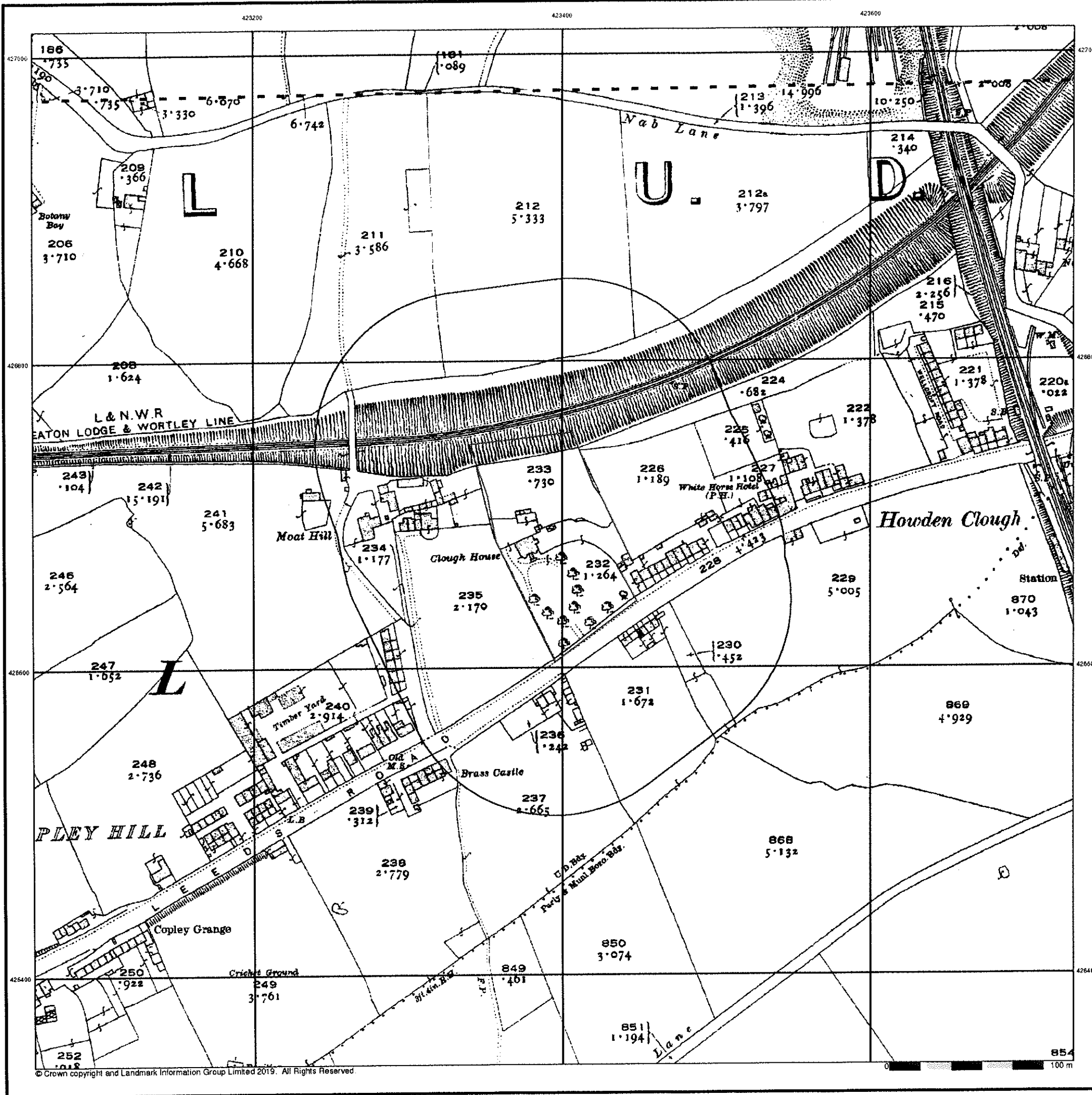

Envirocheck

LANDMARK INFORMATION GROUP

Yorkshire

Published 1922

Source map scale - 1:2,500

The historical maps shown were reproduced from maps predominantly held at the scale adopted for England, Wales and Scotland in the 1840's. In 1854 the 1:2,500 scale was adopted for mapping urban areas and by 1896 it covered the whole of what were considered to be the cultivated parts of Great Britain. The published date given below is often some years later than the surveyed date. Before 1938, all OS maps were based on the Cassini Projection, with independent surveys of a single county or group of counties, giving rise to significant inaccuracies in outlying areas.

Map Name(s) and Date(s)

232_03	1922	1:2,500
232_07	1922	1:2,500

Historical Map - Segment A13

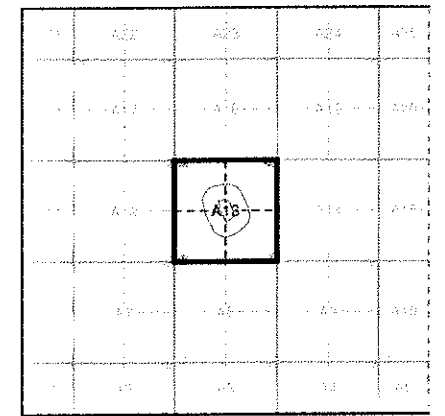

Order Details

Order Number: 226382729_1_1
 Customer Ref: 44688
 National Grid Reference: 423390, 426680
 Slice: A
 Site Area (Ha): 0.93
 Search Buffer (m): 100

Site Details

Site at 423390, 426690

Landmark
 LANDMARK INFORMATION GROUP

Tel: 0844 844 9952
 Fax: 0844 844 9951
 Web: www.envirocheck.co.uk

Yorkshire

Published 1933 - 1938

Source map scale - 1:2,500

The historical maps shown were reproduced from maps predominantly held at the scale adopted for England, Wales and Scotland in the 1840's. In 1854 the 1:2,500 scale was adopted for mapping urban areas and by 1896 it covered the whole of what were considered to be the cultivated parts of Great Britain. The published date given below is often some years later than the surveyed date. Before 1938, all OS maps were based on the Cassini Projection, with independent surveys of a single county or group of counties, giving rise to significant inaccuracies in outlying areas.

Map Name(s) and Date(s)

232 03
1938
1:2,500
232 07
1933
1:2,500

Historical Map - Segment A13

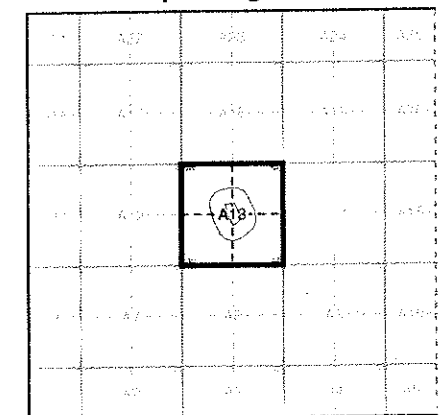

Order Details

Order Number: 226382729_1_1
 Customer Ref: 44688
 National Grid Reference: 423390, 426680
 Slice: A
 Site Area (Ha): 0.93
 Search Buffer (m): 100

Site Details

Site at 423390, 426690

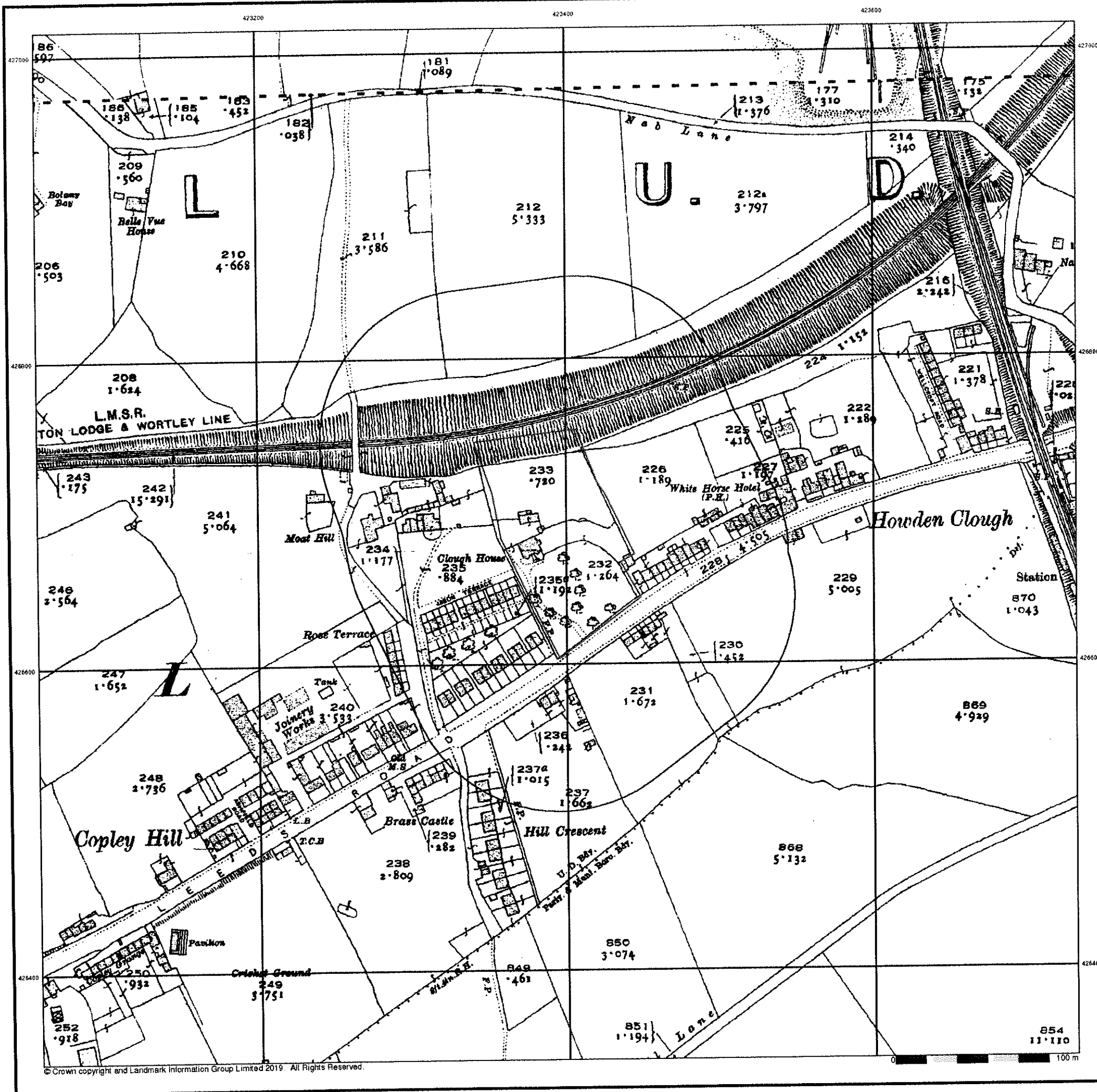

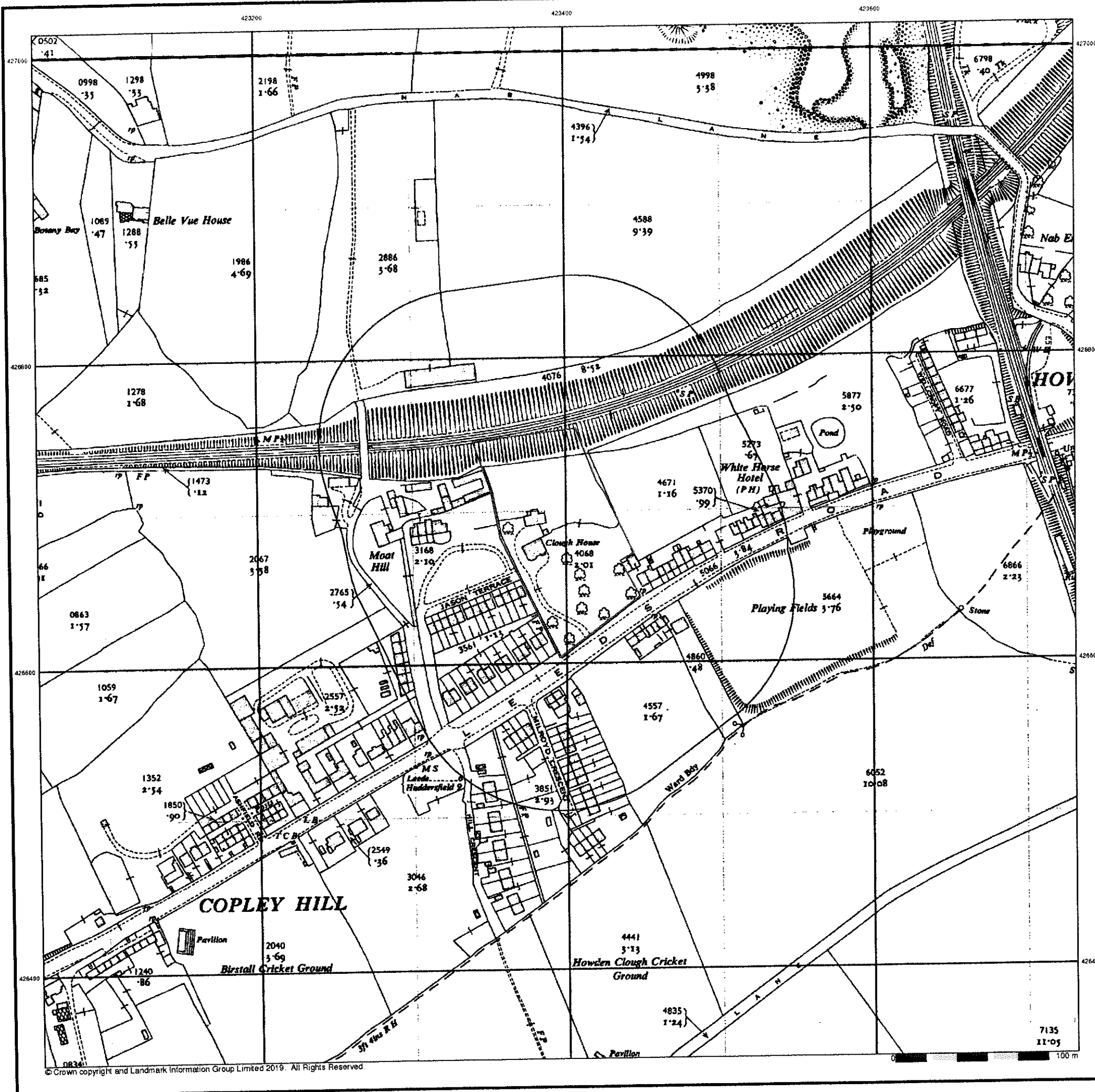

Envirocheck

LANDMARK INFORMATION GROUP

Ordnance Survey Plan

Published 1956

Source map scale - 1:2,500

The historical maps shown were reproduced from maps predominantly held at the scale adopted for England, Wales and Scotland in the 1840's. In 1854 the 1:2,500 scale was adopted for mapping urban areas and by 1896 it covered the whole of what were considered to be the cultivated parts of Great Britain. The published date given below is often some years later than the surveyed date. Before 1938, all OS maps were based on the Cassini Projection, with independent surveys of a single county or group of counties, giving rise to significant inaccuracies in outlying areas.

Map Name(s) and Date(s)

SE2327
1956
1:2,500

SE2326
1956
1:2,500

Historical Map - Segment A13

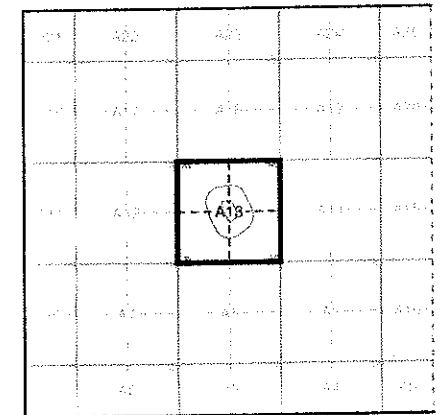

Order Details

Order Number: 226382729_1_1
 Customer Ref: 44688
 National Grid Reference: 423390, 426680
 Slice: A
 Site Area (Ha): 0.93
 Search Buffer (m): 100

Site Details

Site at 423390, 426690

Landmark
 LANDMARK INFORMATION GROUP

Tel: 0844 844 9952
 Fax: 0844 844 9951
 Web: www.envirocheck.co.uk

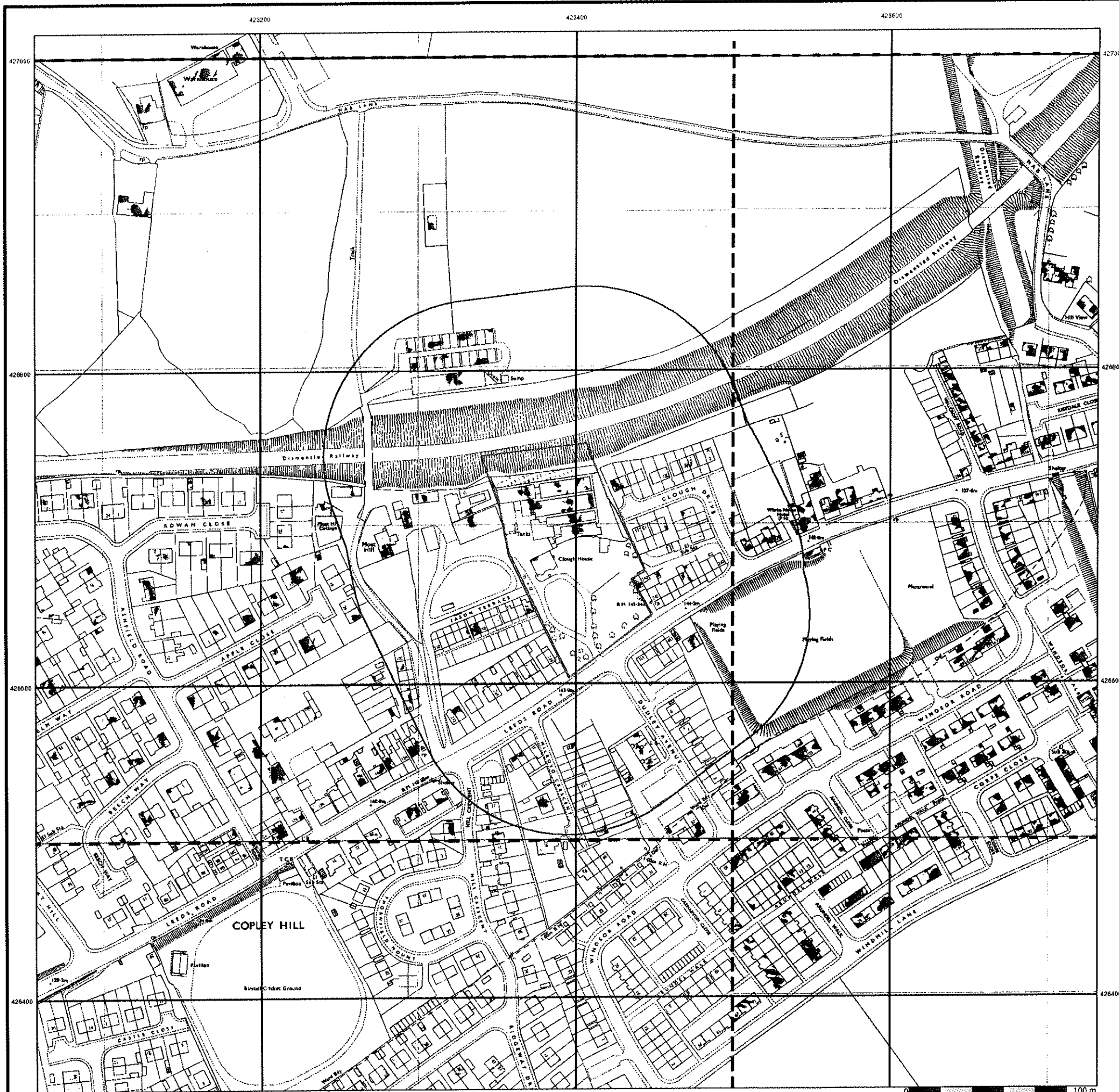

Envirocheck

LANDMARK INFORMATION GROUP

**Ordnance Survey Plan
Published 1971**

Source map scale - 1:1,250

The historical maps shown were reproduced from maps predominantly held at the scale adopted for England, Wales and Scotland in the 1840's. In 1854 the 1:2,500 scale was adopted for mapping urban areas and by 1896 it covered the whole of what were considered to be the cultivated parts of Great Britain. The published date given below is often some years later than the surveyed date. Before 1938, all OS maps were based on the Cassini Projection, with independent surveys of a single county or group of counties, giving rise to significant inaccuracies in outlying areas.

Map Name(s) and Date(s)

E2327SW
971
1:1,250

E2326NWSE2326NE
971 1971
1:1,250 1:1,250

E2326SWSE2326SE
971 1971
1:1,250 1:1,250

Historical Map - Segment A13

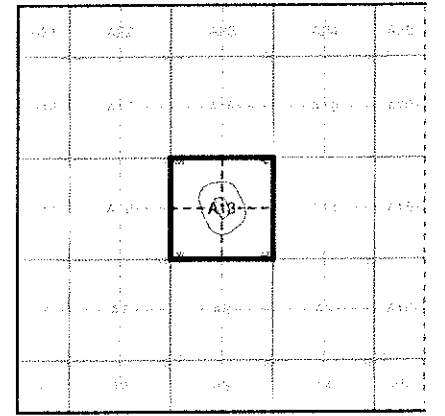

Order Details

Order Number: 226382729_1_1
 Customer Ref: 44688
 National Grid Reference: 423390, 426680
 Slice: A
 Site Area (Ha): 0.93
 Search Buffer (m): 100

Site Details

Site at 423390, 426690

Landmark
 LANDMARK INFORMATION GROUP

Tel: 0844 844 9952
 Fax: 0844 844 9951
 Web: www.envirocheck.co.uk

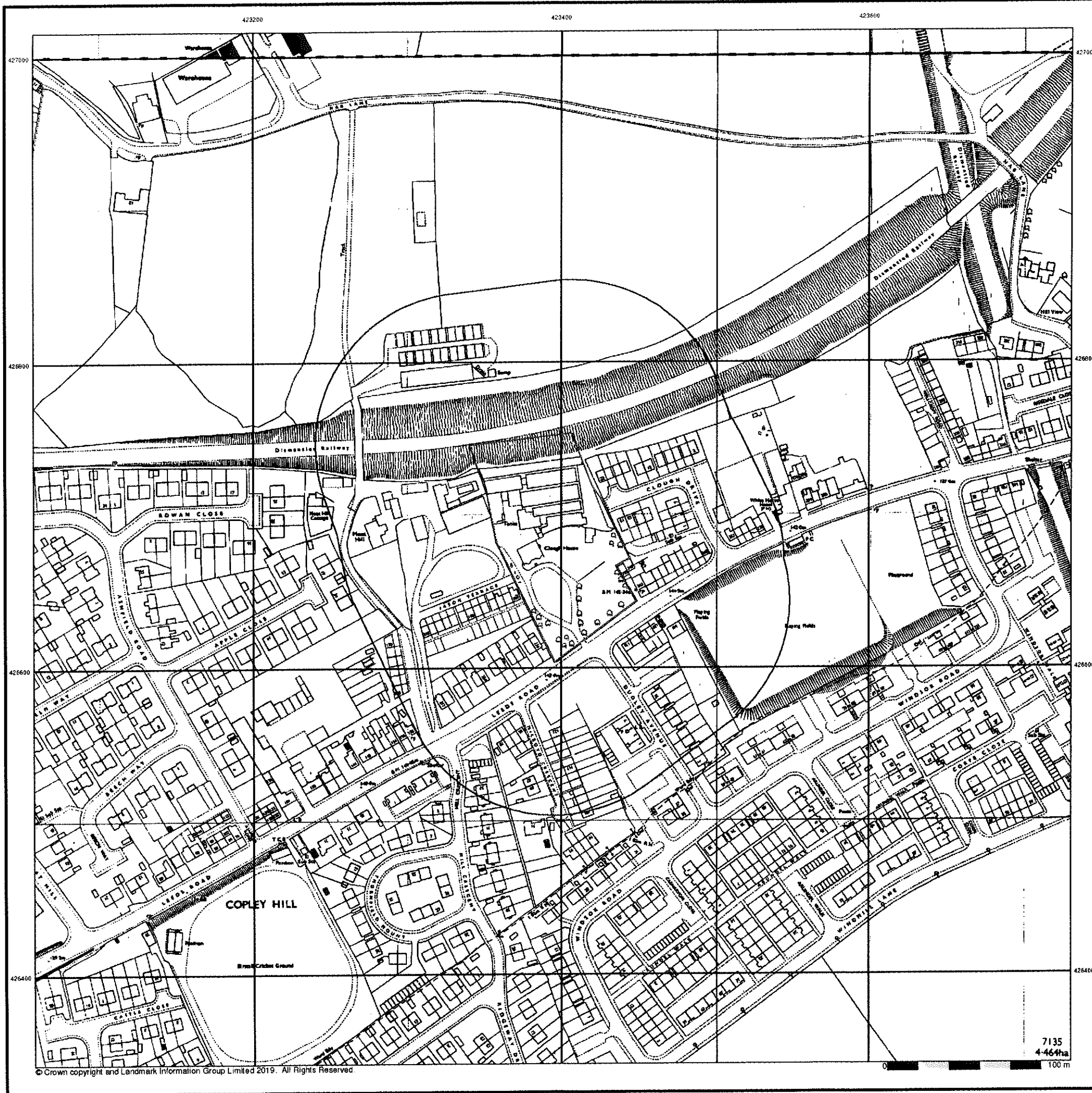

Envirocheck®

● LANDMARK INFORMATION GROUP

Ordnance Survey Plan

Published 1972 - 1974

Source map scale - 1:2,500

The historical maps shown were reproduced from maps predominantly held at the scale adopted for England, Wales and Scotland in the 1840's. In 1854 the 1:2,500 scale was adopted for mapping urban areas and by 1896 it covered the whole of what were considered to be the cultivated parts of Great Britain. The published date given below is often some years later than the surveyed date. Before 1938, all OS maps were based on the Cassini Projection, with independent surveys of a single county or group of counties, giving rise to significant inaccuracies in outlying areas.

Map Name(s) and Date(s)

SE2327	1974	1:2,500
SE2326	1972	1:2,500

Historical Map - Segment A13

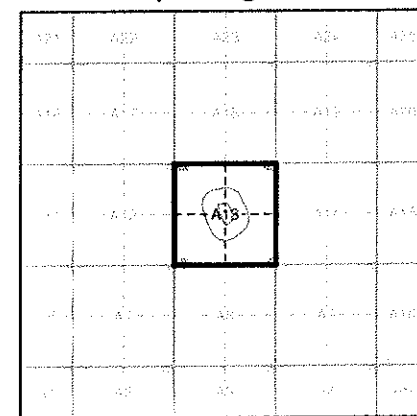

Order Details

Order Number: 226382729_1_1
 Customer Ref: 44688
 National Grid Reference: 423390, 426680
 Slice: A
 Site Area (Ha): 0.93
 Search Buffer (m): 100

Site Details

Site at 423390, 426690

Landmark
 ● LANDMARK INFORMATION GROUP

Tel: 0844 844 9952
 Fax: 0844 844 9951
 Web: www.envirocheck.co.uk

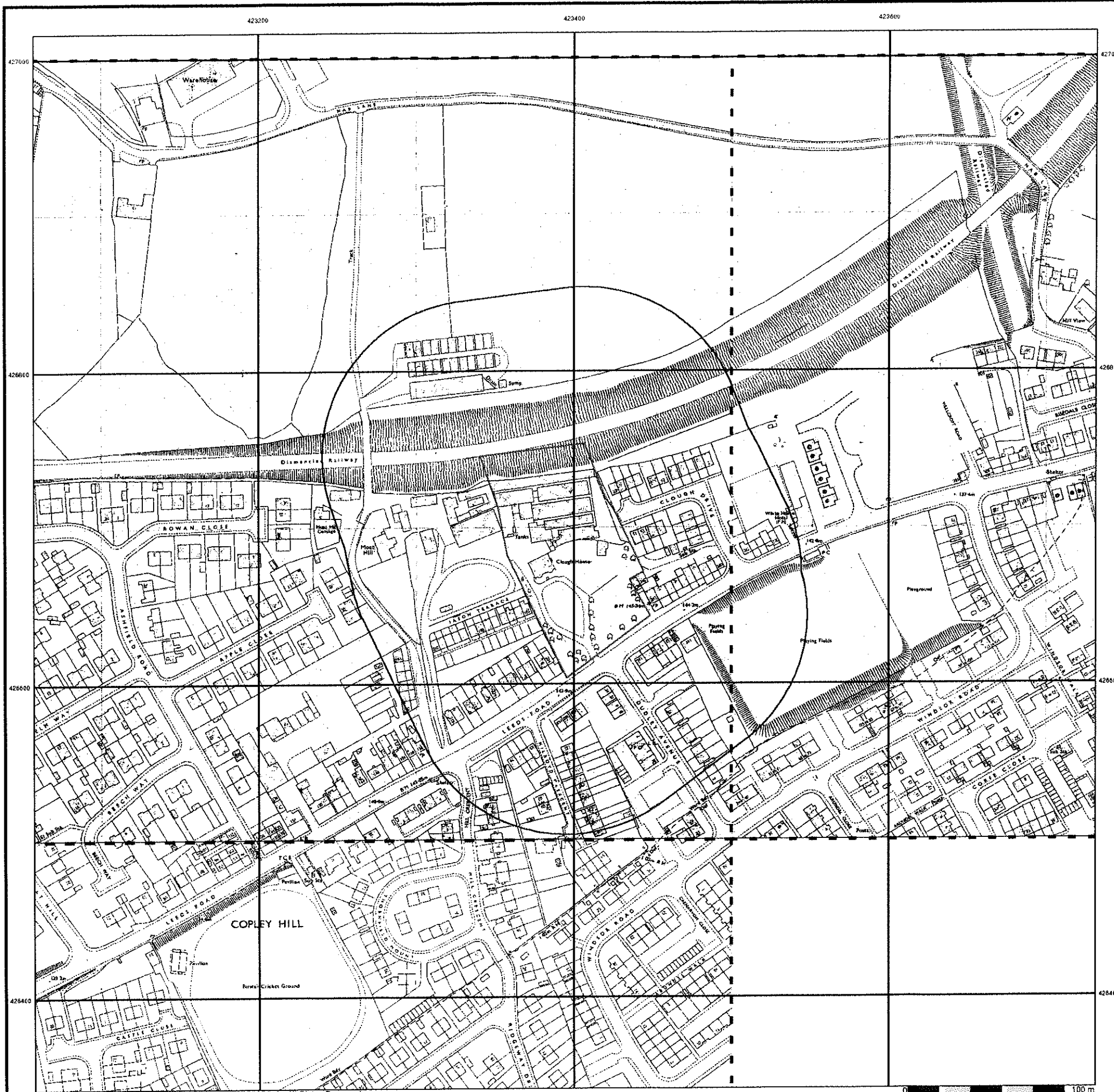

Supply of Unpublished Survey Information

Published 1973

Source map scale - 1:1,250

SUSI maps (Supply of Unpublished Survey Information) were produced between 1972 and 1977, mainly for internal use at Ordnance Survey. These were more of a 'work-in-progress' plan as they showed updates of individual areas on a map. These maps were unpublished, and they do not represent a single moment in time. They were produced at both 1:2,500 and 1:1,250 scales.

Map Name(s) and Date(s)

SE2326NW 1973 1:1,250	SE2326NE 1973 1:1,250
SE2326SW 1973 1:1,250	

Historical Map - Segment A13

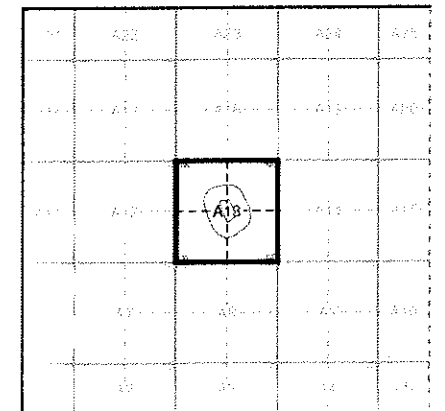

Order Details

Order Number: 226382729_1_1
 Customer Ref: 44688
 National Grid Reference: 423390, 426680
 Slice: A
 Site Area (Ha): 0.93
 Search Buffer (m): 100

Site Details

Site at 423390, 426690

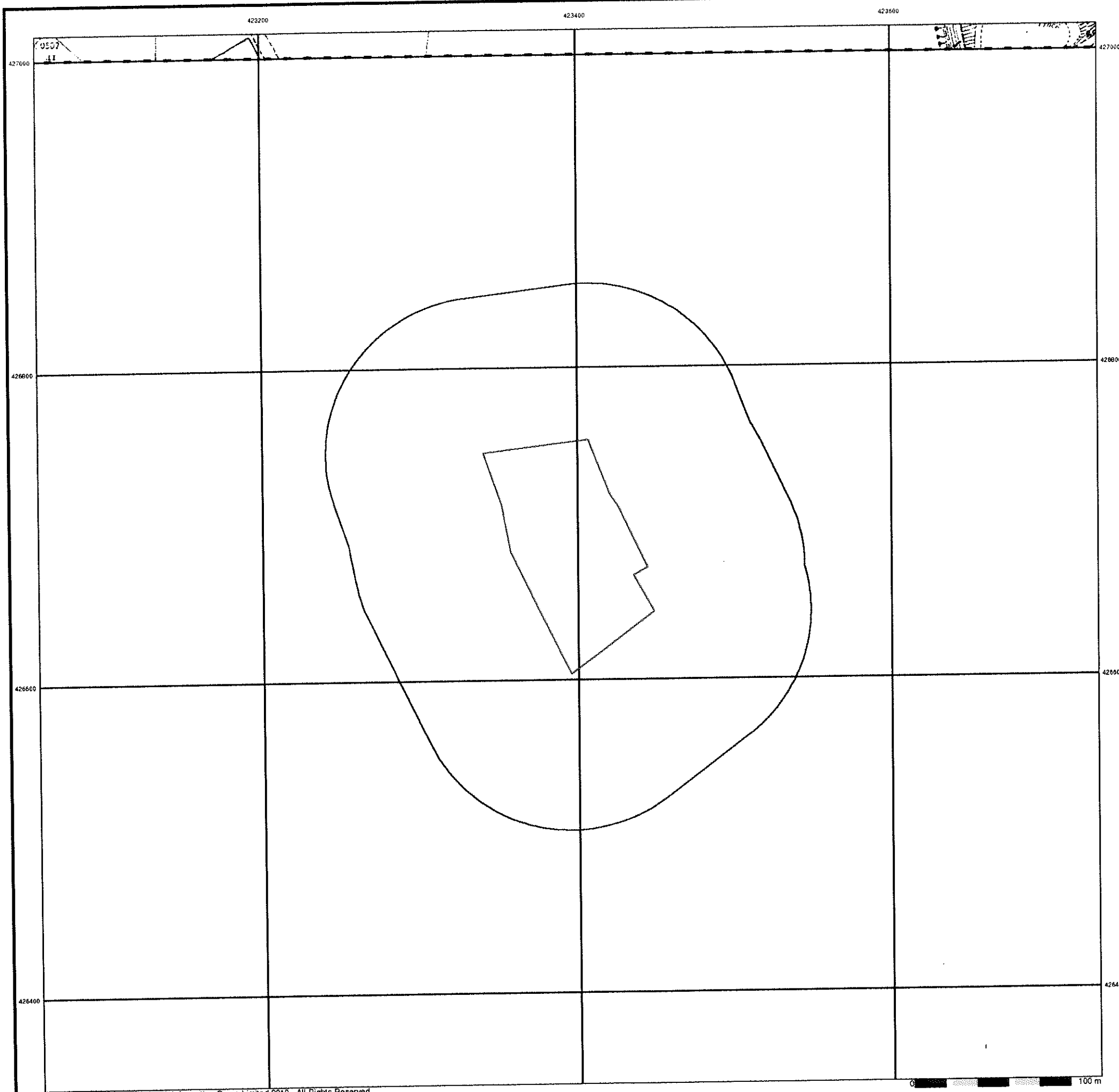

Envirocheck

LANDMARK INFORMATION GROUP

Supply of Unpublished Survey Information

Published 1974

Source map scale - 1:2,500

SUSI maps (Supply of Unpublished Survey Information) were produced between 1972 and 1977, mainly for internal use at Ordnance Survey. These were more of a 'work-in-progress' plan as they showed updates of individual areas on a map. These maps were unpublished, and they do not represent a single moment in time. They were produced at both 1:2,500 and 1:1,250 scales.

Map Name(s) and Date(s)

SE2327
1974
1:2,500

Historical Map - Segment A13

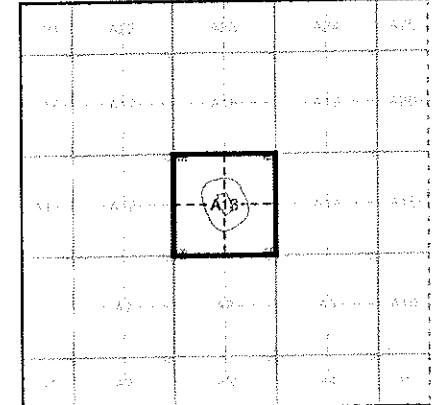

Order Details

Order Number: 226382729_1_1
 Customer Ref: 44688
 National Grid Reference: 423390, 426680
 Slice: A
 Site Area (Ha): 0.93
 Search Buffer (m): 100

Site Details

Site at 423390, 426690

Landmark
LANDMARK INFORMATION GROUP

Tel: 0844 844 9952
 Fax: 0844 844 9951
 Web: www.envirocheck.co.uk

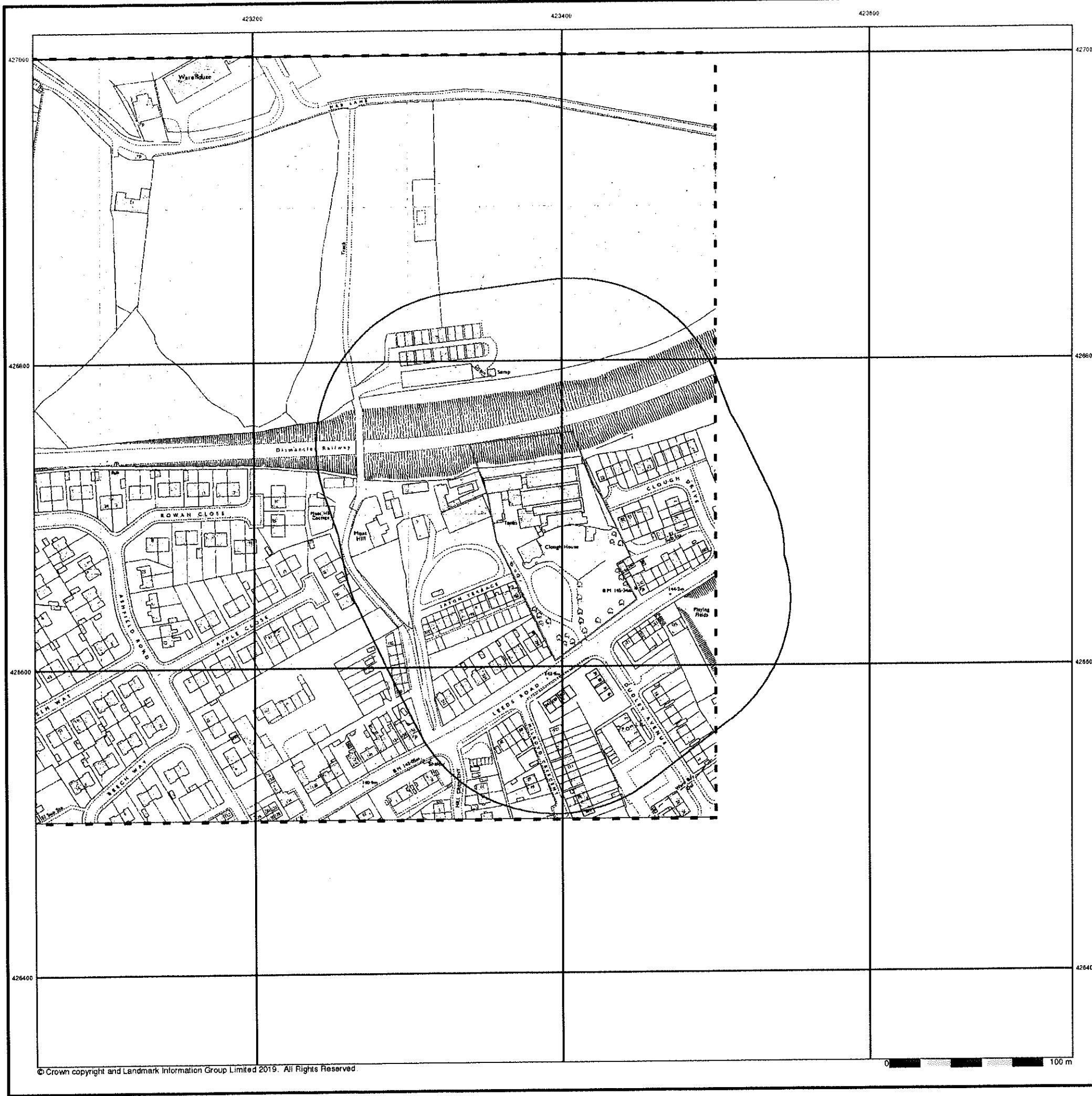

Supply of Unpublished Survey Information

Published 1974

Source map scale - 1:1,250

SUSI maps (Supply of Unpublished Survey Information) were produced between 1972 and 1977, mainly for internal use at Ordnance Survey. These were more of a 'work-in-progress' plan as they showed updates of individual areas on a map. These maps were unpublished, and they do not represent a single moment in time. They were produced at both 1:2,500 and 1:1,250 scales.

Map Name(s) and Date(s)

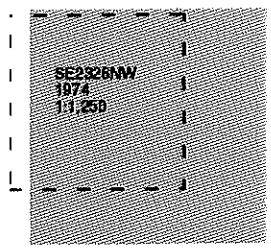

Historical Map - Segment A13

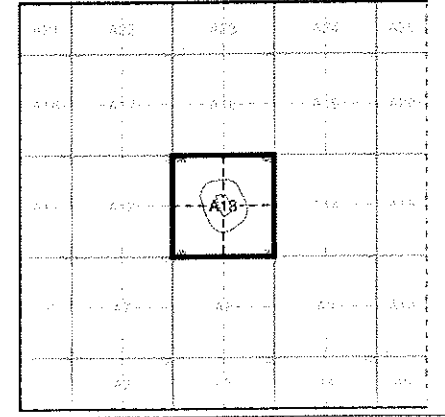

Order Details

Order Number: 226382729_1_1
 Customer Ref: 44688
 National Grid Reference: 423390, 426680
 Slice: A
 Site Area (Ha): 0.93
 Search Buffer (m): 100

Site Details

Site at 423390, 426690



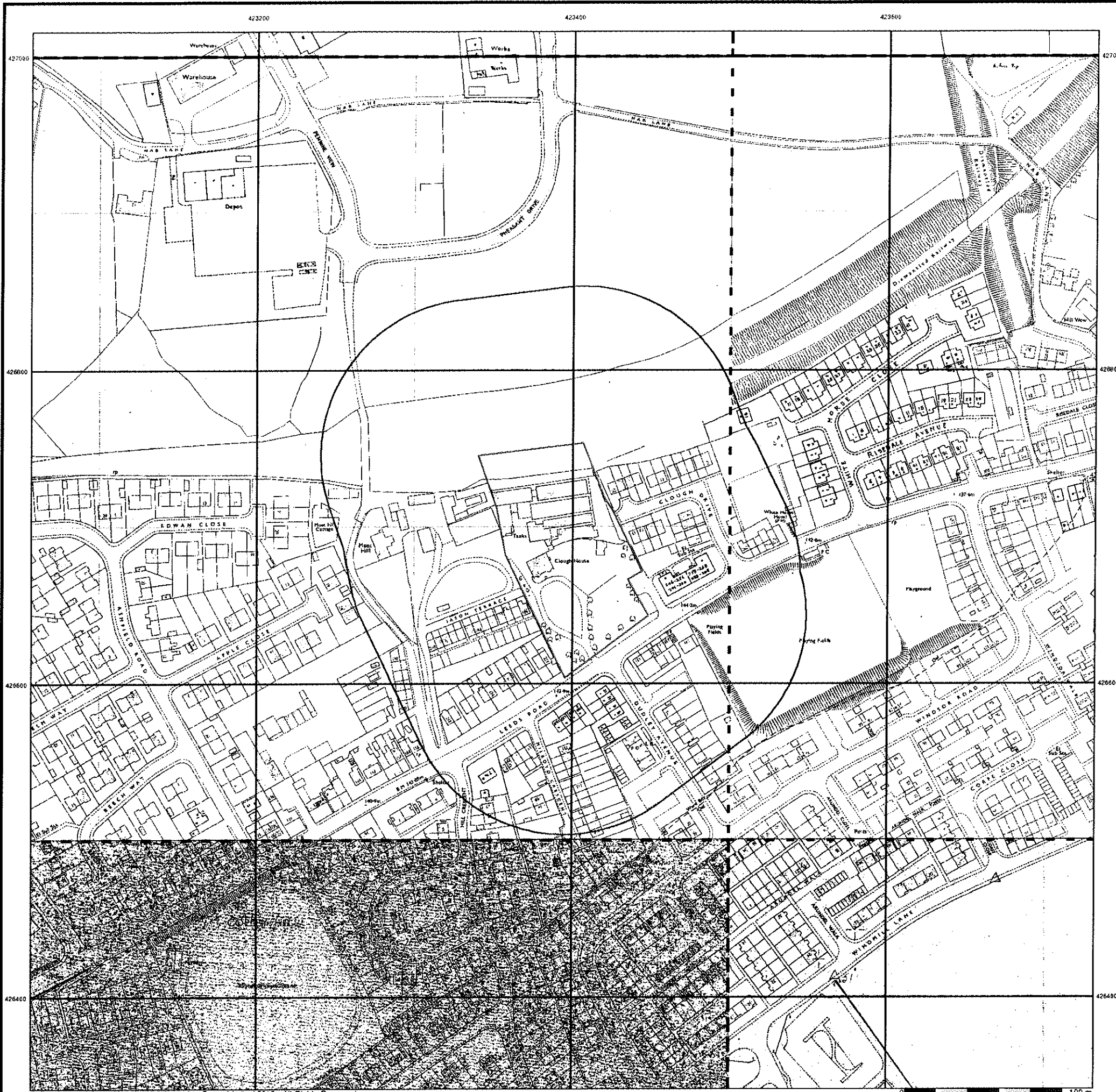

Envirocheck

LANDMARK INFORMATION GROUP

Additional SIMs

Published 1977 - 1992

Source map scale - 1:1,250

The SIM cards (Ordnance Survey's 'Survey of Information on Microfilm') are further, minor editions of mapping which were produced and published in between the main editions as an area was updated. They date from 1947 to 1994, and contain detailed information on buildings, roads and land-use. These maps were produced at both 1:2,500 and 1:1,250 scales.

Map Name(s) and Date(s)

IE2327SWSE2327SE	1987	1992
	1:1,250	1:1,250
IE2326NWSE2326NE	1985	1978
	1:1,250	1:1,250
IE2326SWSE2326SE	1977	1977
	1:1,250	1:1,250

Historical Map - Segment A13

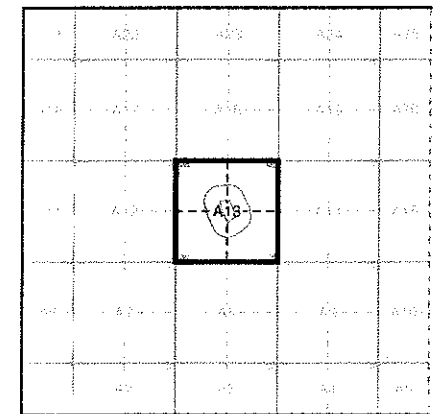

Order Details

Order Number: 226382729_1_1
 Customer Ref: 44688
 National Grid Reference: 423390, 426680
 Slice: A
 Site Area (Ha): 0.93
 Search Buffer (m): 100

Site Details

Site at 423390, 426690

Landmark
 LANDMARK INFORMATION GROUP

Tel: 0844 844 9952
 Fax: 0844 844 9951
 Web: www.envirocheck.co.uk

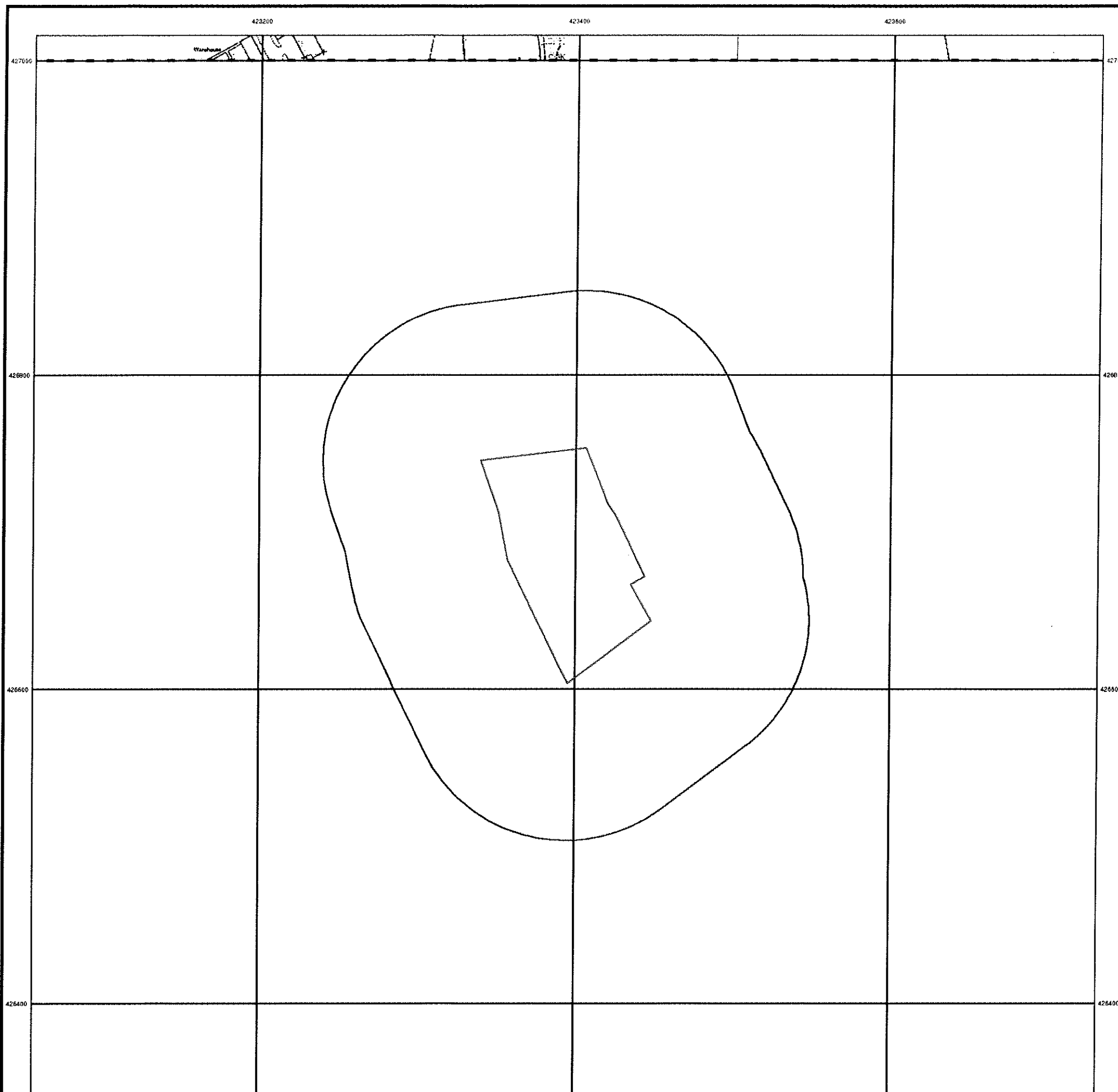

Envirocheck®

LANDMARK INFORMATION GROUP

Additional SIMs

Published 1987

Source map scale - 1:2,500

The SIM cards (Ordnance Survey's 'Survey of Information on Microfilm') are further, minor editions of mapping which were produced and published in between the main editions as an area was updated. They date from 1947 to 1994, and contain detailed information on buildings, roads and land-use. These maps were produced at both 1:2,500 and 1:1,250 scales.

Map Name(s) and Date(s)

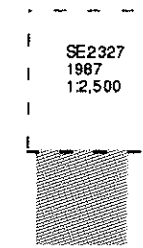

Historical Map - Segment A13

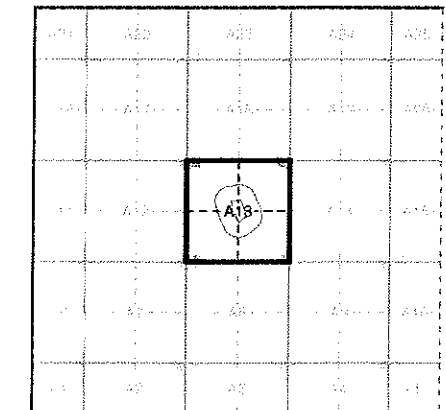

Order Details

Order Number: 226382729_1_1
 Customer Ref: 44688
 National Grid Reference: 423390, 426680
 Slice: A
 Site Area (Ha): 0.93
 Search Buffer (m): 100

Site Details

Site at 423390, 426690

Landmark
 LANDMARK INFORMATION GROUP

Tel: 0844 844 9952
 Fax: 0844 844 9951
 Web: www.envirocheck.co.uk

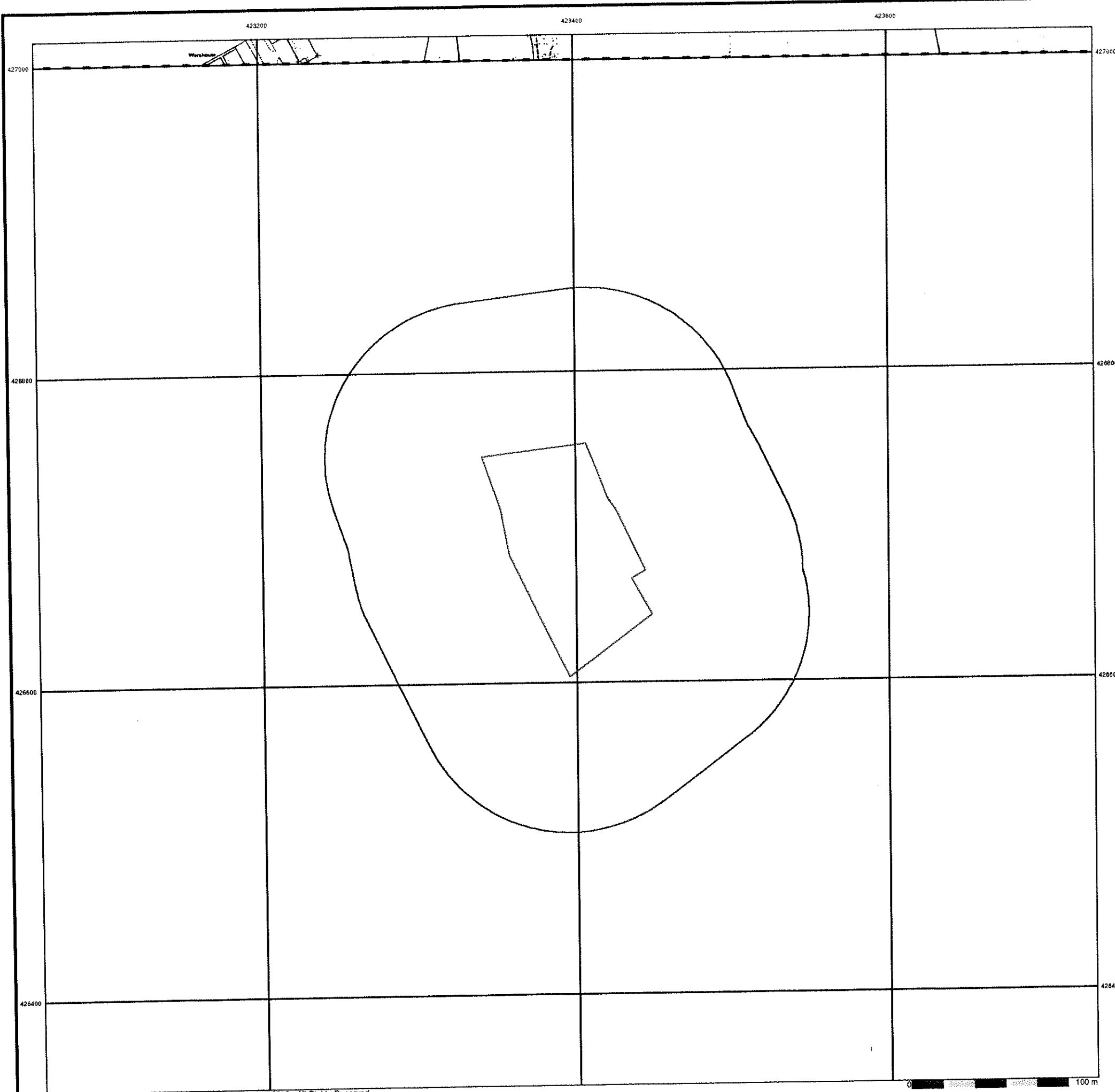

Additional SIMs
Published 1988
Source map scale - 1:2,500

The SIM cards (Ordnance Survey's 'Survey of Information on Microfilm') are further, minor editions of mapping which were produced and published in between the main editions as an area was updated. They date from 1947 to 1994, and contain detailed information on buildings, roads and land-use. These maps were produced at both 1:2,500 and 1:1,250 scales.

Map Name(s) and Date(s)

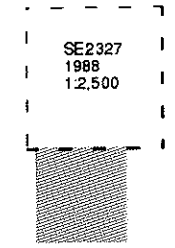

Historical Map - Segment A13

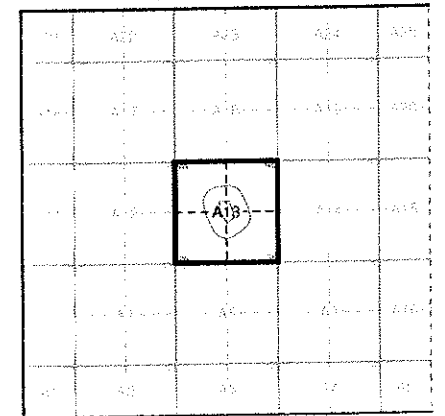

Order Details

Order Number: 226382729_1_1
 Customer Ref: 44688
 National Grid Reference: 423390, 426680
 Slice: A
 Site Area (Ha): 0.93
 Search Buffer (m): 100

Site Details

Site at 423390, 426690

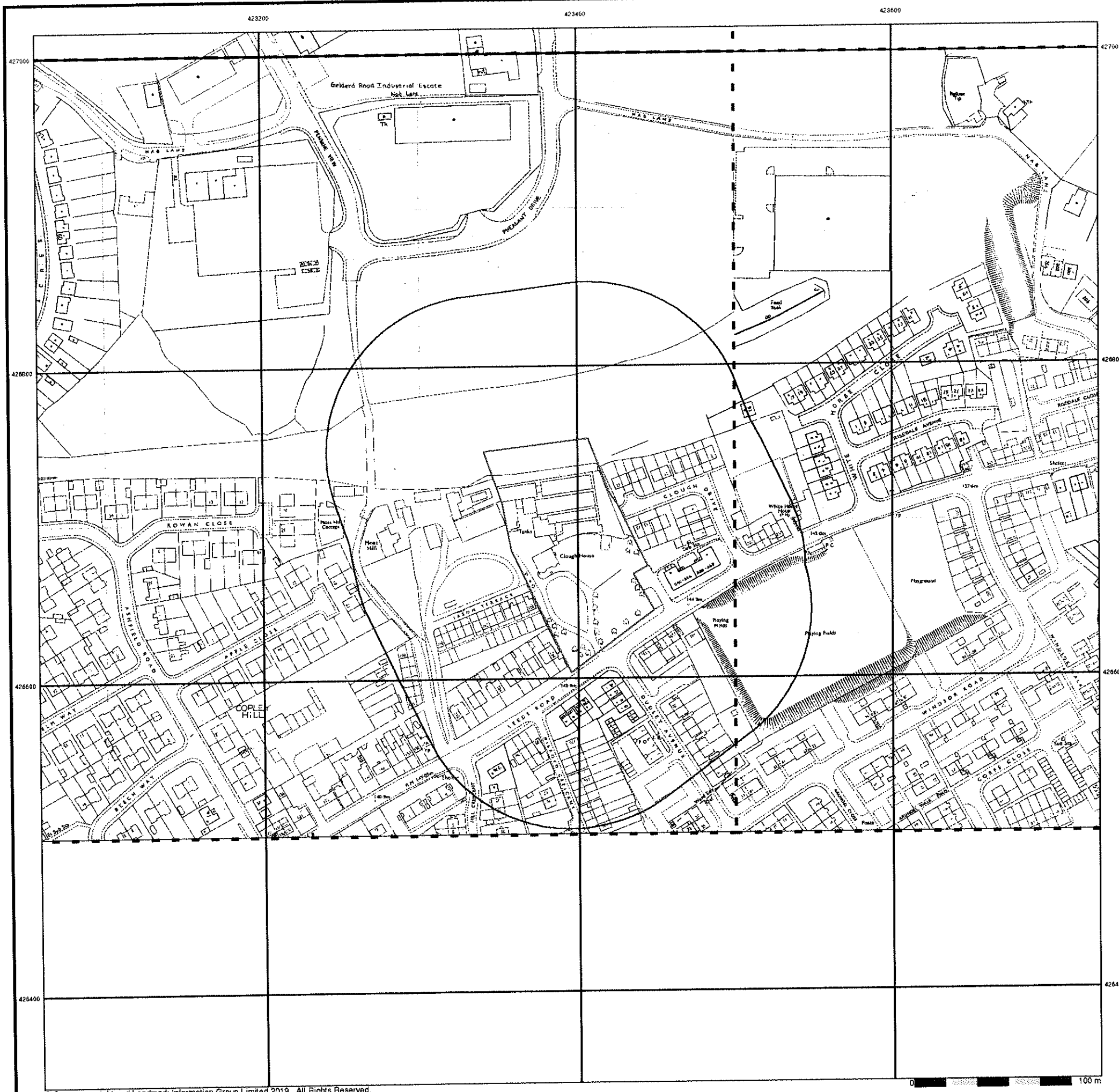

Additional SIMs

Published 1988 - 1990

Source map scale - 1:1,250

The SIM cards (Ordnance Survey's 'Survey of Information on Microfilm') are further, minor editions of mapping which were produced and published in between the main editions as an area was updated. They date from 1947 to 1994, and contain detailed information on buildings, roads and land-use. These maps were produced at both 1:2,500 and 1:1,250 scales.

Map Name(s) and Date(s)

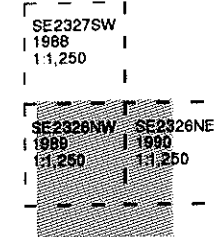

Historical Map - Segment A13

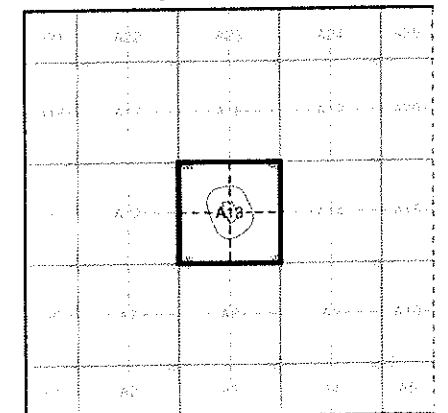

Order Details

Order Number: 226382729_1_1
 Customer Ref: 44688
 National Grid Reference: 423390, 426680
 Slice: A
 Site Area (Ha): 0.93
 Search Buffer (m): 100

Site Details

Site at 423390, 426690



Envirocheck®

LANDMARK INFORMATION GROUP

Additional SIMs

Published 1990 - 1991

Source map scale - 1:1,250

The SIM cards (Ordnance Survey's 'Survey of Information on Microfilm') are further, minor editions of mapping which were produced and published in between the main editions as an area was updated. They date from 1947 to 1994, and contain detailed information on buildings, roads and land-use. These maps were produced at both 1:2,500 and 1:1,250 scales.

Map Name(s) and Date(s)

SE2327SW
1991
1:1,250

SE2326NW
1990
1:1,250

Historical Map - Segment A13

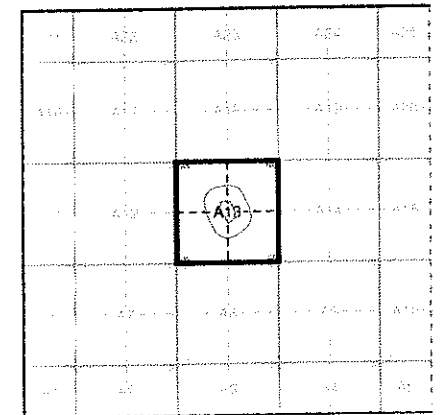

Order Details

Order Number: 226382729_1_1
 Customer Ref: 44688
 National Grid Reference: 423390, 426680
 Slice: A
 Site Area (Ha): 0.93
 Search Buffer (m): 100

Site Details

Site at 423390, 426690

Landmark
 LANDMARK INFORMATION GROUP

Tel: 0844 844 9952
 Fax: 0844 844 9951
 Web: www.envirocheck.co.uk

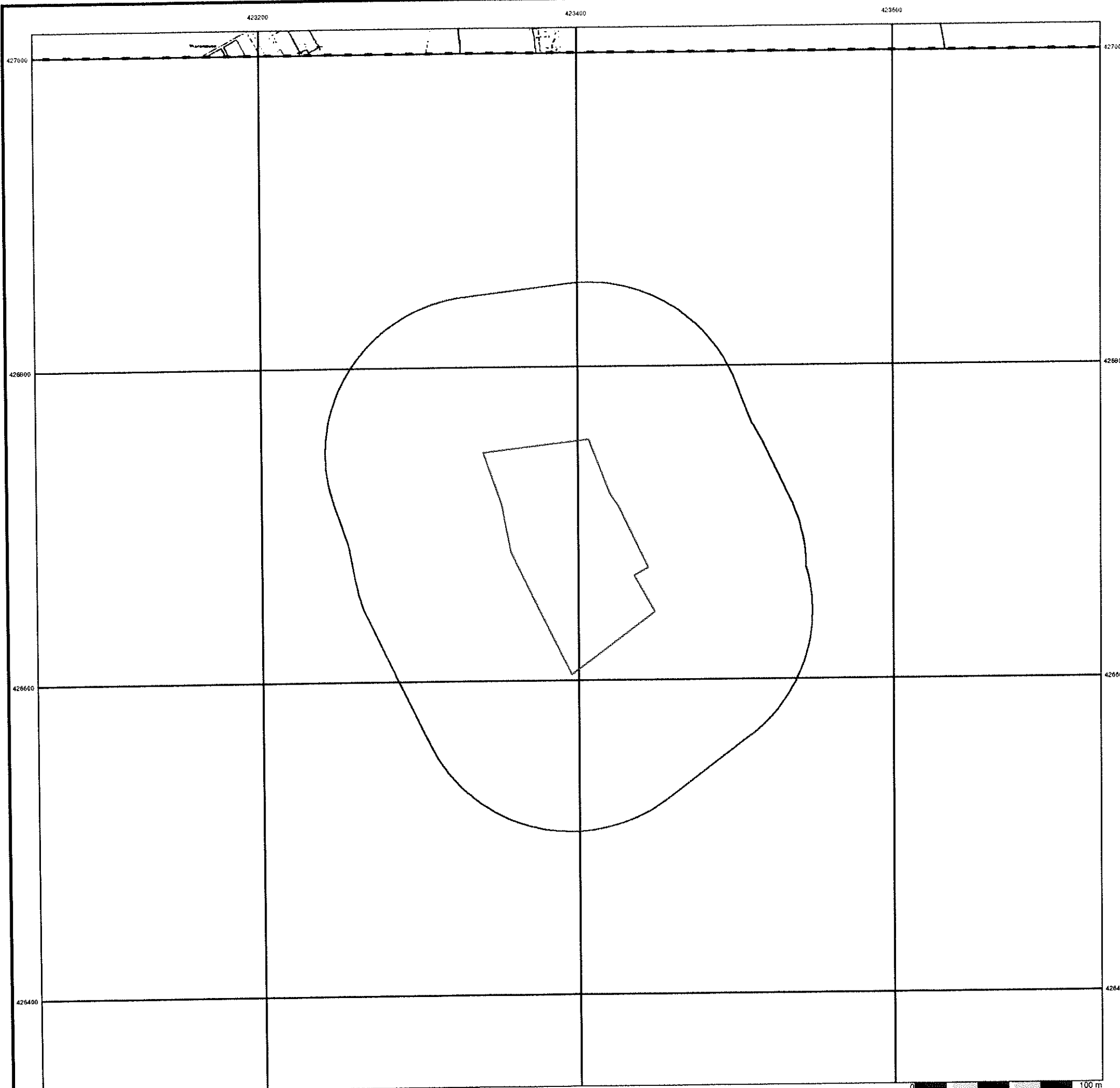

Additional SIMs
Published 1990
Source map scale - 1:2,500

The SIM cards (Ordnance Survey's 'Survey of Information on Microfilm') are further, minor editions of mapping which were produced and published in between the main editions as an area was updated. They date from 1947 to 1994, and contain detailed information on buildings, roads and land-use. These maps were produced at both 1:2,500 and 1:1,250 scales.

Map Name(s) and Date(s)

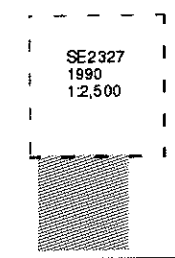

Historical Map - Segment A13

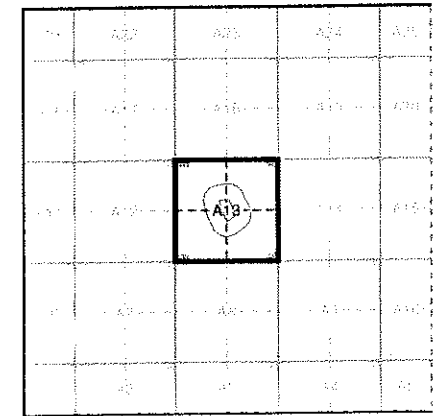

Order Details

Order Number: 226382729_1_1
 Customer Ref: 44688
 National Grid Reference: 423390, 426680
 Slice: A
 Site Area (Ha): 0.93
 Search Buffer (m): 100

Site Details

Site at 423390, 426690

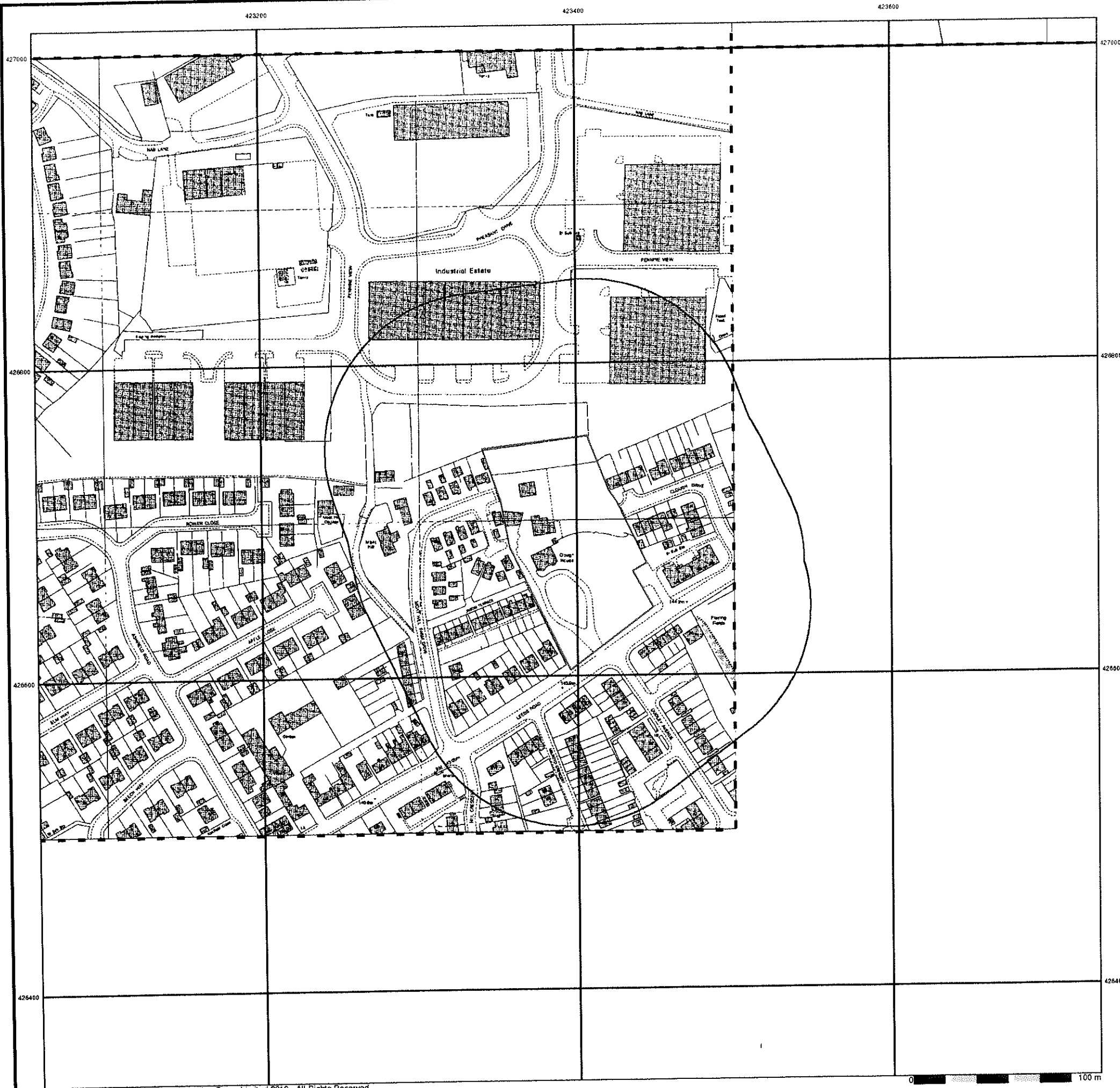

Envirocheck

LANDMARK INFORMATION GROUP

Ordnance Survey Plan
Published 1991 - 1992
Source map scale - 1:1,250

The historical maps shown were reproduced from maps predominantly held at the scale adopted for England, Wales and Scotland in the 1840's. In 1854 the 1:2,500 scale was adopted for mapping urban areas and by 1896 it covered the whole of what were considered to be the cultivated parts of Great Britain. The published date given below is often some years later than the surveyed date. Before 1938, all OS maps were based on the Cassini Projection, with independent surveys of a single county or group of counties, giving rise to significant inaccuracies in outlying areas.

Map Name(s) and Date(s)

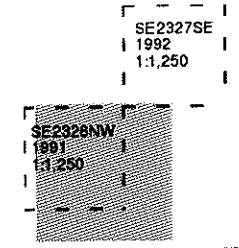

Historical Map - Segment A13

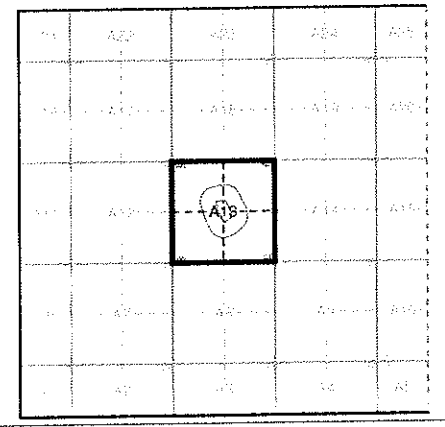

Order Details

Order Number: 226382729_1_1
 Customer Ref: 44688
 National Grid Reference: 423390, 426680
 Slice: A
 Site Area (Ha): 0.93
 Search Buffer (m): 100

Site Details

Site at 423390, 426690

Landmark
 LANDMARK INFORMATION GROUP

Tel: 0844 844 9952
 Fax: 0844 844 9951
 Web: www.envirocheck.co.uk





Envirocheck

LANDMARK INFORMATION GROUP

**Large-Scale National Grid Data
Published 1993**

Source map scale - 1:1,250

'Large Scale National Grid Data' superseded SIM cards (Ordnance Survey's 'Survey of Information on Microfilm') in 1992, and continued to be produced until 1999. These maps were the fore-runners of digital mapping and so provide detailed information on houses and roads, but tend to show less topographic features such as vegetation. These maps were produced at both 1:2,500 and 1:1,250 scales.

Map Name(s) and Date(s)

NE2327SWSE2327SE	1993	1:1,250
NE2326NWSE2326NE	1993	1:1,250
NE2326SWSE2326SE	1993	1:1,250

Historical Map - Segment A13

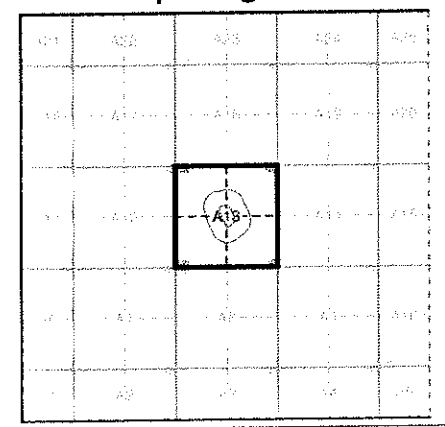

Order Details

Order Number:	226382729_1_1
Customer Ref:	44688
National Grid Reference:	423390, 426680
Slice:	A
Site Area (Ha):	0.93
Search Buffer (m):	100

Site Details

Site at 423390, 426690

Landmark
LANDMARK INFORMATION GROUP

Tel: 0844 844 9952
Fax: 0844 844 9951
Web: www.envirocheck.co.uk

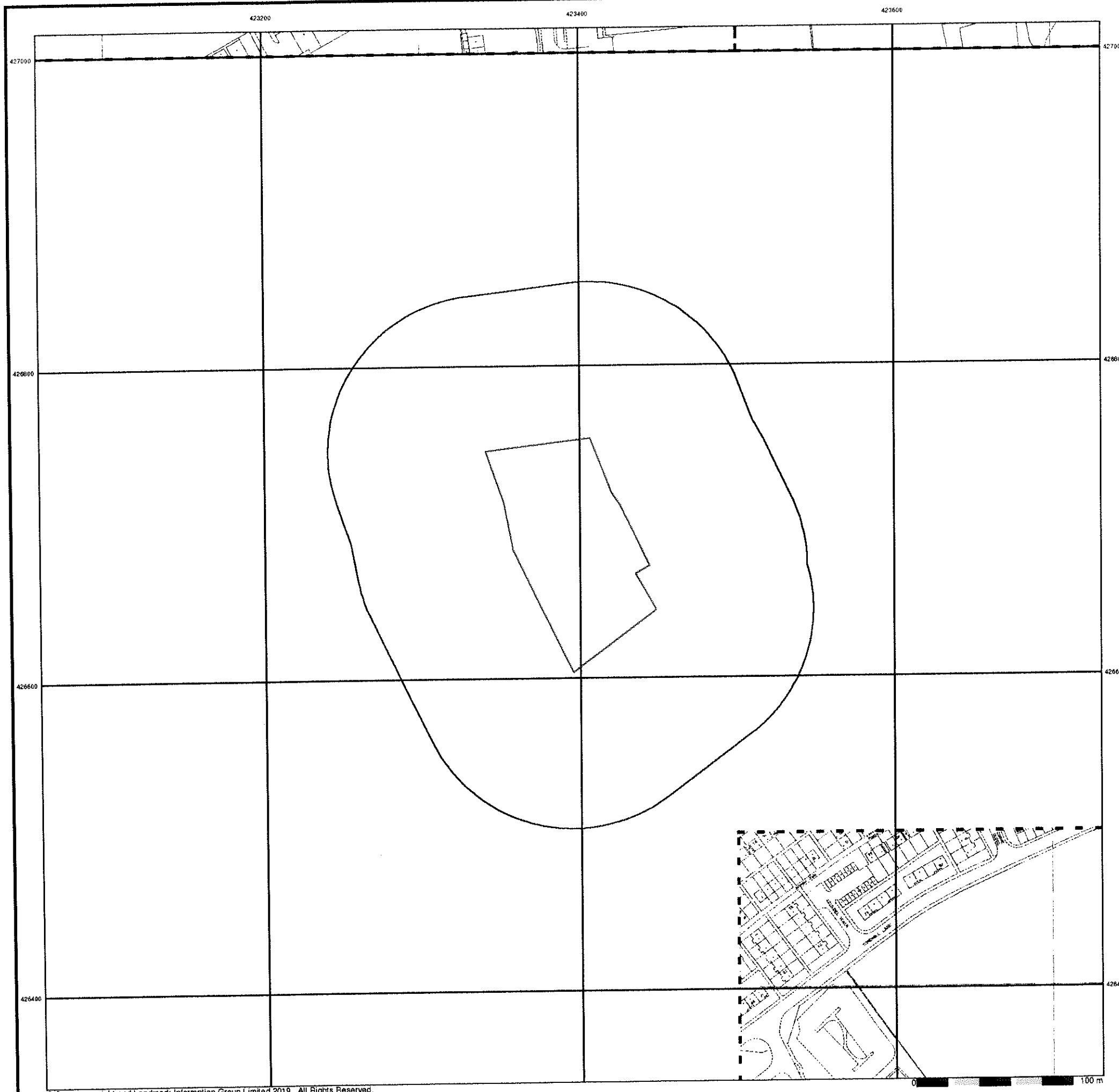

Envirocheck

LANDMARK INFORMATION GROUP

Large-Scale National Grid Data Published 1994 - 1995

Source map scale - 1:1,250

'Large Scale National Grid Data' superseded SIM cards (Ordnance Survey's 'Survey of Information on Microfilm') in 1992, and continued to be produced until 1999. These maps were the fore-runners of digital mapping and so provide detailed information on houses and roads, but tend to show less topographic features such as vegetation. These maps were produced at both 1:2,500 and 1:1,250 scales.

Map Name(s) and Date(s)

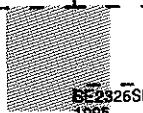
IE2327SW	IE2327SE
1994	1994
1:1,250	1:1,250
	
EE2326SE	
1995	
1:1,250	

Historical Map - Segment A13

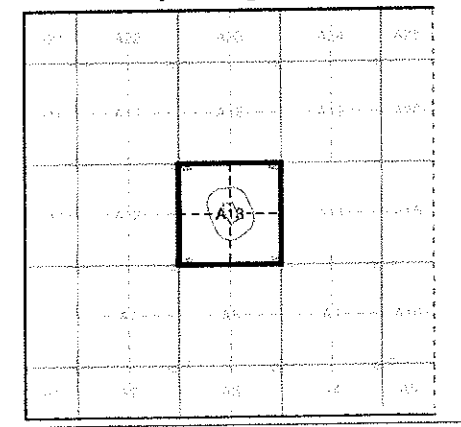

Order Details

Order Number: 226382729_1_1
 Customer Ref: 44688
 National Grid Reference: 423390, 426680
 Slice: A
 Site Area (Ha): 0.93
 Search Buffer (m): 100

Site Details

Site at 423390, 426690

Landmark
 LANDMARK INFORMATION GROUP

Tel: 0844 844 9952
 Fax: 0844 844 9951
 Web: www.envirocheck.co.uk



Historical Aerial Photography Published 1999

This aerial photography was produced by Getmapping, these vertical aerial photographs provide a seamless, full colour survey of the whole of Great Britain

Historical Aerial Photography - Segment A13

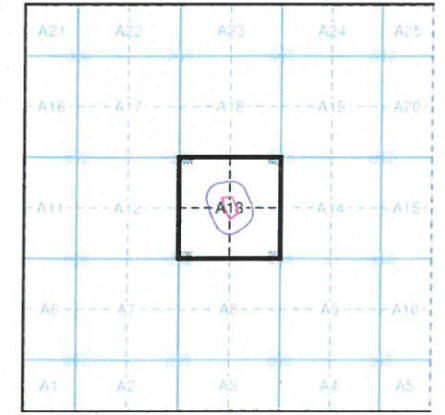

Order Details

Order Number: 226382729_1_1
 Customer Ref: 44688
 National Grid Reference: 423390, 426680
 Slice: A
 Site Area (Ha): 0.93
 Search Buffer (m): 100

Site Details

Site at 423390, 426690