

## Wavin Limited

Edlington Lane  
Edlington  
Doncaster  
South Yorkshire DN12 1BY  
Tel: 01709 856300 Fax: 01709 856301  
e-mail: info@wavin.co.uk  
website: www.wavin.com



Agrément Certificate  
**03/4018**  
Product Sheet 1

## WAVIN AQUACELL ATTENUATION AND INFILTRATION SYSTEMS

### AQUACELL CORE

This Agrément Certificate Product Sheet<sup>(1)</sup> relates to AquaCell Core, comprising blue polypropylene modular units for use either as below-ground storage tanks or as a soakaway to manage run-off from impermeable surfaces.

(1) Hereinafter referred to as 'Certificate'.

#### CERTIFICATION INCLUDES:

- factors relating to compliance with Building Regulations where applicable
- factors relating to additional non-regulatory information where applicable
- independently verified technical specification
- assessment criteria and technical investigations
- design considerations
- installation guidance
- regular surveillance of production
- formal three-yearly review.



#### KEY FACTORS ASSESSED

**Hydraulic design** — data is provided in this Certificate to assist in the design of a below-ground water management system incorporating AquaCell Core (see section 6).

**Structural design** — the system has adequate strength and stiffness to resist short- and long-term loading when designed in accordance with this Certificate (see section 7).

**Maintenance** — data is provided in this Certificate to assist in planning the maintenance of a completed system (see section 11).

**Durability** — the system will have a service life in excess of 50 years when installed in accordance with this Certificate (see section 12).

The BBA has awarded this Certificate to the company named above for the system described herein. This system has been assessed by the BBA as being fit for its intended use provided it is installed, used and maintained as set out in this Certificate.

On behalf of the British Board of Agrément

Brian Chamberlain  
Head of Technical Excellence

Claire Curtis-Thomas  
Chief Executive

Date of Second issue: 2 November 2016

Originally certificated on 28 March 2003

*The BBA is a UKAS accredited certification body — Number 113. The schedule of the current scope of accreditation for product certification is available in pdf format via the UKAS link on the BBA website at [www.bbacerts.co.uk](http://www.bbacerts.co.uk)*

*Readers are advised to check the validity and latest issue number of this Agrément Certificate by either referring to the BBA website or contacting the BBA direct.*

British Board of Agrément  
Bucknalls Lane  
Watford  
Herts WD25 9BA

©2016

tel: 01923 665300  
fax: 01923 665301  
[clientservices@bba.star.co.uk](mailto:clientservices@bba.star.co.uk)  
[www.bbacerts.co.uk](http://www.bbacerts.co.uk)

# Regulations

In the opinion of the BBA, AquaCell Core, if installed, used and maintained in accordance with this Certificate, can satisfy or contribute to satisfying the relevant requirements of the following Building Regulations (the presence of a UK map indicates that the subject is related to the Building Regulations in the region or regions of the UK depicted):



## The Building Regulations 2010 (England and Wales) (as amended)

Requirement:	H3(3)	Rainwater drainage
Comment:		The system can be used in a construction to meet this Requirement. See section 6 of this Certificate.
Regulation:	7	Materials and workmanship
Comment:		The system components are acceptable. See section 12 and the <i>Installation</i> part of this Certificate.



## The Building (Scotland) Regulations 2004 (as amended)

Regulation:	8(1)(2)	Durability, workmanship and fitness of materials
Comment:		The system can contribute to satisfying this Regulation. See sections 11 and 12 and the <i>Installation</i> part of this Certificate.
Regulation:	9	Building standards applicable to construction
Standard:	3.6	Surface water drainage
Comment:		The system can contribute to a construction satisfying this Standard, with reference to clauses 3.6.1 <sup>(1)(2)</sup> to 3.6.5 <sup>(1)(2)</sup> . See section 6 of this Certificate.
Standard:	7.1(a)(b)	Statement of sustainability
Comment:		The system can contribute to meeting the relevant requirements of Regulation 9, Standards 1 to 6 and therefore will contribute to a construction meeting a bronze level of sustainability as defined in this Standard.
Regulation:	12	Building standards applicable to conversions
Comment:		All comments in relation to the system under Regulation 9, Standards 1 to 6 also apply to this Regulation, with reference to clause 0.12.1 <sup>(1)(2)</sup> and Schedule 6 <sup>(1)(2)</sup> . (1) Technical Handbook (Domestic). (2) Technical Handbook (Non-Domestic).



## The Building Regulations (Northern Ireland) 2012 (as amended)

Regulation:	23(a)(i)(iii)(b)	Fitness of materials and workmanship
Comment:		The system is acceptable. See section 12 and the <i>Installation</i> part of this Certificate.
Regulation:	82	Rainwater drainage
Comment:		The system can be used in a construction to satisfy this Regulation. See section 6 of this Certificate.

### Construction (Design and Management) Regulations 2015

### Construction (Design and Management) Regulations (Northern Ireland) 2016

Information in this Certificate may assist the client, designer (including Principal Designer) and contractor (including Principal Contractor) to address their obligations under these Regulations.

See sections: 1 *Description* (1.2), 3 *Delivery and site handling* (3.1) and 15 *Procedure* (15.1) of this Certificate.

# Technical Specification

## 1 Description

1.1 AquaCell Core consists of individual blue polypropylene modular units, polypropylene shear connectors to hold units together vertically, and polypropylene clips to hold units together horizontally (see Figure 1).

Figure 1 System components

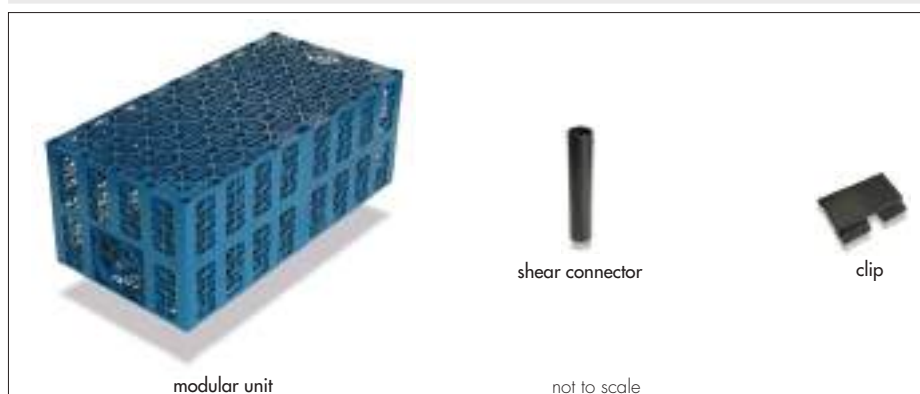

1.2 The overall unit dimensions and characteristics of AquaCell Core are shown in Table 1.

*Table 1 Characteristics of modular units*

Characteristic (unit)	Value
Unit dimensions (nominal) (mm) (L x W x H)	1000 x 500 x 400
Unit volume (nominal) (m <sup>3</sup> )	0.20
Storage volume (nominal) (m <sup>3</sup> )	0.19
Void ratio (%)	95
Unit weight (nominal) (kg)	9.6

1.3 The polypropylene modular units have preformed sockets to enable connection to 160 mm diameter pipework. Alternatively, connection to 150 mm pipework is possible using an adaptor. Connection can also be made, at points other than the preformed sockets, to suitable 150 mm or 225 mm pipework using a flange adaptor. Adaptors and connecting pipework for use with the system are outside the scope of this Certificate.

1.4 Ancillary items necessary for use with the system (according to best practice), but outside the scope of this Certificate, are:

- adaptors and connecting pipework
- air vents
- inspection points
- inspection chamber modules
- silt traps and sediment separators
- permeable geotextile — wrapped around each assembly when used for infiltration
- geomembrane — wrapped around each assembly when used for storage (attenuation)
- protective fleece — wrapped around each assembly when used for storage (attenuation), to give added protection to the geomembrane
- granular material/coarse sand.

## **2 Manufacture**

2.1 The system components are injection-moulded using polypropylene to one specification.

2.2 As part of the assessment and ongoing surveillance of product quality, the BBA has:

- agreed with the manufacturer the quality control procedures and product testing to be undertaken
- assessed and agreed the quality control operated over batches of incoming materials
- monitored the production process and verified that it is in accordance with the documented process
- evaluated the process for management of nonconformities
- checked that equipment has been properly tested and calibrated
- undertaken to carry out the above measures on a regular basis through a surveillance process, to verify that the specifications and quality control operated by the manufacturer are being maintained.

2.3 The management system of Wavin UK (Holdings) Ltd has been assessed and registered as meeting the requirements of BS EN ISO 9001 : 2008 by SGS UK Ltd (Certificate GB08/74586).

## **3 Delivery and site handling**

3.1 The system is supplied to site in packs of 12 or 15 units, secured with straps, with plastic feet attached to the underside to enable placing and movement by a fork-lift. Each pack of units carries a label bearing the system type, part number, operator's initials, individual pallet sequential number and date of manufacture.

3.2 Each unit is supplied with two shear connectors and three clips.

3.3 The packs should be carefully placed on level ground and should not be stacked on site. Loose individual units should not be stored more than two units high.

3.4 The units contain an inhibitor to resist the effects of ultraviolet light for up to six months. However, prolonged exposure to direct sunlight should be avoided.

3.5 The units should not be stored near fuel bowsers, fuel tanks or other solvents, to avoid potential chemical damage.

3.6 The units are resistant to damage that could occur with normal handling. They should be stored away from the possibility of impacts by vehicles and other construction plant.

# Assessment and Technical Investigations

The following is a summary of the assessment and technical investigations carried out on AquaCell Core.

## Design Considerations

### 4 General

4.1 The design of AquaCell Core must be in accordance with the Certificate holder's design guidelines. Guidance on the application of sustainable drainage systems (SUDS) for new developments can be found in The National Planning Policy Framework, and *The SUDS Manual (C697)* published by the Construction Industry Research and Information Association (CIRIA).

4.2 The system is satisfactory for the management of stormwater run-off from impermeable surfaces and can be used in three main ways (see Figure 2):

- infiltration — water is stored within the system during rainfall, and allowed to drain away by soaking into the surrounding ground over a period of time after the rain has ceased
- attenuation — water is stored within the system during rainfall and released at a reduced flow rate through a flow control device into an appropriate outfall. This reduces peak flows in the watercourse, thereby minimising the risk of flooding
- a combination of infiltration and attenuation.

Figure 2 Sustainable drainage system selection and design

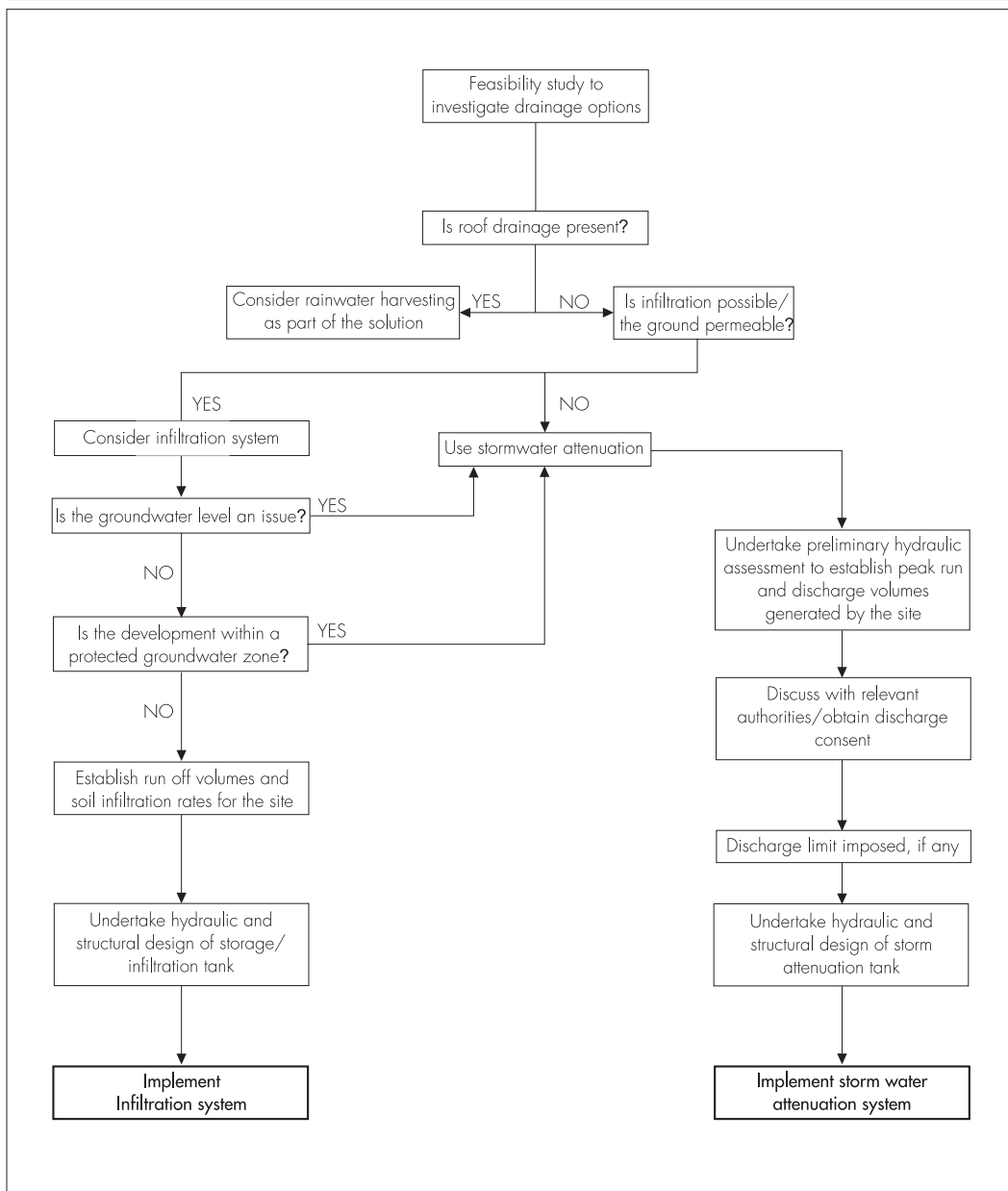

4.3 The design of a system for a specific project must always be preceded by a detailed audit of the proposed site to establish:

- existing factors and considerations applicable to the site
- predicted factors relating to the site's use following the planned development, and the parameters within which the installation is required to function
- the type of function of application suggested by this audit.

4.4 Once the project criteria have been established from the site audit, there are two main parts to the design procedure of individual installations: hydraulic design and structural design.

## 5 Practicability of installation

The system is designed to be installed by a competent general builder or contractor with experience of this type of system.

## 6 Hydraulic design

### Infiltration

#### Calculation principles

6.1 There are two approaches, either of which can be adopted: CIRIA Report 156 *Infiltration drainage – Manual of good practice* and BRE Digest 365 *Soakaway design*. Further information on the design of SUDS may be obtained from *The SUDS Manual (C697)*.

6.2 A simplified approach can be used on a small site (ie a single-house development), where detailed site infiltration rate information may not be required or available (see Table 2). In Approved Document H, a storage volume equal to the area to be drained, multiplied by 10 mm, for areas up to 25 m<sup>2</sup> is allowed. Beyond this size, design should be carried out in accordance with BS EN 752 : 2008 or BRE Digest 365. BS EN 752 : 2008 suggests a storage volume equal to 20 mm multiplied by the area to be drained. In Scotland, guidance for the design of single-house soakaways is given in Mandatory Standard 3.6, clause 3.6.5<sup>(1)</sup>.

(1) Technical Handbook (Domestic).

Table 2 Simplified soakaway design for single-house development<sup>(1)</sup>

Number of units	Storage volume (m <sup>3</sup> )	Maximum area to be drained (m <sup>2</sup> )
1	0.19	19 <sup>(2)</sup>
2	0.38	25 <sup>(2)</sup>
3	0.57	28.5 <sup>(3)</sup>
4	0.76	38 <sup>(3)</sup>
5	0.95	47.5 <sup>(3)</sup>
6	1.14	57 <sup>(3)</sup>

(1) When doubt exists over suitability of ground for infiltration permeability, figures should be derived by test (see BRE Digest 365).

(2) In accordance with Approved Document H.

(3) In accordance with BS EN 752 : 2008, clause NA 4.4.8.

6.3 When the BRE or CIRIA approach is used, the design volumes and areas for trench or cuboid type installations can be found in Tables 3 and 4 of this Certificate.

Table 3 Data for use in hydraulic design – one unit wide trench configuration

Number of units high	System volume (m <sup>3</sup> ) per metre length of trench	Vertical surface area (m <sup>2</sup> ) (both sides) per metre length of the system	Area beneath system (m <sup>2</sup> ) per metre length of trench
1	0.19	0.8	0.5
2	0.38	1.6	0.5

Table 4 Data for use in hydraulic design — three-dimensional systems, two units high

System length (number of units long) (1.2 m side)	2 units wide (0.5 m side)			4 units wide (0.5 m side)			8 units wide (0.5 m side)		
	Volume (m <sup>3</sup> )	Area around sides and ends (m <sup>2</sup> )	Area under base (m <sup>2</sup> )	Volume (m <sup>3</sup> )	Area around sides and ends (m <sup>2</sup> )	Area under base (m <sup>2</sup> )	Volume (m <sup>3</sup> )	Area around sides and ends (m <sup>2</sup> )	Area under base (m <sup>2</sup> )
1	0.76	3.2	1.0	1.52	4.8	2.0	3.04	8.0	4.0
2	1.52	4.8	2.0	3.04	6.4	4.0	6.08	9.6	8.0
4	3.04	8.0	4.0	6.08	9.6	8.0	12.16	12.8	16.0
8	6.08	14.4	8.0	12.16	16.0	16.0	24.32	19.2	32.0
10	7.6	17.6	10.0	15.2	19.2	20.0	30.4	22.4	40.0
100	76.0	161.6	100.0	152.0	163.2	200.0	304.0	166.4	400.0

6.4 For calculations, the size and volume of the units are given in Table 1. The total areas of the base and sides are required as water is absorbed through the geotextile soil interface. Storage volume is 95% of the total volume. As an example, using Table 4, for a typical linear trench 40 m long and two units deep the volume is 0.38 by 40 = 15.2 m<sup>3</sup> and the side area 1.6 by 40 = 64 m<sup>2</sup>.

## Attenuation

### Calculation principles

6.5 The anticipated total run-off volume from the site is estimated. The most commonly-used method for evaluating storm rainfall events in the UK is the Wallingford Procedure, by which the total rainfall level of storms over defined time periods, ranging from five minutes up to 48 hours, is assessed. The allowable discharge rate from the site to an appropriate outfall is established, but will normally be set by the Environment Agency, Scottish Environmental Protection Agency or Planning Authorities. The volume to be stored underground in the system is then determined and the number of units needed to contain this volume is calculated on the basis that the storage volume is equal to 95% of the total volume of the system.

## Connections

6.6 Connection is made to the units using a preformed socket and adaptor, or a flange adaptor.

6.7 It is recommended that all connections into storage applications (using a geomembrane) are made using a flange adaptor. Adhesive or double-sided tape should be used between the geomembrane and flange adaptor to ensure a watertight seal.

## Manifold design

6.8 The units are manufactured to allow a connection to be formed by insertion of 160 mm diameter pipes to BS EN 13476-3 : 2007 into the knock-out incorporated in each cell. The capacity of a 160 mm pipe is limited and may be insufficient for the anticipated design flow. The flow may be split amongst a number of 160 mm pipes connected to a manifold to provide increased hydraulic capacity (see Figure 3). The system designer should ensure that the pipework connecting the units to the drainage system has sufficient capacity to cope with the design flow.

Figure 3 Typical inlet connection design

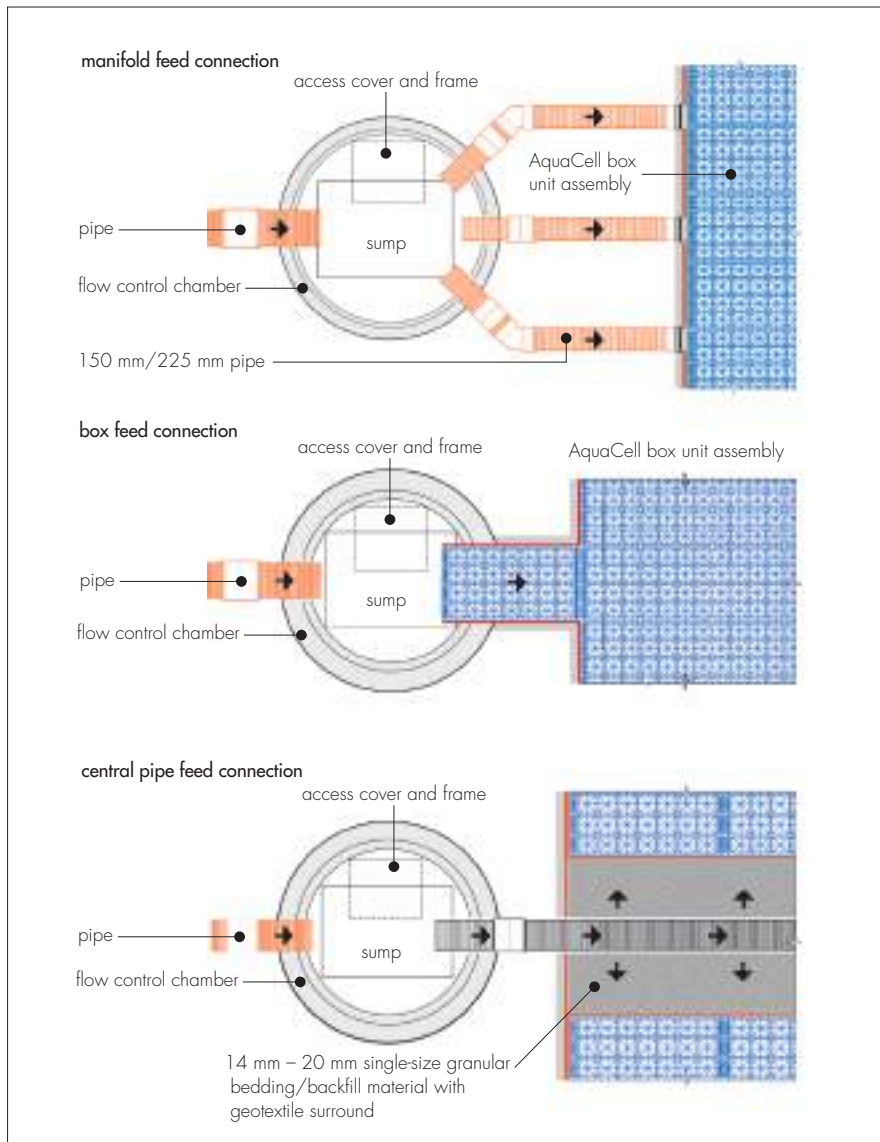

### Flow control

6.9 When the system is used for attenuation purposes, the outflow from the system must be controlled to comply with the discharge rate consent of the site. The main methods to achieve outflow control are orifice plate, vortex valve or small pipe. Comparative features and benefits of these various control flow devices should be considered prior to selection.

### Outflow positioning and head calculations

6.10 The invert level of the outflow pipe should be flush with the bottom of the lowest unit to allow the system to drain. As the system fills, a depth of water develops on the upstream side of the outflow control. For a system with two layers of units, this depth is 0.8 m when the units are full, creating a driving head to push the flow through the control device. For design purposes, the head used in calculations is taken as that at the invert line of the outflow device.

## 7 Structural design

7.1 The structural design of each installation incorporating the system should be carried out by a suitably-qualified and experienced engineer.

7.2 Guidance on the design and installation of systems incorporating the units can be found in CIRIA Report C680 *Structural design of modular geocellular drainage tanks*. Consideration should be given to the effects of cumulative deflection in systems comprising several layers of units.

7.3 The system can be placed under a wide variety of landscaped or lightly-trafficked areas. Design procedures for heavily-trafficked applications are outside the scope of this Certificate. The advice of the Certificate holder should be sought for areas subjected to high-volume traffic, commercial vehicles or other heavy loads.

7.4 Care should be taken when the system is used for infiltration below trafficked areas and close to structures. It is important to ensure that the infiltrating water will not soften the soils or cause loss of fines and settlement.

7.5 The engineer responsible for the design of the installation must confirm that the ground-bearing capacity at the formation level is sufficient for the proposed operational loads. In areas of weak or compressible soils, advice should be sought from a geotechnical engineer.

7.6 When the system is wrapped in an impermeable geomembrane and placed below the groundwater table, flotation may occur. To prevent this, the weight of the soil over the top of the units must be greater than the uplift force caused by the unit's buoyancy in the water. This can be achieved with most types of fill if the depth of cover fill is equal to, or greater than, the depth of penetration of the units below groundwater level.

### Performance characteristics

7.7 Characteristic compressive strength at the yield point and elastic deflection values for the system have been determined from independent short-term tests (see Table 5).

Performance characteristic (unit)	Value
Characteristic compressive strength at the yield point ( $\text{kN}\cdot\text{m}^{-2}$ )	
vertical loading on top face	627
lateral loading on side face	87
Short-term elastic deflection (mm per $\text{kN}\cdot\text{m}^{-2}$ ) (applied load)	
vertical loading on top face	1 per 79
lateral loading on side face	1 per 10

7.8 Creep tests indicate that the long-term vertical deflection may be estimated from the equations shown in Table 6. This is valid for loads up to  $141 \text{ kN}\cdot\text{m}^{-2}$  for durations of up to 20 years at  $20^\circ\text{C}$ . In locations where settlement is not a concern, designs of up to 50 years can be considered.

For loads up to ( $\text{kN}\cdot\text{m}^{-2}$ ):	Equations for estimation of long-term deflection (mm)
141	Vertical deflection = $0.4705 \ln [\text{time (days)}] + 4.0005$
21.81	Lateral deflection = $1.0130 \ln [\text{time (days)}] + 1.1509$

7.9 The partial load and material factors given in Table 7, as defined in CIRIA Report C680, should be used for design.

Description	Ultimate limit state	Serviceability limit state
Partial factors for loads		
vertical dead-load ( $F_{dl}$ )	1.40	1.00
earth pressure (horizontal) + hydrostatic (horizontal) load ( $F_{ep}$ )	1.35	1.00
imposed live-load ( $F_{ll}$ )	1.60	1.00
Partial safety factors for materials ( $F_m$ )	2.75	1.50

Note: Where applicable, additional factors should be considered for dynamic factor and material factors for creep/fatigue.

7.10 Example maximum installation depths and minimum depths of cover, calculated as described in this Certificate and in accordance with CIRIA Report C680, are shown in Tables 8, 9 and 10. For soakaways serving an individual house, the system is located below a garden a minimum of 5 m from the building, inaccessible to motor vehicles. Table 8 indicates the maximum installation depth and minimum depths of cover.

Criterion (unit)	Value
Maximum depth to base of units (m)	4.53
Minimum cover depth (m)	0.50

(1) The following assumptions apply:

- soakaway constructed in sandy gravels with a soil weight not exceeding  $20 \text{ kg}\cdot\text{m}^{-3}$  and angle of shearing resistance for surrounding soil not less than  $30^\circ$
- groundwater at least one metre below the base of the units
- soakaway located beneath small gardens or landscaped areas inaccessible to motor vehicles, in accordance with Table 4.2 of CIRIA Report C680.

7.11 For installations below landscaped and lightly-trafficked areas, the information given in Tables 9 and 10 is only applicable in temperate climate conditions, such as those in the UK. Site-specific calculations should be carried out for configurations and prevailing ground conditions other than those shown.

**Table 9 Maximum installation depths based on two layers of AquaCell Core units (to base of units)**

Soil description	Soil weight (kN·m <sup>-3</sup> )	Angle of internal friction (degrees)	No groundwater present		Groundwater present (1.0 m below ground level)	
			Car parks <sup>(1)</sup>	Landscaped areas <sup>(2)</sup>	Car parks <sup>(1)</sup>	Landscaped areas <sup>(2)</sup>
Over consolidated stiff clay	20	24	2.53	2.53	1.99	1.99
Silty sandy clay	19	26	2.87	2.87	2.11	2.11
Loose sand and gravel	18	30	3.55	3.55	2.31	2.31
Medium dense sand and gravel	19	34	3.99	3.99	2.39	2.39
Dense sand and gravel	20	38	4.53	4.53	2.48	2.48

(1) Car parks: cars or light vehicles up to 9000 kg (GVW) in accordance with Table 4.2 of CIRIA Report C680.

(2) Landscaped areas where drive-on mowers are used in accordance with Table 4.2 of CIRIA Report C680.

Notes:

- weight of ground water taken as 10 kN·m<sup>-3</sup>
- angle of spread of wheel loadings taken as 27° in car parks with asphaltic surfacing and angle of internal friction of soil in landscaped areas
- no account is taken of accidental loading
- ground surface in vicinity of system assumed to be level
- formation below system assumed to have adequate bearing capacity
- partial load and material factors are defined in Table 7 of this Certificate
- values for distributed load and concentrated wheel loads/contact areas as defined in Table 4.1 of CIRIA Report C680.

**Table 10 Minimum cover depth**

	Landscaped areas <sup>(1)</sup>	Car park with vehicle mass <3000 kg <sup>(2)</sup>	Car park with occasional vehicle mass <9000 kg <sup>(3)</sup>
Minimum cover depth required (m)	0.50	0.50	0.75

(1) Landscaped areas where drive-on mowers are used in accordance with Table 4.2 of CIRIA Report C680.

(2) Driveways to individual houses and car parks with height barriers to limit vehicle size, cars up to 3000 kg GVW (eg people carrier) in accordance with Table 4.2 of CIRIA Report C680.

(3) Car parks: cars or light vehicles up to 9000 kg (GVW) in accordance with Table 4.2 of CIRIA Report C680.

Notes:

- calculations based on a system constructed from two layers of AquaCell Core units
- soil weight and angle of internal friction of the soil above the system taken as 20 kN·m<sup>-3</sup> and 38° respectively
- calculations based on there being no groundwater present
- angle of spread for wheel loads taken as 27° in car parks with asphaltic surfacing and angle of internal friction of soil in landscaped areas
- no account is taken of accidental loading
- ground surface in vicinity of system assumed to be level
- formation below system assumed to have adequate bearing capacity
- partial load and material factors are defined in Table 7 of this Certificate
- values for distributed and concentrated wheel loads/contact as defined in Table 4.1 of CIRIA Report C680
- calculation did not include dynamic factors or material factories for creep/fatigue.

## 8 Geotextiles and geomembranes

### Infiltration

8.1 The system requires a geotextile wrapping when used as an infiltration system to prevent:

- silt that may be contained in the surface water run-off contaminating the surrounding soil, in addition to reducing its permeability
- surrounding soil from entering the units.

8.2 The selection of an appropriate geotextile requires careful consideration (see section 8.6).

### Attenuation

8.3 The system requires a sealed geomembrane wrapping to create an attenuation storage system, to prevent:

- the release of surface water into the surrounding ground
- inflow of groundwater that may overload downstream systems and contain pollutants on contaminated sites.

8.4 Site conditions may also require the use of an additional thick, protective geotextile fleece to prevent puncture or excessive strain in the geomembrane. Further advice should be sought from the geomembrane manufacturer.

8.5 Selection of an appropriate geomembrane requires careful consideration (see section 8.7).

### Specification of geotextile

8.6 The selection of an appropriate geotextile for a specific AquaCell Core system should be considered carefully, particularly with reference to the surrounding soil properties and required performance. Points to consider are:

- pore size — this should be designed and specified to assist infiltration and prevent migration of fine soil particles
- permeability and breakthrough head — the geotextile should not limit flow of water in the system, and should have a similar or greater permeability than the surrounding ground

- puncture resistance — the geotextile must be able to resist piercing by potentially sharp objects, eg stones in the soil
- tensile strength — the geotextile should have sufficient strength to resist any imposed forces, eg from traffic
- specialist advice should be sought if surrounding soil characteristics exhibit a high degree of fines/low infiltration capacity and/or there is risk of damage from ground contaminants.

### Specification of geomembrane

8.7 The specification and selection of the impermeable geomembrane must be correct for the proposed installation, to ensure that it performs to the level required. It is essential that the specified material:

- withstands the rigours of installation
- resists puncture
- resists multi-axial elongation stress and strains associated with settlement
- resists environmental stress cracking
- resists damage from ground contaminants
- remains intact for the full design life.

8.8 A geomembrane less than 1 mm thick is unlikely to meet these criteria (except in shallow, domestic installations), and is not recommended for use with the system. For further details, the Certificate holder's advice should be sought.

8.9 All joints must be sealed using proprietary techniques recommended by the manufacturer. Advice on seam testing procedures is given in CIRIA Report SP 124 : 1996 *Barriers, liners and cover systems for containment and control of land contamination*.

## 9 Venting

9.1 Adequate venting must be provided to the system. One 110 mm diameter air vent is required per 7500 m<sup>2</sup> of impermeable catchment area to be drained (see Figure 4).

9.2 Typical air vent connectors and pipework are included in the Certificate holder's *AquaCell Systems — Product and Installation Manual*. It is recommended that all air vent installations in attenuation/storage applications (using an impermeable geomembrane) are made using a flange adaptor. Adhesive or double-sided tape should be used between the geomembrane and flange adaptor to ensure a watertight seal.

Figure 4 Typical air vent system

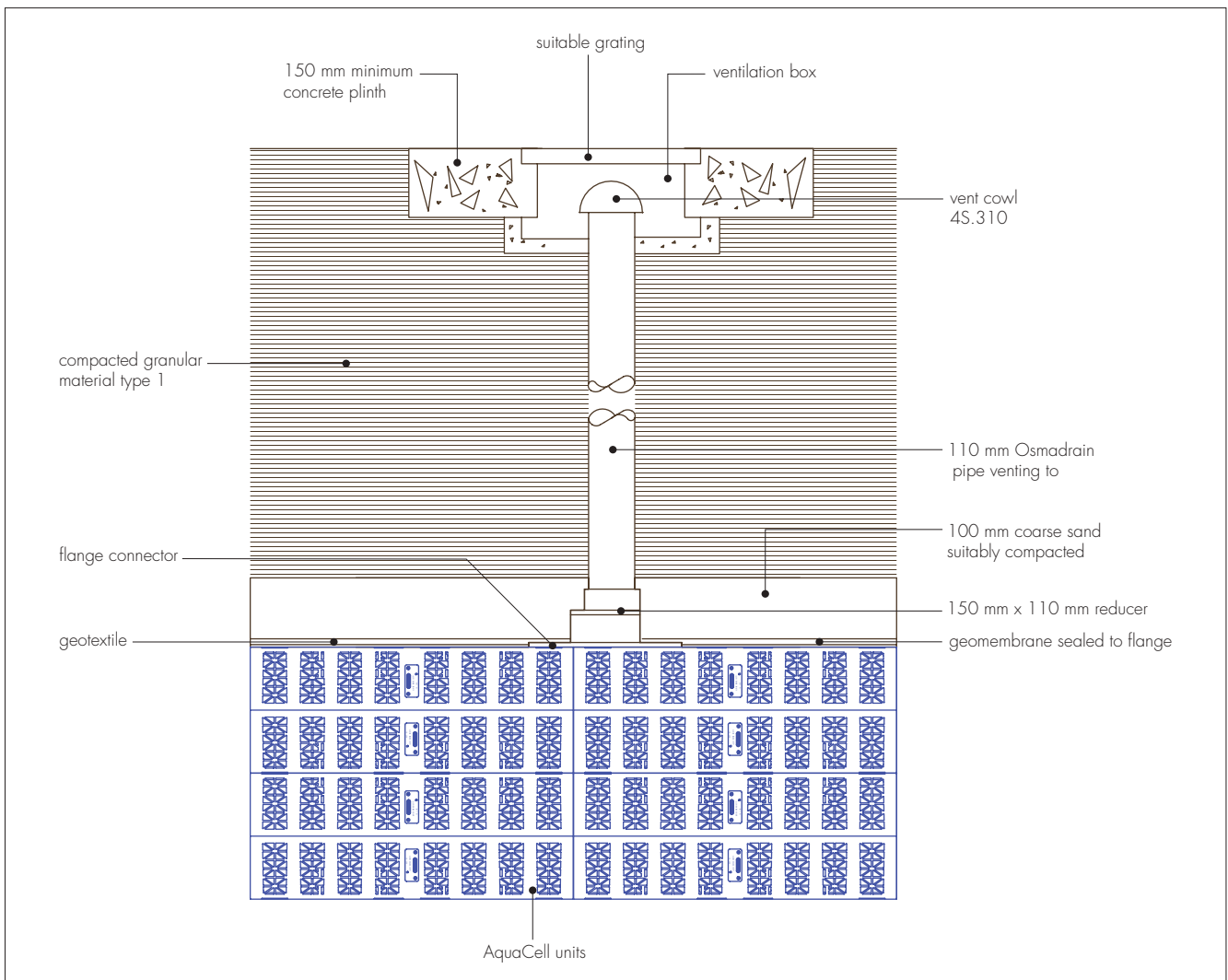

## 10 Resistance to chemicals

10.1 An assessment carried out by the BBA indicates that the system components are suitable for use in contact with the chemicals likely to be found in rainwater.

10.2 An assessment of the suitability for use of AquaCell Core units on brownfield sites should be made, only after a suitable site investigation, to determine the possibility for chemical attack. Particular care must be taken where acids and organic solvents are present at high concentrations. Further information can be obtained from the Certificate holder.

## 11 Maintenance

11.1 The owner of the structure is responsible for its maintenance.

11.2 For soakaways to individual houses, the only necessary maintenance of the system is to keep all gullies clear of debris, such as leaves.

11.3 For large installations, or where the receiving waters are environmentally sensitive, a programme of regular inspections should be established to prevent siltation of the system which, if allowed to develop, would reduce its effectiveness. The system should also be inspected after every major storm event.

11.4 It is recommended that a silt trap or sediment removal separator be installed upstream of the inlet pipework to the system (see Figure 5). A maintenance plan must be in place for regular cleaning of all traps and sumps to ensure correct performance. Silt traps and sediment removal separators for use with the system are outside the scope of this Certificate.

Figure 5 Typical silt trap

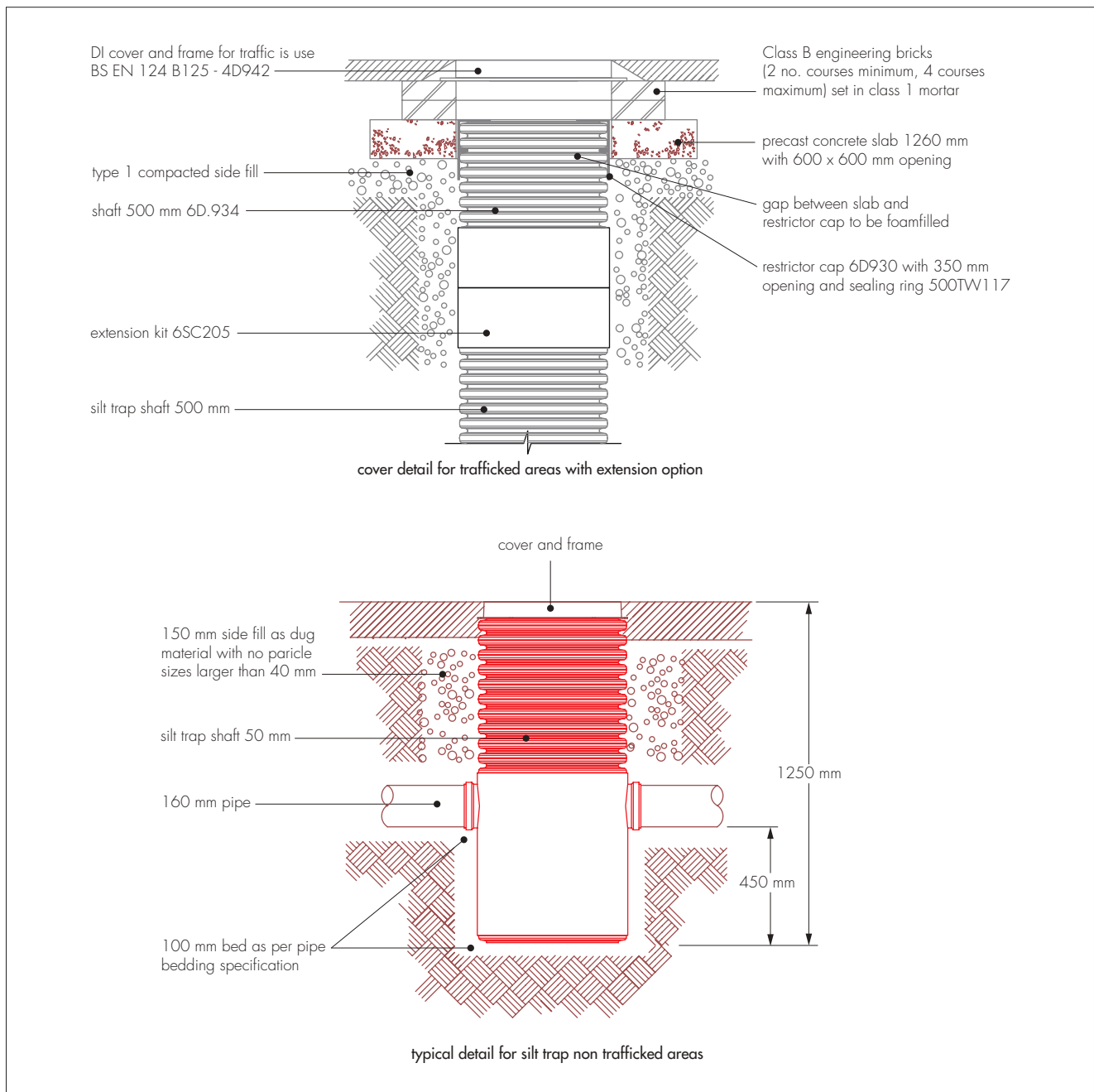

11.5 For all flow control devices, it is good practice to incorporate access (via a manhole or similar) to the location of the pipe entry, orifice or vortex control. This will enable easy removal of any blockage. The orifice itself may be protected by a debris screen.

11.6 Paved surface areas above an installation should be inspected at the same time as internal inspections, to ensure that the units continue to provide the required structural support.

## 12 Durability



The structural properties of polypropylene used in the system components will deteriorate with time, and this should be taken into account at the design stage by the application of suitable safety factors. In the opinion of the BBA, AquaCell Core, when used in accordance with this Certificate, will have a life in excess of 50 years.

## 13 Reuse and recyclability

The units are made from polypropylene, which can be recycled.

# Installation

## 14 General

The system should be installed in accordance with the Certificate holder's *AquaCell Systems — Product and Installation Manual*.

## 15 Procedure

15.1 The hole or trench is excavated to the required depth, dimensions and levels. It must be ensured that the plan area is sufficient to allow plant access around sides to compact backfill material (300 mm minimum). The base must be smooth and level without sharp drops or humps. Slopes must be cut to a safe angle or adequately supported, and safe access must be provided to allow personnel to enter the excavation.

15.2 The base must be inspected for soft spots in the formation; any present must be excavated and replaced with compacted granular fill material.

15.3 A 100 mm thick bedding layer of coarse sand is laid on the base and sides of the excavation. If required in attenuation systems, a layer of geotextile is laid to protect the impermeable geomembrane.

15.4 The impermeable geomembrane (or geotextile, if in an infiltration system) is laid over the sand bedding layer and up the sides of the excavation. The impermeable geomembrane is inspected for damage and all welds are tested as required. Joints between adjacent sheets of impermeable membrane should be sealed correctly using proprietary techniques with a minimum lap of 50 mm. Jointing with tape is not recommended as the system then becomes reliant on the mechanical properties of the tape to maintain its integrity.

15.5 The AquaCell Core units are installed in accordance with the installation schedule for correct orientation. Wherever possible, continuous vertical joints should be avoided. The units are arranged so that preformed sockets are in the correct alignment for inlet and outlet pipes. For single-layer applications, AquaCell clips are used and, for multilayers, AquaCell clips and shear connectors.

15.6 The geotextile or impermeable geomembrane encapsulation to base, sides and top of installation, including protective geotextile (if required to protect the geomembrane) is completed. Impermeable geomembranes should be welded with double seams. All welds should be tested as required and the membrane inspected for damage.

15.7 Drainage connections are made to the installation using proprietary adaptors. Preformed socket positions for pipe connections must be located at the correct position for receiving pipework. Alternatively, flange adaptors are used attached to AquaCell Core units with adhesive tape and self-tapping screws (flange adaptors cannot be used at the invert of AquaCell Core units into the preformed socket). It is recommended that all connections and air vent installations, in attenuation/storage applications, are made with a flange adaptor using adhesive or double-sided tape to form a seal. Alternatively, drainage connections are sealed into a preformed socket using proprietary seals approved by the geomembrane manufacturer.

15.8 The installation is backfilled with Type 1 or 2 sub-base or Class 6P (side fill only) selected granular material in accordance with the *Manual of Contract Documents for Highway Works (MCHW)*, Volume 1. The backfill is compacted in 150 mm thick layers.

15.9 A coarse sand protection layer, 100 mm thick, should be placed over the top of the units that have been wrapped. Backfilling is continued with:

- trafficked areas (eg car parks) — Type 1 or 2 sub-base material compacted in 150 mm layers in accordance with the MCHW, Volume 1. Compaction plant over the top of the system must not exceed 2300 kg per metre width
- landscaped and non-trafficked areas — selected as-dug material, with size of pieces less than 75 mm, compacted to 90% maximum dry density. Compaction plant over the top of the system must not exceed 2300 kg per metre width.

15.10 Pavement construction or landscaping over the system is completed.

### 16 Tests

Tests were carried out on the system and the results assessed to determine:

- long- and short-term resistance to loading
- performance and durability
- volumetric capacity and discharge rate.

### 17 Investigations

17.1 The manufacturing process was evaluated, including the methods adopted for quality control, and details were obtained of the quality and composition of the materials used.

17.2 An assessment of the system was made in relation to material properties and design procedures.

17.3 A site visit was made to assess the practicability and ease of installation and connection.

## Bibliography

BS EN 752 : 2008 *Drain and sewer systems outside buildings*

BS EN 13476-3 : 2007 + A1 : 2009 *Plastics piping systems for non-pressure underground drainage and sewerage — Structured-wall piping systems of unplasticized poly(vinyl chloride) (PVC-U), polypropylene (PP) and polyethylene (PE) — Specifications for pipes and fittings with smooth internal and profiled external surface and the system, Type B*

BS EN ISO 9001 : 2008 *Quality management systems — Requirements*

Manual of Contract Documents for Highway Works, Volume 1 *Specification for Highway Works*

## 18 Conditions

18.1 This Certificate:

- relates only to the product/system that is named and described on the front page
- is issued only to the company, firm, organisation or person named on the front page — no other company, firm, organisation or person may hold or claim that this Certificate has been issued to them
- is valid only within the UK
- has to be read, considered and used as a whole document — it may be misleading and will be incomplete to be selective
- is copyright of the BBA
- is subject to English Law.

18.2 Publications, documents, specifications, legislation, regulations, standards and the like referenced in this Certificate are those that were current and/or deemed relevant by the BBA at the date of issue or reissue of this Certificate.

18.3 This Certificate will remain valid for an unlimited period provided that the product/system and its manufacture and/or fabrication, including all related and relevant parts and processes thereof:

- are maintained at or above the levels which have been assessed and found to be satisfactory by the BBA
- continue to be checked as and when deemed appropriate by the BBA under arrangements that it will determine
- are reviewed by the BBA as and when it considers appropriate.

18.4 The BBA has used due skill, care and diligence in preparing this Certificate, but no warranty is provided.

18.5 In issuing this Certificate, the BBA is not responsible and is excluded from any liability to any company, firm, organisation or person, for any matters arising directly or indirectly from:

- the presence or absence of any patent, intellectual property or similar rights subsisting in the product/system or any other product/system
- the right of the Certificate holder to manufacture, supply, install, maintain or market the product/system
- actual installations of the product/system, including their nature, design, methods, performance, workmanship and maintenance
- any works and constructions in which the product/system is installed, including their nature, design, methods, performance, workmanship and maintenance
- any loss or damage, including personal injury, howsoever caused by the product/system, including its manufacture, supply, installation, use, maintenance and removal
- any claims by the manufacturer relating to CE marking.

18.6 Any information relating to the manufacture, supply, installation, use, maintenance and removal of this product/system which is contained or referred to in this Certificate is the minimum required to be met when the product/system is manufactured, supplied, installed, used, maintained and removed. It does not purport in any way to restate the requirements of the Health and Safety at Work etc. Act 1974, or of any other statutory, common law or other duty which may exist at the date of issue or reissue of this Certificate; nor is conformity with such information to be taken as satisfying the requirements of the 1974 Act or of any statutory, common law or other duty of care.

### Description:

AquaCell Core has been designed for use in deep applications, subject to both regular and heavy traffic loadings, such as cars and HGV's (for vehicles up to 44 tonnes).



### Technical Specification:

Part Number	6LB100
Unit Colour	Dark Blue
Dimensions	1m x 0.5m x 0.4m
Weight	9.3kg
Volume	190 litres
Void Ratio	95%
Material	Virgin PP
Vertical Loading	56 tonnes/m <sup>2</sup>
Lateral Loading	7.7 tonnes/m <sup>2</sup>

### Typical Maximum Installation Depths:

Landscaped areas	4.25m
Trafficked by cars	4.1m
Trafficked by HGVs	4m
BBA approval	Yes (Certificate 03/4018)

### Maximum installation depths (to base units)

Typical soil type	Typical angle of shearing resistance ( <sup>1</sup> )( <sup>2</sup> ) ( $\phi$ )	Maximum depth of installation – to base of units (m)			
		With groundwater at 1m below ground level and units wrapped in geomembrane		Without groundwater below base of units (normal case)	
		Trafficked areas (cars only) ( <sup>3</sup> )	Non-trafficked areas	Trafficked areas (cars only) ( <sup>3</sup> )	Non-trafficked areas
Stiff over-consolidated clay (e.g. London clay)	24°	1.65	1.75	2.35	2.50
Normally consolidated silty, sandy clay (e.g. alluvium, made ground)	26°	1.70	1.80	2.50	2.65
Loose sand and gravel	29°	1.80	1.90	2.85	2.95
Medium dense sand and gravel	33°	1.90	2.00	3.30	3.45
Dense sand and gravel	38°	2.05	2.15	4.10	4.25

- (1) Loosening of dense sand or softening of clay by water can occur during installation. The designer should allow for any such likely effects when choosing an appropriate value of  $\phi$ .
- (2) The design is very sensitive to small changes in the assumed value of  $\phi$ , therefore, it should be confirmed by a chartered geotechnical engineer. In clay soils, it may be possible to utilise cohesion in some cases.
- (3) Applicable for car parks or other areas trafficked only by cars or occasional refuse collection trucks or similar vehicles (typically one per week).  
Assumptions made are:
- ground surface is horizontal
  - shear planes or other weaknesses are not present within the structure of the soil

Source: BBA

Wavin Limited operates a programme of continuous product development, and therefore reserves the right to modify or amend the specification of their products without notice. All information in this publication is given in good faith, and believed to be correct at the time of going to press. However, no responsibility can be accepted for any errors, omissions or incorrect assumptions. Users should satisfy themselves that products are suitable for the purpose and application intended.

# Water Management PRODUCT AND INSTALLATION MANUAL



CONNECT TO BETTER

# AquaCell Systems

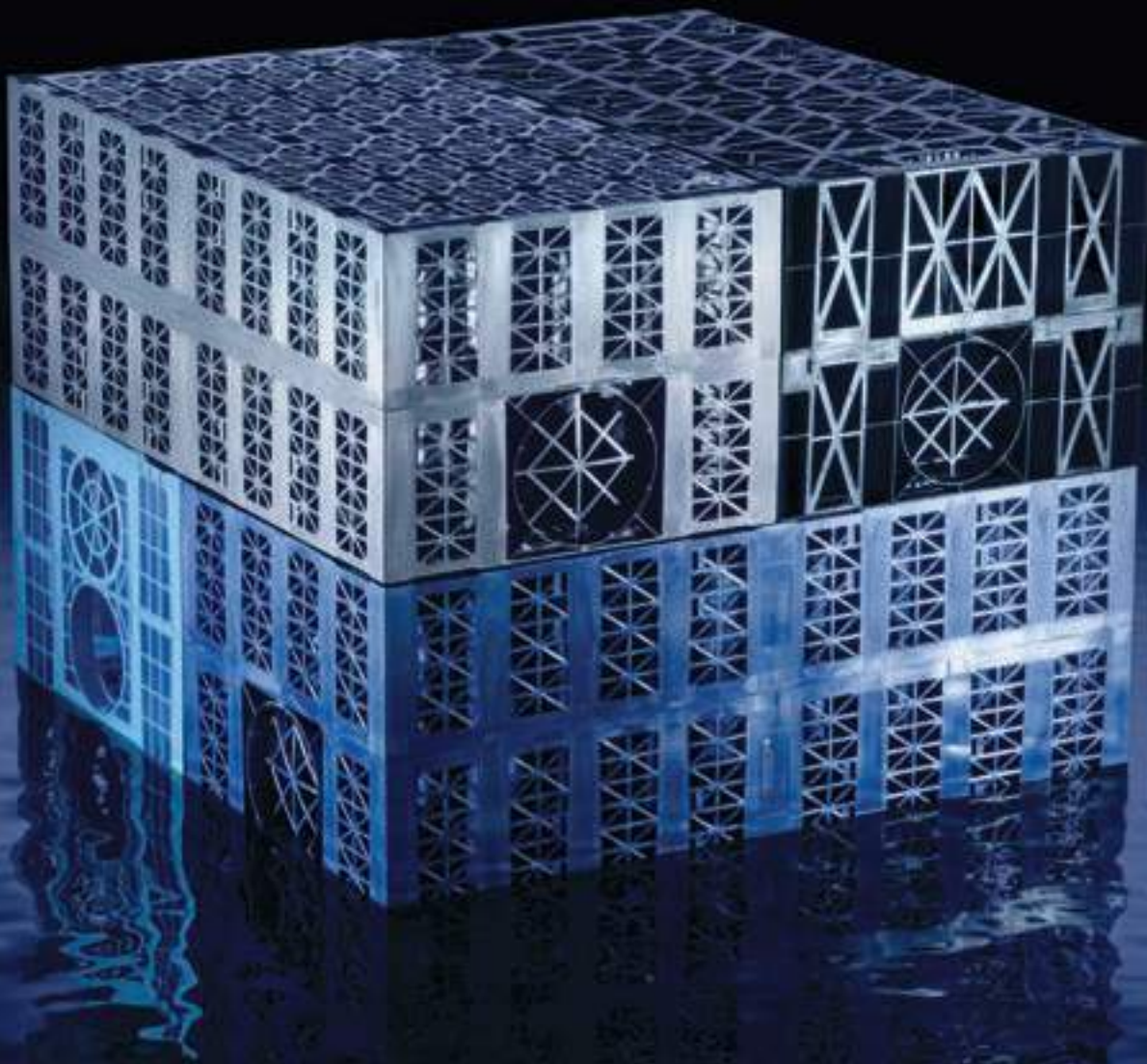

# Contents

## AquaCell Systems

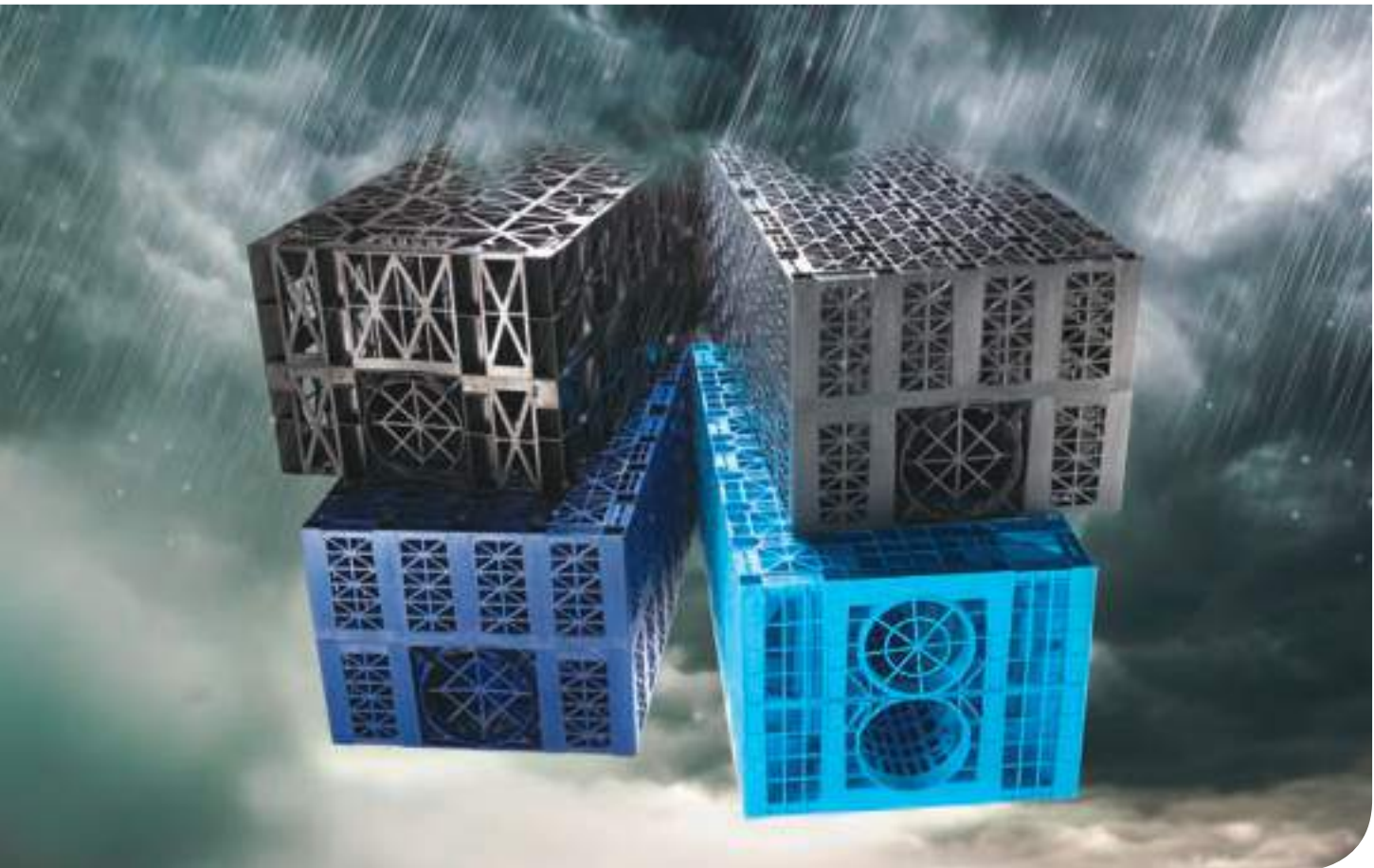

<b>Introduction to SuDS</b>	<b>4</b>	<b>Installation</b>	<b>20</b>	Off-Line Storage – Manifold Feed	32
<b>Keeping you on top of legislation</b>	<b>5</b>	Typical Soakaway		Off-Line Storage – Central	
<b>Overview</b>	<b>6</b>	Installation Method	20	Pipe Feed	33
<b>Product Range Summary</b>	<b>8</b>	Typical Storage Tank		Soakaway or Storage Tank	
<b>Product Details</b>	<b>9</b>	Installation Method	21	– With Silt Trap	34
AquaCell Eco	9	Silt Trap and Air Vent Termination	22	<b>Wavin Stormwater Management</b>	<b>35</b>
AquaCell Prime	10	<b>Typical Details</b>	<b>23</b>	To Achieve Optimum Stormwater	
AquaCell Core	11	Top Connection for Air Vent	23	Management	35
AquaCell Plus	12-13	Side Connection for Air Vent	23	Other Wavin Stormwater Systems	35
<b>Design Guidance</b>	<b>14-18</b>	Connections to AquaCell Units	24	The Wavin Stormwater Service	35
<b>Installation Guidance</b>	<b>19</b>	Connection Configurations	25	<b>Product Details</b>	
AquaCell Prime, Core and Plus:		Soakaway – Non-Traffic Loading	26	<b>Supplementary Items</b>	<b>36</b>
Construction Loads	19	Soakaway – Traffic Loading	27	Silt Traps	36
AquaCell Eco: Construction Loads	19	On-Line Storage – Box Feed	28	Ancillaries	37-38
		On-Line Storage – Manifold Feed	29	Spares	39
		On-Line Storage – Central			
		Pipe Feed	30		
		Off-Line Storage – Box Feed	31		

# Introduction to SuDS

Continuing urban development, a changing climate and the consequences of increased rainfall are all increasingly prominent issues on the political and environmental agenda and all drive the need to actively manage excessive rainfall with the use of SuDS (Sustainable Drainage Systems).

SuDS techniques recommend a number of ways to control water run-off as near to where it falls, via:

- ⌚ Soft or natural SuDS
- ⌚ Hard or engineered SuDS

SuDS should also aim to mimic nature, whilst focusing on 4 key areas (as shown below):

1. Controlling run-off / flood risk
2. Improving water quality
3. Providing amenities
4. Creating an environment for biodiversity

The CIRIA SuDS Manual gives guidance on all areas of SuDS and focuses on the cost-effective planning, design, construction, operation and maintenance of SuDS.

## Which SuDS Techniques are best?

- ⌚ SuDS should help maximise amenity and biodiversity, whilst also delivering key objectives to manage flood risk and water quality
- ⌚ For any given site, it is often beneficial to include a combination of 'soft' and 'hard' SuDS to ensure maximum efficiency from the Sustainable Drainage System

## How can the Wavin help with SuDS projects?

Wavin is well qualified to advise on how to comply with current and emerging regulation. We can aid specifiers, developers and contractors in responding to legislative demands as they pertain to flooding, sewage, urban drainage and sustainable resources use.

In particular, the proven qualities and performance of AquaCell systems not only support the achievement of SuDS, they can also help reinforce and enhance planning applications and enable development to proceed.

## CIRIA SuDS Design

Source: The SuDS Manual (CIRIA)

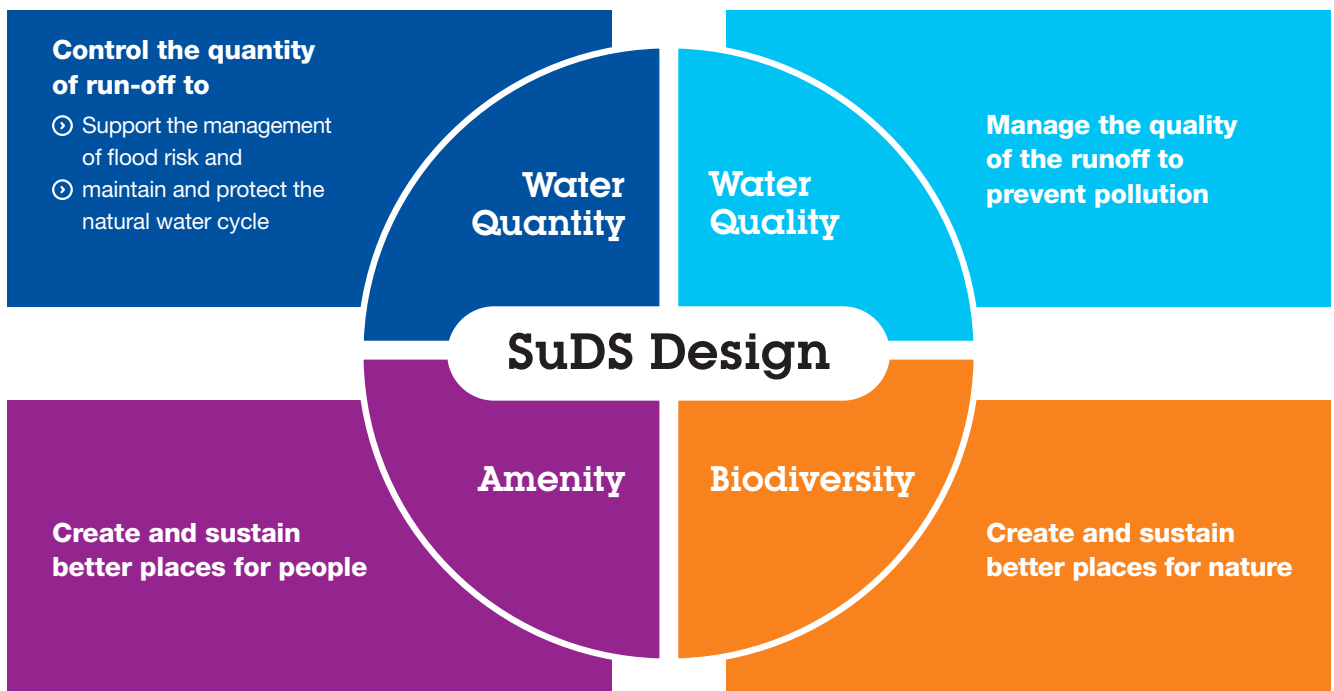

# Keeping you on top of legislation

## Flood and Water Management Act 2010

Climate projections suggest that extreme weather will happen more frequently in the future. The Flood and Water Management Act is designed to reduce the risk of flooding and its consequences by providing for better, more comprehensive and co-ordinated water management, embracing groundwater, surface water and coastal erosion risk.

The Act gives DEFRA responsibility for establishing national standards for sustainable drainage and empowers local authorities to manage local flood risk – adapting and maintaining sustainable drainage schemes.

Specifically with regards to stormwater, Building Regulations Approved Document H3 stipulates that adequate provision should be made for rainwater to be carried from the roof of a building to either a soakaway, water course or sewer.

## The EU Water Framework Directive

Nearly half the EU population lives in ‘water-stressed’ countries, caused by high extraction from freshwater sources, and demand is growing all the time.

The EU Water Framework Directive introduces a new legislative approach designed to better manage and protect water resources, based not on national or political boundaries but on the natural formations of river basins.

## Building Regulation Part H (Drainage and Waste Disposal)

Building Regulation Part H embraces the guidelines for drainage and waste disposal that must be met in the UK.

Although Part H extends to rainwater drainage and solid waste storage, waste drainage issues are to the fore. The Building Regulations are designed to ensure that all foul water (waste from urinals, portals, food preparation water etc.) is properly disposed of to maintain a decent level of sanitation, promoting both personal and environmental health.

The regulations also highlight the importance of pollution prevention, working sewage infrastructure and sewage maintenance.

## Planning Policy

Statement 25: Development and Flood Risk Responding to climate change, and replacing Planning Policy Guidance Note 25, the statement PPS25 sets out policy to ensure that flood risk is taken into account at all stages of the planning process and that inappropriate development in areas at risk of flooding is avoided.

The policy directs development away from areas of highest risk and where new development is, exceptionally necessary in such areas, aims to make it safe without creating an increase in flood risk elsewhere and, where possible, reduce flood risk overall.

Statement 3: Housing PPS3 underpins the delivery of the Government’s strategic housing policy objectives. The statement replaces Planning Policy Guidance 3: Housing and earlier editions of PPS3, providing technical amendments to Annex B: Definitions to reflect the introduction of Affordable Rent.



# Overview AquaCell Systems

The AquaCell range of geocellular systems are a fully tried and tested, BBA approved, modular technique for managing excessive rainfall.

## Applications

The AquaCell range can be used as either a temporary storage tank or as a soakaway, and is suitable for applications including:

- Ⓞ Landscaped areas
- Ⓞ Parks
- Ⓞ Domestic gardens
- Ⓞ Residential developments
- Ⓞ Car parks & roads
- Ⓞ Industrial/commercial areas



## The AquaCell Range

There are four types of AquaCell unit. Each can be used as a standalone system or different unit types can be mixed and matched together in layers to value engineer the most cost effective solution.

All AquaCell units have identical dimensions (1m x 0.5m x 0.4m), but they are manufactured to perform differently. The type of unit, or combination of units required will depend on factors such as the load application, overall installation depth and site conditions.

## Features & benefits

The following are applicable to all AquaCell units:

- Ⓞ Fully BBA Approved – Eco/Prime/Core/Plus are all approved under certificate No. 03/4018
- Ⓞ Modular, lightweight and versatile
- Ⓞ Easy to handle and quick to install
- Ⓞ Proven clip and peg connection system
- Ⓞ 95% void (each unit holds 190 litres of water)
- Ⓞ Can be brick-bonded for extra stability
- Ⓞ Units can be mixed and matched together for optimum performance
- Ⓞ Safer than open or above ground storage structures
- Ⓞ Full range of ancillaries
- Ⓞ Can be used as part of a SuDS scheme to help reduce flood risk

## Environmental Benefits

In addition, the AquaCell range can also offer the following environmental benefits:

- Ⓞ Significantly reduced flooding risk
- Ⓞ Controlled, reduced-volume release of stormwater into existing sewer systems or watercourses
- Ⓞ Recharging of local groundwater (if infiltration/soakaway application)
- Ⓞ Aerobic purification to improve water run-off quality
- Ⓞ Sustainable, cost effective management of the water environment



## AquaCell Eco



Eco is manufactured from specially reformulated, recycled material and has been designed for shallow, non-trafficked, landscape applications.

## AquaCell Prime



Prime is the latest addition to the AquaCell range, manufactured from specially reformulated, recycled material. It is ideal for use in both shallow and deep applications, subject to either regular traffic loading – such as car parks (for vehicles up to 12 tonnes) – or for landscaped areas.

## AquaCell Core



Core has been designed for use in deep applications, subject to both regular and heavy traffic loadings, such as cars and HGV's (for vehicles up to 44 tonnes).

## AquaCell Plus



Plus has been designed primarily for use in applications where inspectability is required, and is suitable for use in all applications from landscaped areas to heavily trafficked areas (for vehicles up to 44 tonnes).

### Optimise tank and soakaway designs with the AquaCell Configurator Tool

The AquaCell configurator tool aids and speeds the efficient design of stormwater tank or soakaway solutions. The tool guides users through a step-by-step specification process and, based on responses, will recommend the optimum design, based on the loadings, depths and site conditions of each project. The tool generates a PDF of the design for easy download and can store the data online for future reference. To start using the tool or to learn more visit: [myportal.wavin.co.uk/tools](http://myportal.wavin.co.uk/tools)



# Product Range Summary

## AquaCell Systems

The Product Range Summary below lists all components available to be used in conjunction with the AquaCell range.

### Abbreviations

**P/E** – Fittings with both ends plain or with one plain end and one special end.

**S/S** – Fittings with one or more ring-seal or push-fit sockets, but always one plain or special end.

**D/S** – Fittings with ring-seal or push-fit sockets at all ends.

▲ **British Board of Agrément** – BBA logo identifies non-Kitemarked fittings covered by British Board of Agrément Certificate

Table 1: The Product Range Summary

Product Description	Inlet Size (mm)	110	150	160	225	Page
<b>Modular Units</b>	AquaCell Eco – 1m x 0.5 x 0.4m ▲			●		9
	AquaCell Prime – 1m x 0.5 x 0.4m ▲			●		10
	AquaCell Core – 1m x 0.5 x 0.4m ▲			●		11
	AquaCell Plus – 1m x 0.5 x 0.4m ▲			●		12
<b>Silt Traps</b>	Silt Trap – Domestic	●				36
	Extension Piece – for Domestic Silt Trap					36
	Silt Bucket - for Domestic Silt Trap					36
	Silt Trap - Trafficked			●		36
<b>Ancillaries</b>	S/S Adaptor – UltraRib		●			37
	S/S Level Invert Reducer – 160mm UltraRib to 110mm spigot		●			37
	S/S Adaptor – TwinWall 6TW socket x 160mm OsmaDrain spigot		●			37
	S/S Level Invert Reducer – 160mm OsmaDrain to 110mm spigot			●		38
	P/E Adaptor – Solid Wall 160mm OsmaDrain spigot			●		38
	Flange Adaptor – for 150mm UltraRib connections		●			38
	Flange Adaptor – for 225mm UltraRib connections				●	38
<b>Spares</b>	AquaCell Clip – for use with all types of AquaCell units					39
	AquaCell Shear Connector – for use with all types of AquaCell units					39
	AquaCell Plus End Cap			●		39

# Product Details AquaCell Eco

## Application

AquaCell Eco is manufactured from specially reformulated, recycled material and has been specifically designed for shallow, non-trafficked, landscaped applications. AquaCell Eco is **NOT** suitable for locations subject to high water tables.

AquaCell Eco is typically suitable for installations to a maximum depth of 1.5 metres, to the base of the units from ground level, with a minimum cover depth of 0.3 metres, (Wavin's recommendation, is to allow a cover depth of 0.5 metres).

Any installation using AquaCell Eco must **NOT** be subjected to additional loading at any time. Trafficking by construction plant on site, including mechanical equipment, must be avoided.

If trafficking of the buried tank by construction plant or, other vehicles is unavoidable, the installation should be constructed using AquaCell Core units (see page 11).

The width of an AquaCell Eco installation should not exceed 12 metres to allow for mechanical backfilling without loading. There is no limit to the length of the installation.

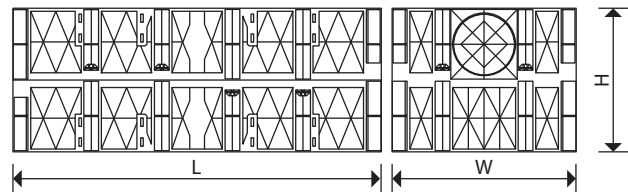

Material: Reformulated polypropylene

Nominal Size (mm)	Part Number	Dimensions (mm)		
		W	H	L
160	6LB025	500	400	1000

## Features and benefits

- ⦿ Manufactured from specially reformulated, recycled material
- ⦿ Suitable for both soakaway and attenuation applications
- ⦿ Proven vertical loading capacity of: 17.5 tonnes/m<sup>2</sup>
- ⦿ Proven lateral loading capacity of: 4.0 tonnes/m<sup>2</sup>
- ⦿ Integral "hand holds" for ease of carrying/handling
- ⦿ Black in colour, for ease of identification
- ⦿ BBA approved – Certificate No 03/4018

**APPROVED**

17.5 tonnes/m<sup>2</sup>

4 tonnes/m<sup>2</sup>

**LOADING**

**MAX  
INVERT  
DEPTH  
1.5m**

NON-LOADED

**MIX  
AND  
MATCH**

Maximum installation depths (to base units) and minimum cover depths <sup>(1)</sup>

Typical soil type	Typical angle of shearing	Maximum depth of installation (m)	Minimum cover depth (m)
Stiff over-consolidated clay (e.g. London clay)	24°	0.95	0.30
Normally consolidated silty, sandy clay (e.g. alluvium, made ground)	26°	1.05	0.30
Loose sand and gravel	29°	1.2	0.30
Medium dense sand and gravel	33°	1.5	0.30
Dense sand and gravel	38°	1.9	0.30

(1) These values relate to installations where the groundwater is a minimum of one metre below the base of the excavation. AquaCell Eco units should not be used where groundwater is present.

Source: BBA

# Product Details

## AquaCell Prime

### Application

AquaCell Prime is manufactured from specially reformulated, recycled material. It is ideal for use in both shallow and deep applications, subject to either regular traffic loading – such as car parks (for vehicles up to 12 tonnes) or for landscaped areas.

Typically AquaCell Prime is suitable for installations to a maximum depth of 3.70m in landscaped areas (3.45m trafficked) to the base of the units from ground level, in best soil conditions.

### Features and benefits

- ⦿ Manufactured from specially reformulated, recycled material
- ⦿ Suitable for both soakaway and attenuation applications
- ⦿ Suitable for regular traffic loading, e.g. car parks
- ⦿ Proven vertical loading capacity of: 45.6 tonnes/m<sup>2</sup>
- ⦿ Proven lateral loading capacity of: 7 tonnes/m<sup>2</sup>
- ⦿ Grey in colour, for ease of identification
- ⦿ BBA approved – Certificate No 03/4018
- ⦿ Ideal for major attenuation and infiltration schemes

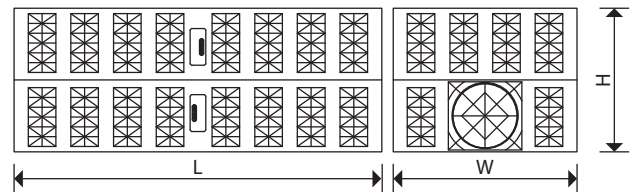
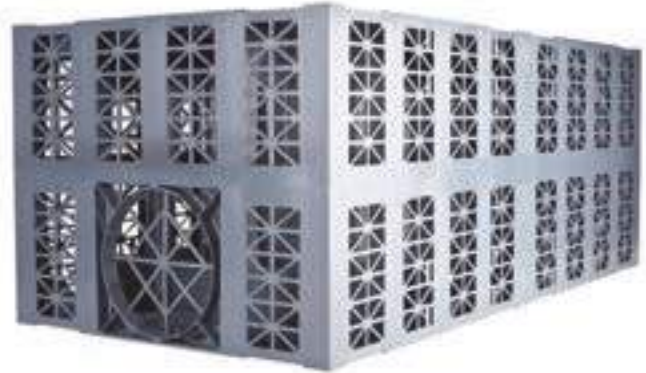

Material: Reformulated polypropylene

Nominal Size (mm)	Part Number	Dimensions (mm)		
		W	H	L
160	6LB075	500	400	1000



Maximum installation depths (to base units)

Typical soil type	Typical angle of shearing resistance (1) (2) (φ)	Maximum depth of installation – to base of units (m)			
		With groundwater at 1m below ground level and units wrapped in geomembrane		Without groundwater below base of units (normal case)	
		Trafficked areas (cars only) (3)	Non-trafficked areas	Trafficked areas (cars only) (3)	Non-trafficked areas
Stiff over-consolidated clay (e.g. London clay)	24°	1.60	1.78	1.73	1.98
Normally consolidated silty, sandy clay (e.g. alluvium, made ground)	26°	1.75	1.90	2.01	2.27
Loose sand and gravel	30°	1.95	2.08	2.58	2.86
Medium dense sand and gravel	34°	2.04	2.16	2.98	3.24
Dense sand and gravel	38°	2.14	2.24	3.45	3.70

- (1) Loosening of dense sand or softening of clay by water can occur during installation. Designer to factor in when selecting φ value.
- (2) The design is very sensitive to small changes in the assumed value of φ, therefore, it should be confirmed by a chartered geotechnical engineer. In clay soils, it may be possible to utilise cohesion in some cases.
- (3) Applicable for car parks or other areas trafficked only by cars or occasional refuse collection trucks or similar vehicles (typically one per week). Assumptions made are: ⦿ ground surface is horizontal ⦿ shear planes or other weaknesses are not present within the structure of the soil

Source: BBA

# Product Details AquaCell Core

## Application

AquaCell Core has been designed for use in deep applications, subject to regular and heavy traffic loadings, e.g. cars and HGV's (for vehicles up to 44 tonnes). AquaCell Core can also be used for deep soakaways and landscaped applications.

Typically for use down to depths of 4.25m in landscaped areas (4.1m trafficked by cars and 4m trafficked by HGV's) to the base of the units from ground level, in best soil conditions.

Trafficking by heavy construction plant on site, including mechanical equipment, must be avoided until the minimum cover depth of 0.9 metres is in place.



## Features and benefits

- ⦿ Suitable for regular and heavy traffic loadings
- ⦿ Proven vertical loading capacity of: 56 tonnes/m<sup>2</sup>
- ⦿ Proven lateral loading capacity of: 7.7 tonnes/m<sup>2</sup>
- ⦿ Dark blue in colour, for ease of identification
- ⦿ BBA approved – Certificate No 03/4018
- ⦿ Ideal for all types of shallow and deep projects including major attenuation and infiltration schemes

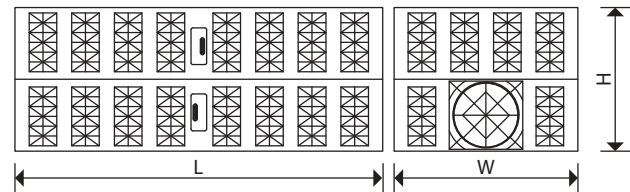

Material: Polypropylene

Nominal Size (mm)	Part Number	Dimensions (mm)		
		W	H	L
160	6LB100	500	400	1000



Maximum installation depths (to base units)

Typical soil type	Typical angle of shearing resistance (1) (2) (φ)	Maximum depth of installation – to base of units (m)			
		With groundwater at 1m below ground level and units wrapped in geomembrane		Without groundwater below base of units (normal case)	
		Trafficked areas (cars only) (3)	Non-trafficked areas	Trafficked areas (cars only) (3)	Non-trafficked areas
Stiff over-consolidated clay (e.g. London clay)	24°	1.65	1.75	2.35	2.50
Normally consolidated silty, sandy clay (e.g. alluvium, made ground)	26°	1.70	1.80	2.50	2.65
Loose sand and gravel	29°	1.80	1.90	2.85	2.95
Medium dense sand and gravel	33°	1.90	2.00	3.30	3.45
Dense sand and gravel	38°	2.05	2.15	4.10	4.25

(1) Loosening of dense sand or softening of clay by water can occur during installation. Designer to factor in when selecting φ value.

(2) The design is very sensitive to small changes in the assumed value of φ, therefore, it should be confirmed by a chartered geotechnical engineer. In clay soils, it may be possible to utilise cohesion in some cases.

(3) Applicable for car parks or other areas trafficked only by cars or occasional refuse collection trucks or similar vehicles (typically one per week). Assumptions made are: ⦿ ground surface is horizontal ⦿ shear planes or other weaknesses are not present within the structure of the soil

Source: BBA

# Product Details

## AquaCell Plus

### Application

AquaCell Plus has been designed primarily for use in applications where inspectability is required, and is suitable for use in all applications from landscaped areas to heavily trafficked areas (for vehicles up to 44 tonnes). The units can be used in combination with AquaCell Prime and Core (and Eco if there is at least one layer of Prime or Core in between the Plus and Eco layer).

Extra lateral loading capacity allows installation at greater depths. Integral inspection channels in each unit combine to create viewing channels for the full length of the installed structure.

Typically for use down to depths of 5.08m in landscaped areas (4.78m trafficked by cars and 4.48m trafficked by HGV's) to the base of the units from ground level, in best soil conditions. Trafficking by heavy construction plant on site, including mechanical equipment, must be avoided until the minimum cover depth of 0.9 metres is in place.

### Features and benefits

- ⦿ Suitable for extra deep installations
- ⦿ Inspectable (supplied with end cap for use when an inspection channel is not required)
- ⦿ Proven vertical loading capacity of: 65 tonnes/m<sup>2</sup>
- ⦿ Proven lateral loading capacity of: 8.5 tonnes/m<sup>2</sup>
- ⦿ Light blue in colour, for ease of identification
- ⦿ BBA approved – Certificate No 03/4018

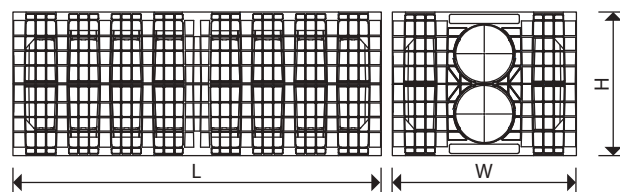

Material: Polypropylene

Nominal Size (mm)	Part Number	Dimensions (mm)		
		W	H	L
160	6LB200	500	400	1000

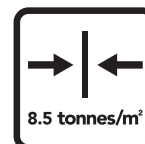
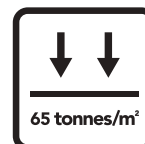

Maximum installation depths (to base units)

Typical angle of shearing resistance <sup>(1)</sup> <sup>(2)</sup> (ϕ)	Maximum depth of installation – to base of units (m)		
	Non-trafficked areas	Cars <sup>(3)</sup>	HGV
24°	2.96	2.65	2.35
26°	3.18	2.88	2.57
28°	3.42	3.12	2.82
30°	3.69	3.39	3.08
32°	3.98	3.68	3.38
34°	4.31	4.01	3.71
36°	4.68	4.38	4.07
38°	5.08	4.78	4.48

- (1) Loosening of dense sand or softening of clay by water can occur during installation. Designer to factor in when selecting ϕ value.
- (2) The design is very sensitive to small changes in the assumed value of ϕ, therefore, it should be confirmed by a chartered geotechnical engineer. In clay soils, it may be possible to utilise cohesion in some cases.
- (3) Applicable for car parks or other areas trafficked only by cars or occasional refuse collection trucks or similar vehicles (typically one per week). Assumptions made are: ⦿ ground surface is horizontal ⦿ shear planes or other weaknesses are not present within the structure of the soil

Source: BBA

# Product Details

## AquaCell Plus

### AquaCell Plus: for inspectability

By aligning AquaCell Plus units end-to-end, full length viewing channels can be created – allowing for CCTV inspection if required. These are created in the bottom layer of an AquaCell tank installation.

The units can be used in combination with AquaCell Prime and Core (and with Eco if there is at least one layer of AquaCell Prime or Core in between the Plus and Eco layer).

NOTE: For any AquaCell Plus units on the perimeter of a structure that are NOT required for inspection access, the open ends of the integral inspection tunnels should be fitted with the end caps provided.

### Inspection chambers

An inspection chamber should precede the inlet pipework for the AquaCell structure.

A silt trap or hydro-dynamic separator prior to the inspection chamber is also recommended.

For on-line installations the following Chambers are recommended:

- Down to 3m Wavin Non-Entry Inspection Chambers
- Down to 5m Wavin Range 600 Inspection Chambers, or a traditional manhole\*

*\*where inlet pipework is replaced by AquaCell units acting as flow conduit.*

For off-line installations:

- Manhole with in-built flow control

Recommendation: If installing any Wavin Non-Entry Inspection Chamber, deeper than 1.2 metres, ensure that the cover and frame includes a 350mm restrictor to prevent man entry.

### Inspection and maintenance

CCTV inspection at every inspection point is recommended:

- after every major storm
- at regular intervals according to the specific maintenance plan for the site

Silt traps prior to inlet pipework should be routinely inspected and cleaned out to minimise debris reaching the tank. It is important to prevent construction silt from entering the AquaCell structure.

### Inspectability Scenarios

#### AquaCell Plus viewing channel



#### Trafficked tank installation with inspection chambers

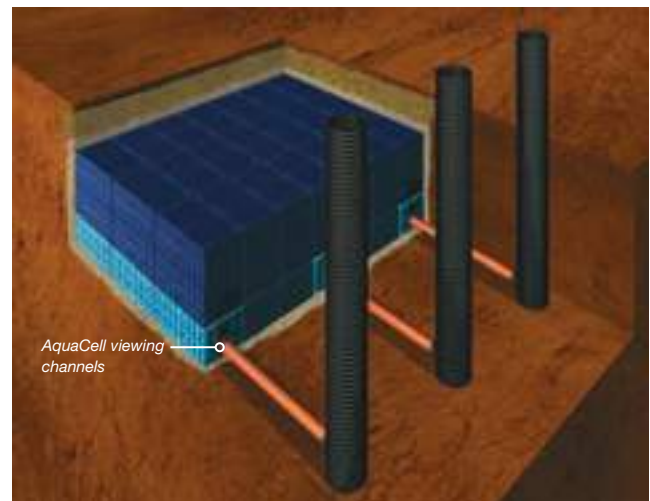

AquaCell Plus 6LB200

# Design Guidance

# AquaCell Units

## Infiltration or attenuation?

The AquaCell range can be used either as:

- ① A soakaway whereby the units will be installed in suitable pervious soils so the units can be wrapped in a geotextile to allow infiltration of the stormwater into the surrounding ground, or
- ① As an attenuation tank in impervious ground (e.g. clay) where infiltration is not possible, here the units are encapsulated in a geomembrane (which is in turn wrapped in a protective geotextile layer) so that the structure can hold the stormwater temporarily until local drainage flows can accept it for normal disposal at a permissible outflow rate.

Large scale AquaCell Core storage tank



Domestic AquaCell Core soakaway



## Site assessment

Ground conditions may be established as part of a geotechnical assessment. This may include tests for infiltration and ground water level.

If there is no confirmation that such assessments have been conducted, or resulting conclusions are unavailable, a trial pit will be required in accordance with BRE 365.

For further information and guidance, please contact the Wavin Technical Design Team.

## Infiltration (soakaways)

According to the principals of SuDS, wherever possible stormwater should be drained back into the ground via a soakaway as the first priority. A site must meet BOTH of the following criteria for infiltration to be possible:

- ① The underlying soil surrounding the proposed installation is sufficiently permeable
- ① The seasonally high water table is a minimum of 1 metre below the base of the proposed installation

If either of these criteria is not met, or cannot be confirmed for any reason, a soakaway system may not be suitable for the application, in which case a storage tank must be used.

## Attenuation (Storage tanks)

A storage tank may be designed to be online or offline (see pages 28-33 for typical details). However, if the site is subject to groundwater or a high water table, it is important to ensure that the tank is not vulnerable to flotation. Sufficient weight from soil, or other covering placed over the AquaCell units, must be sufficient to counter any buoyancy uplift force from the rising groundwater level.

### Important design considerations for geocellular structures

Rising rainfall levels and increased focus on SuDS compliance, have led to a sharp increase in the use of modular units to create underground structures for infiltration or the temporary storage of stormwater.

However, not all currently available systems have the proven performance characteristics necessary to meet the wide range of complex underground geocellular applications.

The Wavin range of AquaCell units provide assured performance, since all strength and hydraulic capabilities have been verified by independent testing and all units are fully BBA approved.

To guarantee the structural integrity of an engineered drainage system, any underground structure must be strong enough to support the loads to which it will be subjected without any unacceptable deflection.

The correct choice of geocellular unit must have appropriate proven top (vertical) and side (lateral) load bearing capacity and deflection characteristics to suit site conditions.

The five key site considerations to be noted when designing a geocellular structure are:

1. Depth of cover (See page 16)
2. Soil type
3. Surface finishing
4. Presence of groundwater
5. Type of traffic/loading

The combination of these 5 factors effectively means that the

Non-trafficked

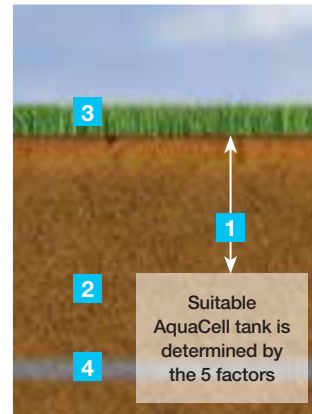

Trafficked

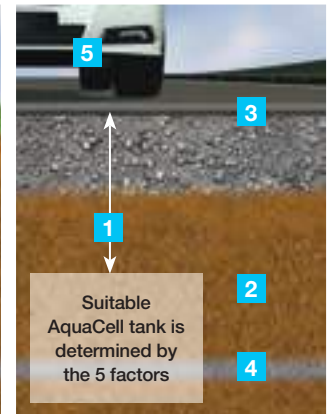

required characteristics of a geocellular structure to be installed under a trafficked location (for example) will be very different from that under a landscaped/low-loaded location.

Two typical examples are given below.

EXAMPLE A: Landscaped/non-trafficked location and 0.3m cover depth. Typically requires minimum vertical strength of 17.5 tonnes/m<sup>2</sup>

EXAMPLE B: Car park with occasional light delivery traffic and between 0.71 – 0.75m cover depth. Typically requires minimum vertical strength of 40 tonnes/m<sup>2</sup>

# Design Guidance AquaCell Units

## Hydraulic Design

All AquaCell units have identical dimensions: 1m x 0.4m x 0.5m, have a nominal void ratio of 95% and each holds 190 litres of water. Hydraulic calculations are accordingly the same for AquaCell Eco, Prime, Core and Plus.

Structural design however, requires careful consideration of loading factors specific to each location – see CIRIA C680 and CIRIA C737 for further guidance.

## Structural Design – Installation & cover depths

Each AquaCell unit has been designed to have specific loading capacities (see pages 9-12) that define the maximum depth parameters for which they are suitable.

Minimum depth of cover varies according to whether or not the installation will be subject to trafficking by cars/HGVs.

However, in some situations, installations may have to be located with greater cover depths. Reasons may include:

- ④ Deep-running drainage network
- ④ Other buried services running above tank location
- ④ Installation into banked/ sloping ground
- ④ Upper layer of clay preventing infiltration.

The table shows a summary of typical cover depths and installation depths as a guide.

Typical minimum cover depths and maximum installation depths

Location type	Minimum cover depths			
	AquaCell Eco	AquaCell Prime	AquaCell Core	AquaCell Plus
Landscaped/non-trafficked areas	0.3m <sup>b</sup>	0.3m <sup>b</sup>	0.3m <sup>b</sup>	0.3m <sup>b</sup>
Car parks, vehicle up to 12000 kg <sup>a</sup> gross mass	n/a	0.71m	0.75m	0.75m
HA/HGV loading <sup>a</sup>	n/a	n/a	1.2m	1.1m
Maximum installation depths				
Maximum depth to base of unit (Landscaped)	1.5m	3.7m	4.25m <sup>c</sup>	5.08m
Maximum depth to base of unit (Trafficked)	n/a	3.45m	4.1m	4.78m

- (a) For specific advice on cover depths for heavier loadings/HGV applications, contact Wavin Technical Design on 0844 856 5165.
- (b) 0.3 is minimum depth for AquaCell Eco, although 0.5m cover is recommended to prevent accidental damage. If construction plant is to be used on site, extra protection may be needed.
- (c) Allowable maximum depth to base of bottom layer of units is dependent on soil type, angle of shearing resistance, loadings, and groundwater level. The above depths are based on 38° angle of shearing resistance and no groundwater.

The height of any tank should not exceed 2m (5 units). If you require a tank that exceeds this, please contact Wavin Technical Design for guidance:

T: 0844 856 5165 E: [technical.design@wavin.co.uk](mailto:technical.design@wavin.co.uk)

**Minimum cover and maximum installation depths to base of units from ground level, in best soil conditions**

This chart shows how deep each unit can be used for different applications in best soil conditions.

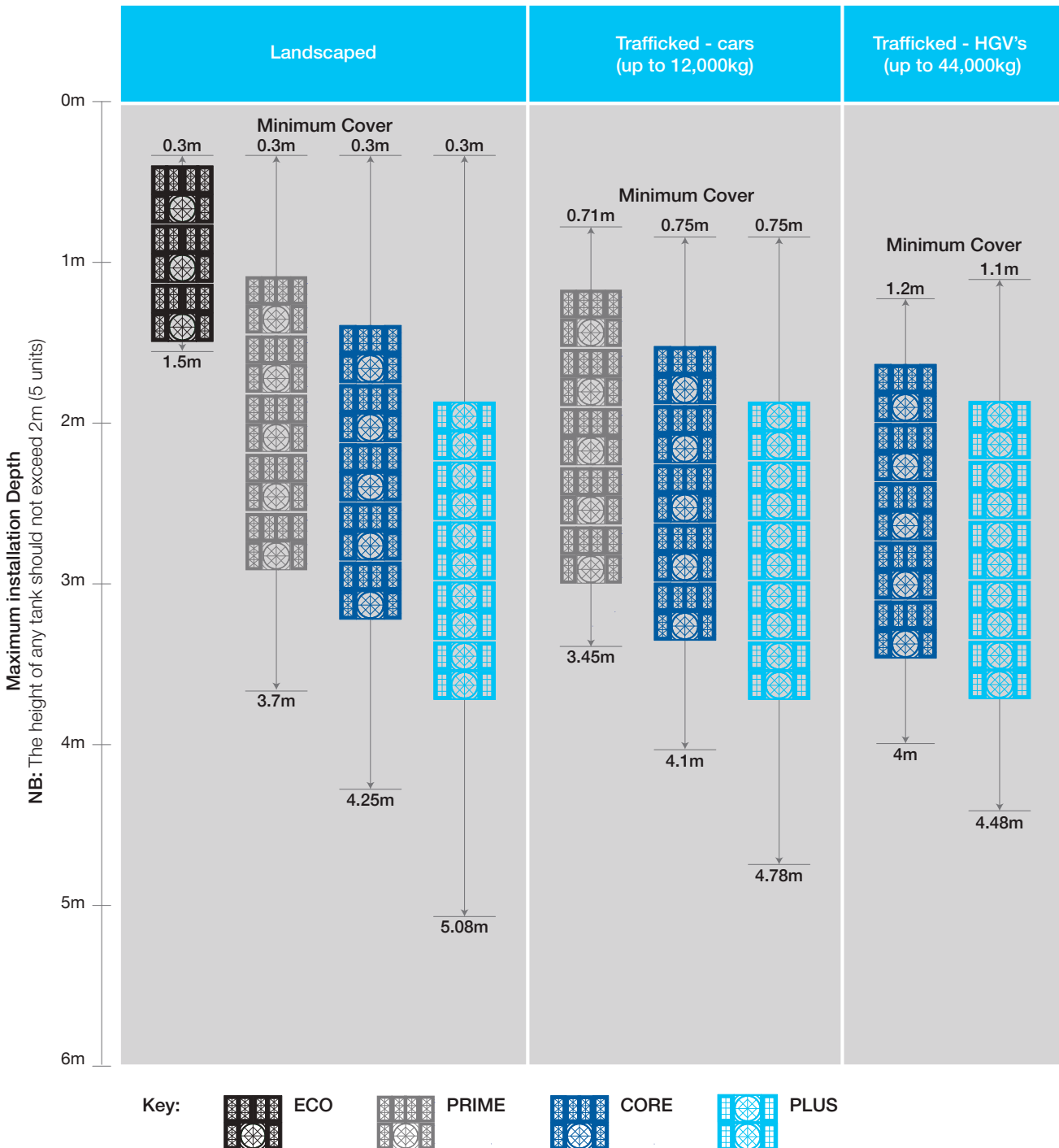

Note: The AquaCell units can also be used in combination with each other, see page 18 for details.

# Design Guidance AquaCell Units

## Mix and match

Although all AquaCell units have identical dimensions, and a high nominal void ratio of 95%, they are manufactured to perform at a range of depths, dependent on soil type, angle of shearing resistance, loading and ground water levels. For optimum performance the units can be mixed and matched (in layers) to value engineer the most effective design (in cost and performance terms) for each installation. For example, in a landscaped application if you needed to install a tank or soakaway that is deeper than 1.5m, you could install layers of AquaCell Prime underneath the AquaCell Eco. See below illustrations showing examples of how the AquaCell units can be mix and matched together. For advice on how to optimise a tank or soakaway design using more than one type of AquaCell please contact Wavin Technical Design.

Note: AquaCell Eco cannot be used directly with AquaCell Plus therefore there must be a layer of either AquaCell Prime or Core between them.

## Typical examples of Mix & Match with AquaCell

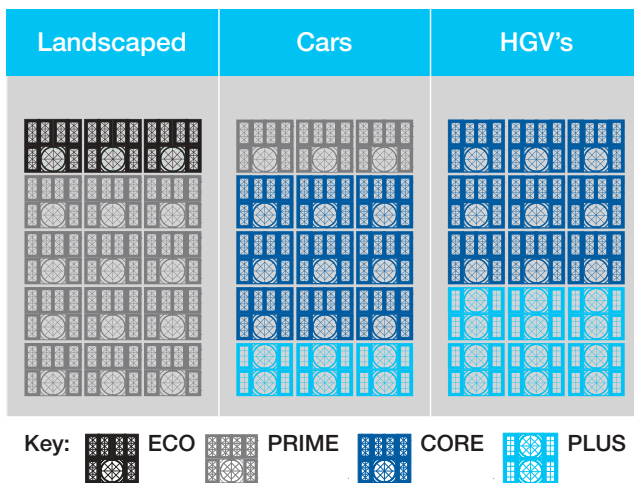

## Brick bonding – for extra stability

When assembling a geocellular structure that comprises two or more layers, it is recommended that AquaCell units are placed in a 'brick-bonded' configuration for extra stability.

This helps minimise continuous vertical joints in the assembly, and gives the structure extra stability.

A significant advantage of AquaCell unit design is that brick bonding placement does not require extra connectors.

All four AquaCell units may be placed in this way, unless inspection channels and cleaning access are required using AquaCell Plus.

AquaCell Plus units incorporate integral inspection channels. These are designed for combined alignment to create viewing tunnels at the base of an assembled structure (see page 13).

## Example of AquaCell being brick bonded

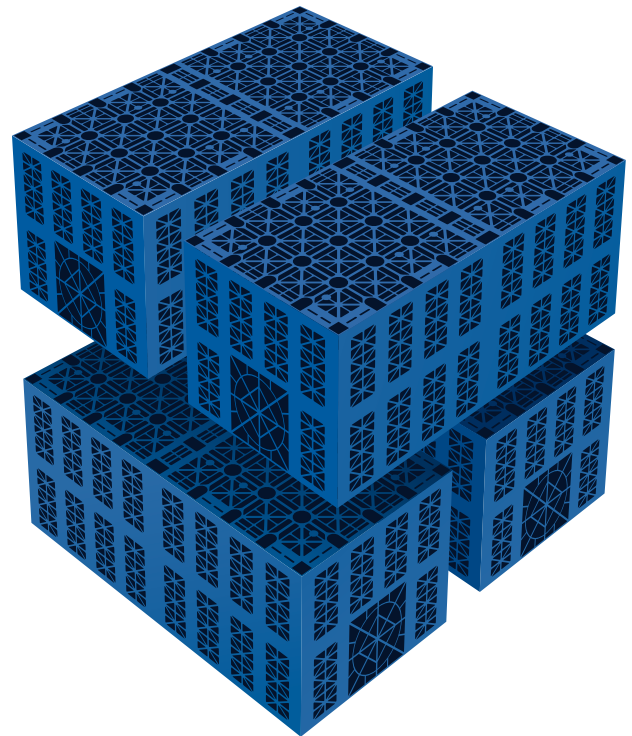

# Installation Guidance

## AquaCell Units

### AquaCell Prime, Core and Plus: Construction Loads

Construction plant such as excavators can impose significant loads on any AquaCell unit. The following guidelines should be observed:

- ⦿ Tracked excavators (not exceeding 21 tonnes weight) should be used to place fill over the AquaCell units when the geotextile or geomembrane wrapping has been completed
- ⦿ At least 300mm of fill should be placed before the excavators or trucks delivering the backfill are allowed to traffic over the installed units
- ⦿ Compaction plant used over the AquaCell units should not exceed 2300kg/metre width. This will allow the compaction of Type 1 sub-base in 150mm layers over the units in accordance with the Specification for Highways Works
- ⦿ All other construction plant should be prevented from trafficking over the system once it is installed and surfacing completed, unless a site specific assessment demonstrates that it is acceptable
- ⦿ In particular cranes should not be used over, or place their outriggers over the system

### AquaCell Eco: Construction Loads

As AquaCell Eco is designed for landscaped and non-loaded applications, certain precautions are recommended on site to prevent damage to the units through excess loading.

#### Manual assembly

Whilst assembling the tank, it may be necessary to walk on top of previously laid AquaCell units. Therefore care should be taken not to damage the edges of the units.

#### Backfilling

When backfilling AquaCell Eco installations:

- ⦿ Machines placing the material must be located OFF the units
- ⦿ Only light compaction should be applied to the material
- ⦿ Backfill with suitable, stone-free, as-dug material
- ⦿ First layer should be 300mm thick before using any compaction plant
- ⦿ NO vibratory mechanism should be used for compacting this first layer
- ⦿ Compaction plant must not exceed 2300kg per metre width

#### Construction traffic on site

Once backfilled, if construction plant (e.g. excavators or loaders) are likely to run over the installation, ensure that:

- ⦿ MINIMUM protective cover should be 500mm well-compacted granular material
- ⦿ Only tracked excavators can be used and MUST NOT weigh more than 14 tonnes.
- ⦿ HGVs MUST NOT run over installed AquaCell Eco units

#### Manual assembly

All ancillaries and adaptors (see pages 36-39) can be used with either the AquaCell Eco, Prime, Core or Plus units, except the 225mm Flange Adaptor (6LB106) which must only be used with AquaCell Prime, Core or Plus.

The 150mm Flange Adaptor (6LB104) should only be used when constructing an air vent on the top surface of an AquaCell Eco unit. The adaptor should not be used to connect inlet pipes to the side of an Eco unit.

# Installation AquaCell Units

## Typical Soakaway Installation Method

### Typical installation procedure

1. Excavate the trench to the required depth ensuring that the plan area is slightly greater than that of the AquaCell units.
2. Lay 100mm bed of coarse sand or non angular granular material, level and compact.
3. Lay the geotextile\* over the base and up the sides of the trench.
4. Lay the AquaCell units parallel with each other. In multiple layer applications, wherever possible, continuous vertical joints should be avoided. AquaCell units can be laid in a 'brick bonded' formation (i.e. to overlap the joints below) – see page 18. For single layer applications use the AquaCell Clips and for multi layers use the AquaCell Clips and the AquaCell Shear Connectors (vertical rods).
5. Fix the Adaptors to the AquaCell units as required and connect pipework.
6. In order to prevent silt from entering the tank, clogging inlet pipework and reducing storage capacity, it is recommended that the Domestic Silt Trap (6LB300) or the standard Silt Trap (6LB600) is installed prior to the inlet pipework – see page 26 for installation guidelines.
7. Wrap and overlap the geotextile covering the entire AquaCell structure.
8. Lay 100mm of coarse sand or non angular granular material between the trench walls and the AquaCell structure and compact.
9. Lay 100mm of coarse sand or non angular granular material over the geotextile and compact.
10. Backfill with suitable material.
11. Rainwater from roof areas may discharge directly into the soakaway but rainwater from car parks must discharge through a catchpit manhole and/or a petrol interceptor.

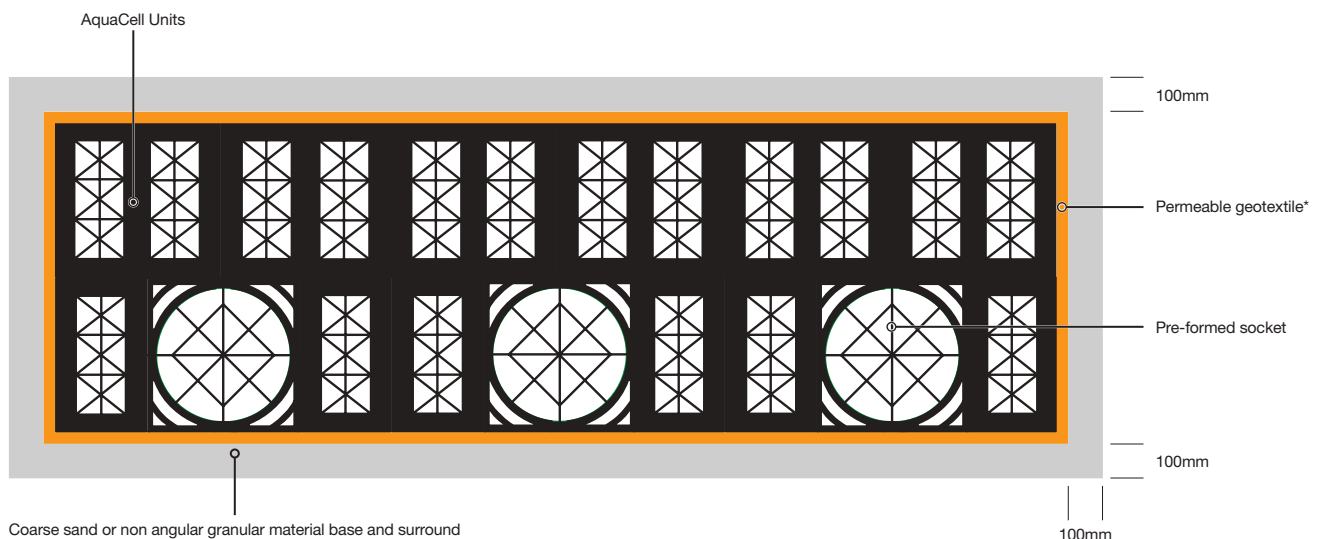

Example shows the use of AquaCell Eco. However, a soakaway can also be installed as shown using either of the other versions of AquaCell units (Prime, Core or Plus) as appropriate.

*\*The geotextile should be selected according to specific site conditions. Typically, however, a 300g non-woven material will be suitable. Specialist advice should be sought if surrounding soil characteristics exhibit a high degree of fines/low infiltration capacity and/or there is a high risk of damage from ground contaminants.*

## Typical Storage Tank Installation Method

### Typical installation procedure

1. Excavate the trench to the required depth ensuring that the plan area is slightly greater than that of the AquaCell units.
2. Lay 100mm bed of coarse sand, level and compact.
3. Lay the geotextile over the base and up the sides of the trench.
4. Lay the geomembrane on top of the geotextile over the base and up the sides of the trench.
5. Lay the AquaCell units parallel with each other. In multiple layer applications, wherever possible, continuous vertical joints should be avoided. AquaCell units can be laid in a 'brick bonded' formation (i.e. to overlap the joints below) – see page 18. For single layer applications use the AquaCell Clips and for multi layers use the AquaCell Clips and the AquaCell Shear Connectors (vertical rods).
6. Wrap the geomembrane around the AquaCell structure and seal to manufacturers recommendations.\*
7. If side connections into the AquaCell units is required, (other than the preformed socket), use the appropriate Flange Adaptor (6LB104 or 6LB106). Fix the flange adaptor to the unit using self-tapping screws. Drill a hole through the Flange Adaptor and connect the pipework. (6LB106 should not be used with AquaCell Eco).
8. In order to prevent silt from entering the tank, clogging inlet pipework and reducing storage capacity, it is recommended that the Domestic Silt Trap (6LB300) or the standard Silt Trap (6LB600) is installed prior to the inlet pipework – see page 22 for installation guidelines.
9. Wrap and overlap the geotextile covering the entire AquaCell structure, to protect the geomembrane.
10. Lay 100mm of coarse sand between the trench walls and the AquaCell units and compact.
11. Lay 100mm bed of coarse sand over the geotextile and compact. Backfill with suitable material. .

NB: A storage tank must be vented, and it is recommended that one vent pipe, 110mm in diameter is provided per 7,500 square metres of impermeable catchment area on a site, see page 22 for design.

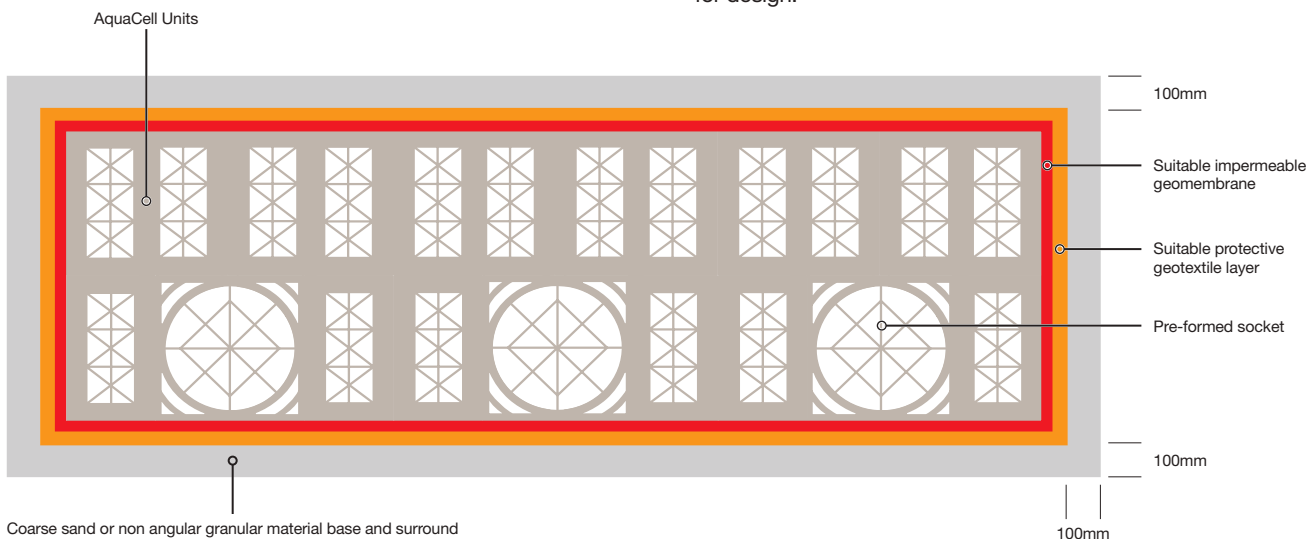

Example shows the use of AquaCell Prime. However, a storage tank can also be installed as shown using any of the other versions of AquaCell units (Eco, Core or Plus) as appropriate.

\*For large scale, deep installations a 1mm thick geomembrane is recommended and joints should be sealed using proprietary welding techniques. For further details contact Wavin Technical Design.

# Installation AquaCell Units

## Silt Trap and Air Vent Termination

### Silt Trap

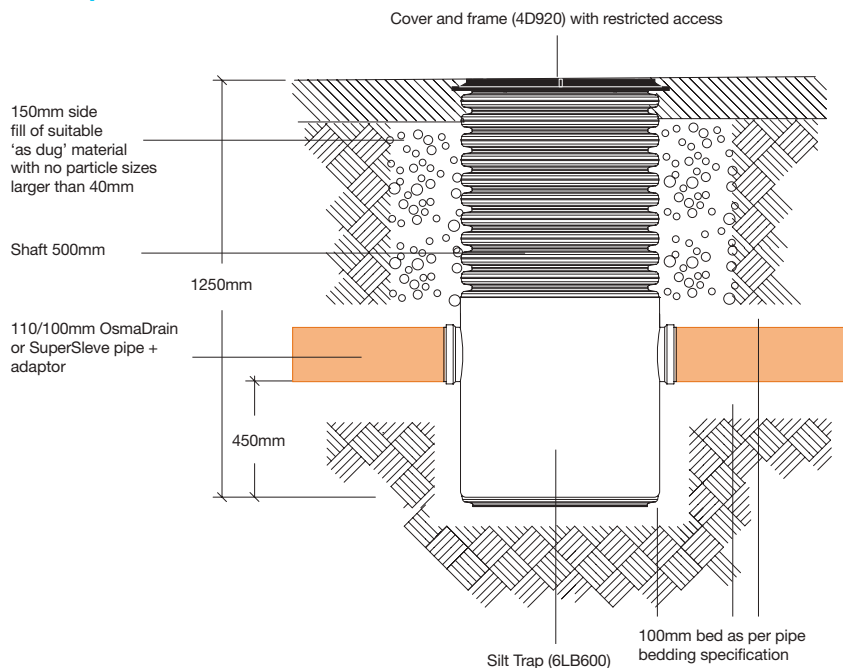

### Typical installation procedure

1. Place the Silt Trap (6LB600) on a minimum of 100mm bed as per pipe bedding specification. Ensure that the trap is as close to the AquaCell unit as possible and in a suitable position to allow pipework connection.
2. Connect the relevant pipework in accordance with standard pipe installation guidelines.
3. Surround the sides of the Silt Trap with 150mm of 'as dug' material, with no particle sizes larger than 40mm.
4. Fit relevant cover and frame.

NOTE: When surrounded by a concrete plinth (150mm x 150mm) the 4D920 Cover and Frame can be used in situations with a loading of up to 50kN (5 tonne).

### Typical Air Vent design

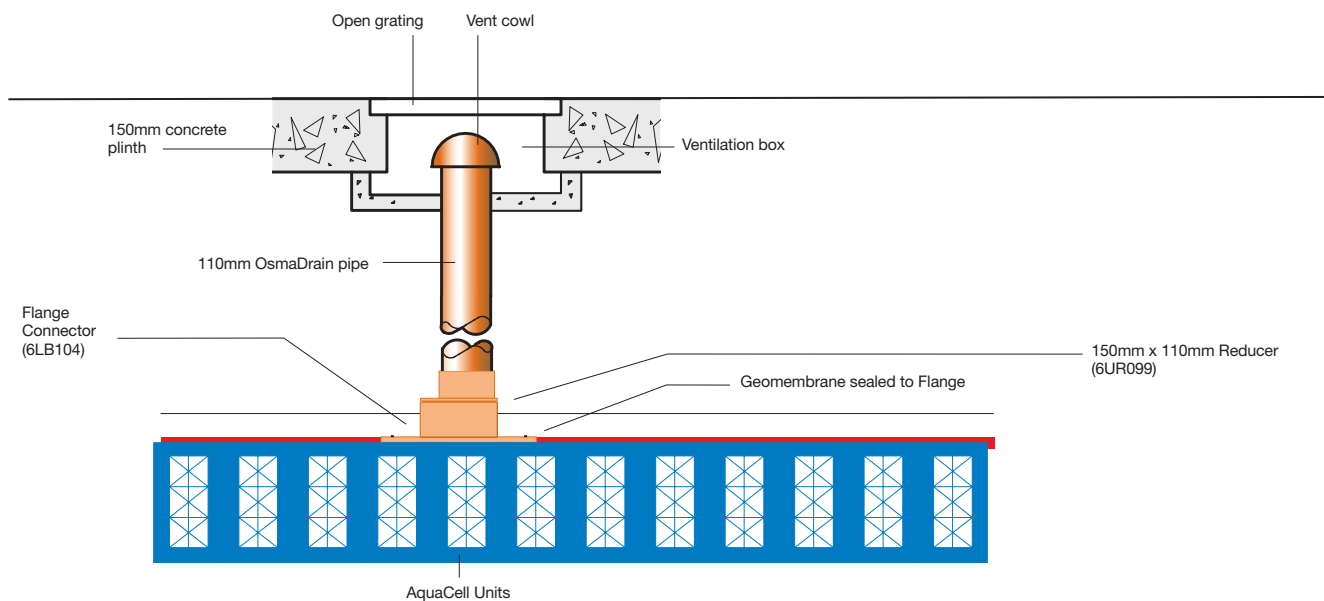

NOTE: It is recommended that all connections and air vent installations in storage applications (using geomembrane) are made using a Flange Adaptor.

Adhesive or double sided tape should be used between the geomembrane and the flange plate to ensure a watertight seal.

NOTE: It is recommended that one vent pipe, 110mm in diameter, is provided per 7,500 square meters of impermeable catchment area on a site. Please contact Wavin Technical Design for further details.

# Typical Details AquaCell Units

## Top Connection for Air Vent

Connect into the top of the AquaCell unit, using Flange Adaptor.

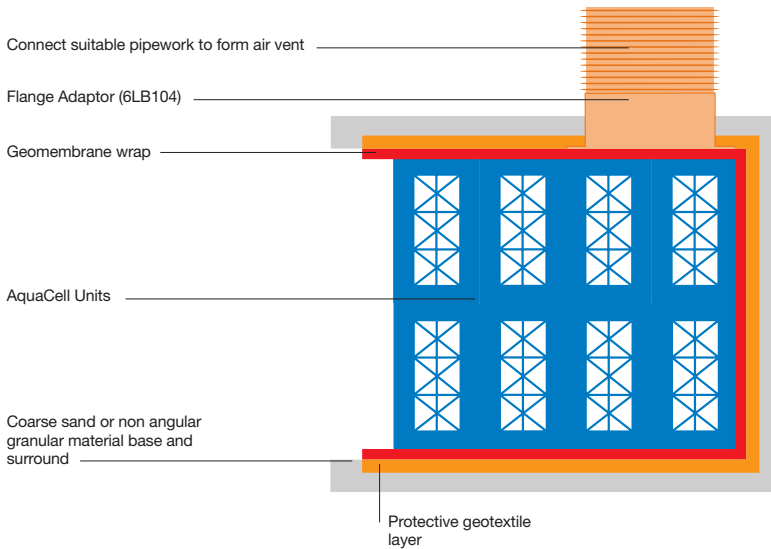

## Typical installation procedure

1. Fix Flange Adaptor to the AquaCell unit with self tapping screws.
2. Cut through the geomembrane.
3. Insert pipework into Flange Adaptor to form air vent.

## Side Connection for Air Vent

Connect into the side of the AquaCell tank unit using standard Reducer.

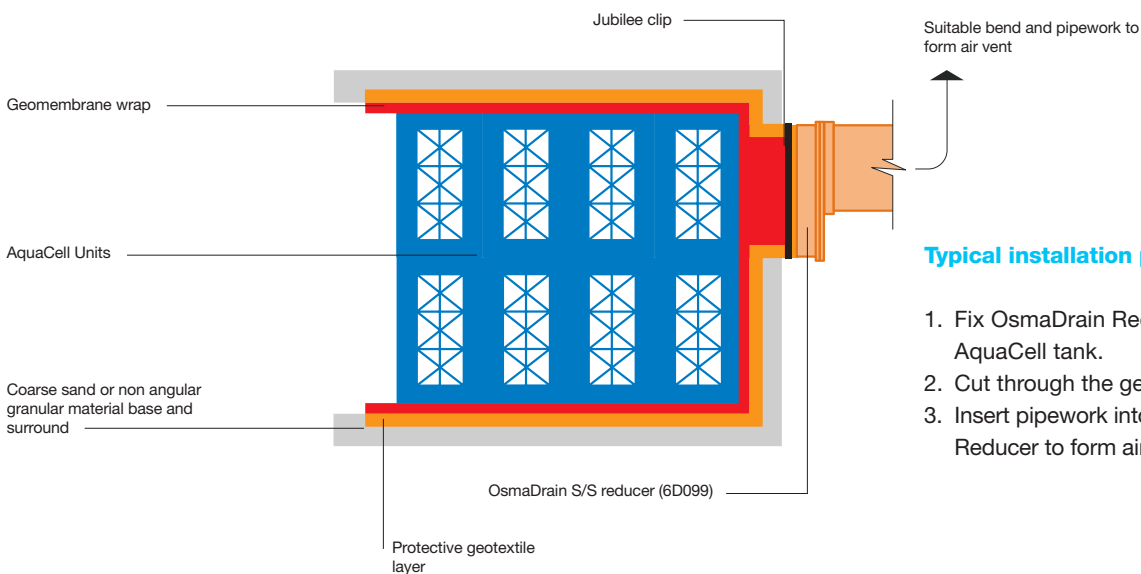

## Typical installation procedure

1. Fix OsmaDrain Reducer to the AquaCell tank.
2. Cut through the geomembrane.
3. Insert pipework into OsmaDrain Reducer to form air vent.

# Typical Details AquaCell Units

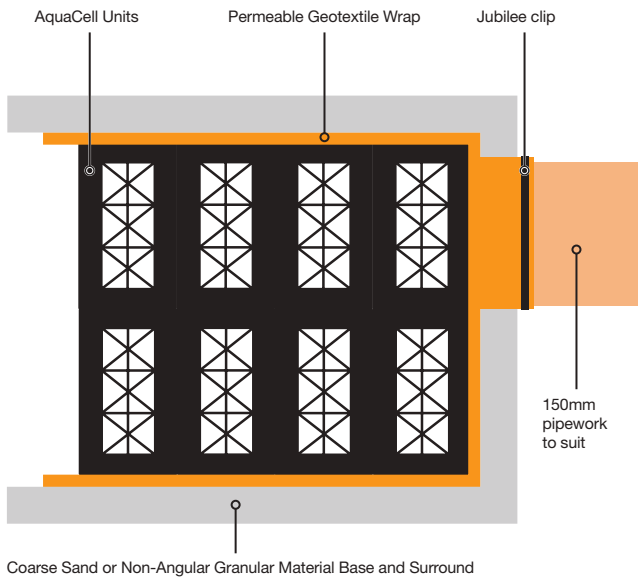

## Connections to AquaCell Units

Connection for soakaway application using either the pre-formed socket (as shown below) or standard adaptors into pre-formed socket\*.

\*NOTE: For pipework other than 160mm OsmaDrain, these adaptors can be used to connect to the following:

- ⦿ 6TW141: TwinWall S/S Adaptor connects to 150mm TwinWall
- ⦿ 6D099: OsmaDrain Adaptor connects to 110mm OsmaDrain
- ⦿ 4D916: OsmaDrain PE Adaptor connects to 160mm OsmaDrain
- ⦿ 6UR141: UltraRib S/S Adaptor connects to 150mm UltraRib
- ⦿ 6D129: OsmaDrain S/S Adaptor connects to 150mm SuperSleeve clay. (Use an appropriate reducer, as required, e.g. 6D099)

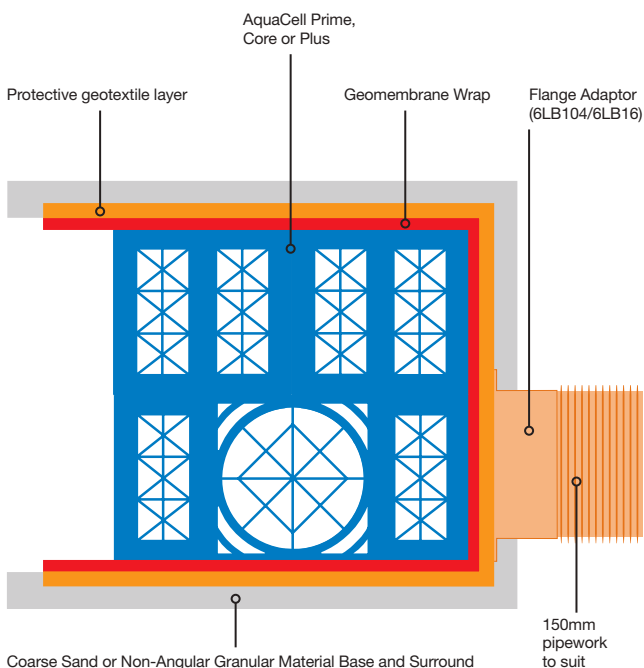

Connection for storage application using Flange Adaptor at points other than pre-formed socket, (for AquaCell Prime, Core or Plus).

## Installation procedure

1. Fix Flange Adaptor to the AquaCell unit with self tapping screws.
2. Cut through the geomembrane.
3. Insert pipework into Flange Adaptor.

\*NOTE: AquaCell Eco is not suitable for side connection using a Flange Adaptor.

## Connection Configurations

The connections shown here in schematic form, are the typical options used to connect AquaCell units to control chambers. They provide a controlled feed into and out of the AquaCell units, and are used for either infiltration or attenuation schemes.

### Manifold connection

Using standard pipes and fittings

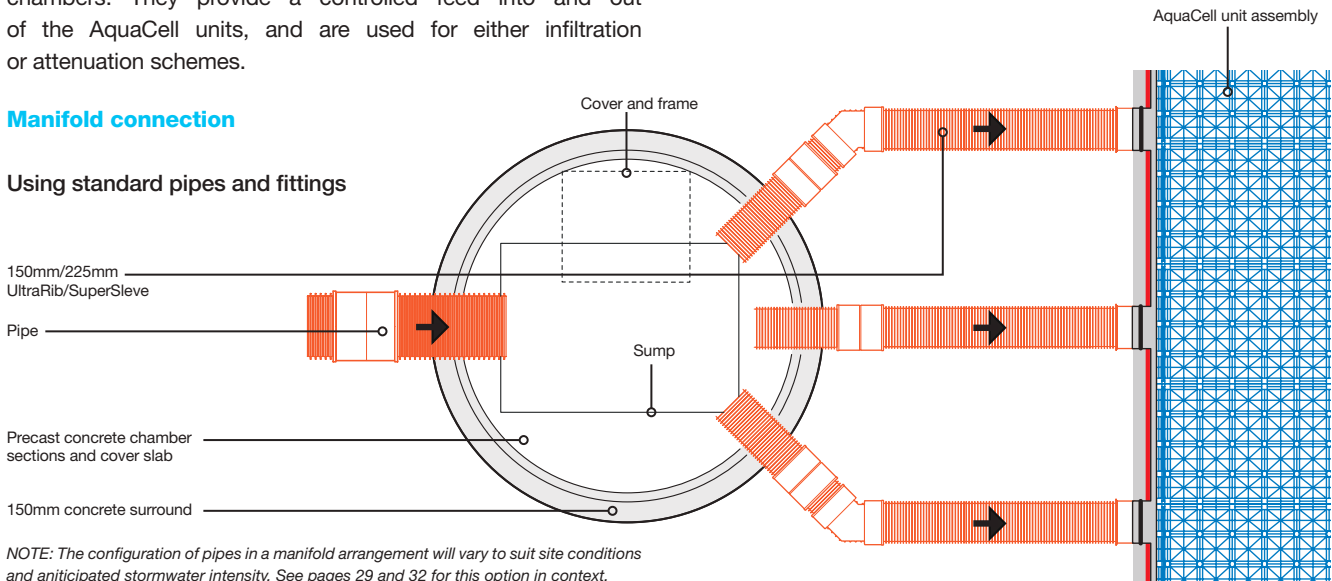

### Box connection

Using AquaCell units for fast water transfer

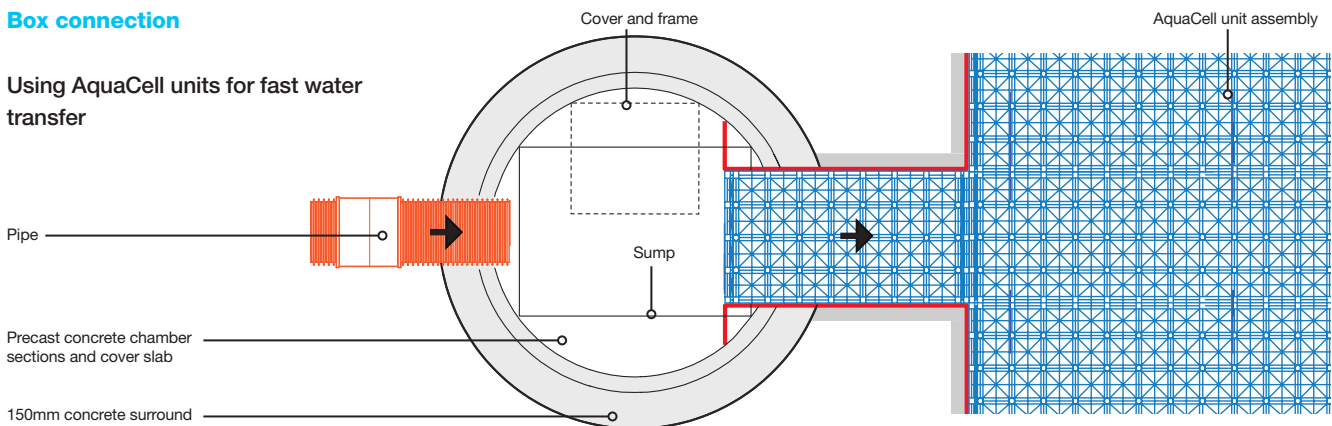

### Central pipe connection

Using standard perforated Wavin TwinWall pipe and fittings

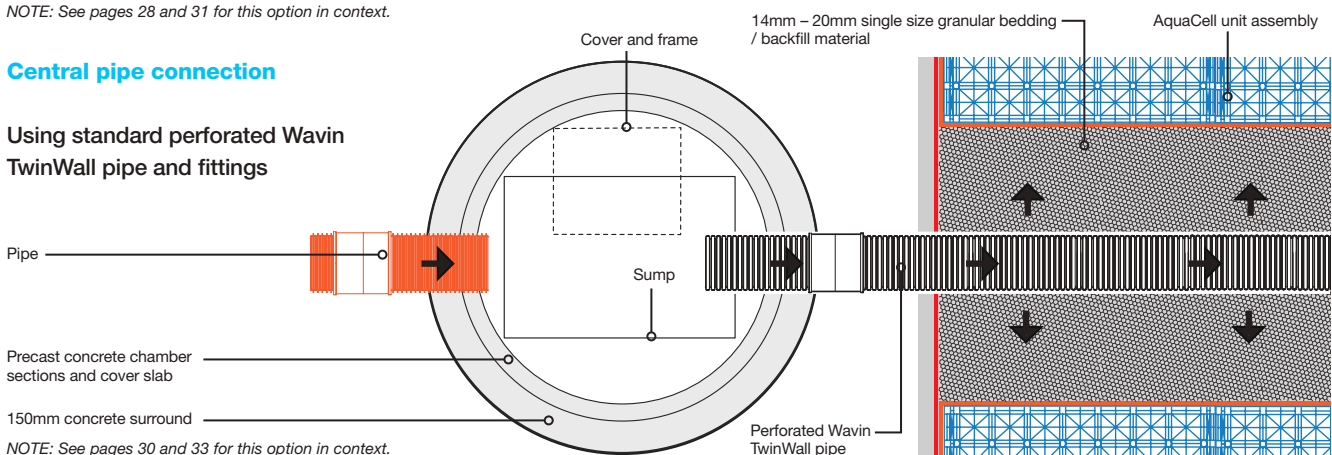

# Typical Details AquaCell Units

## Soakaway – Non-Traffic Loading

### Soakaway

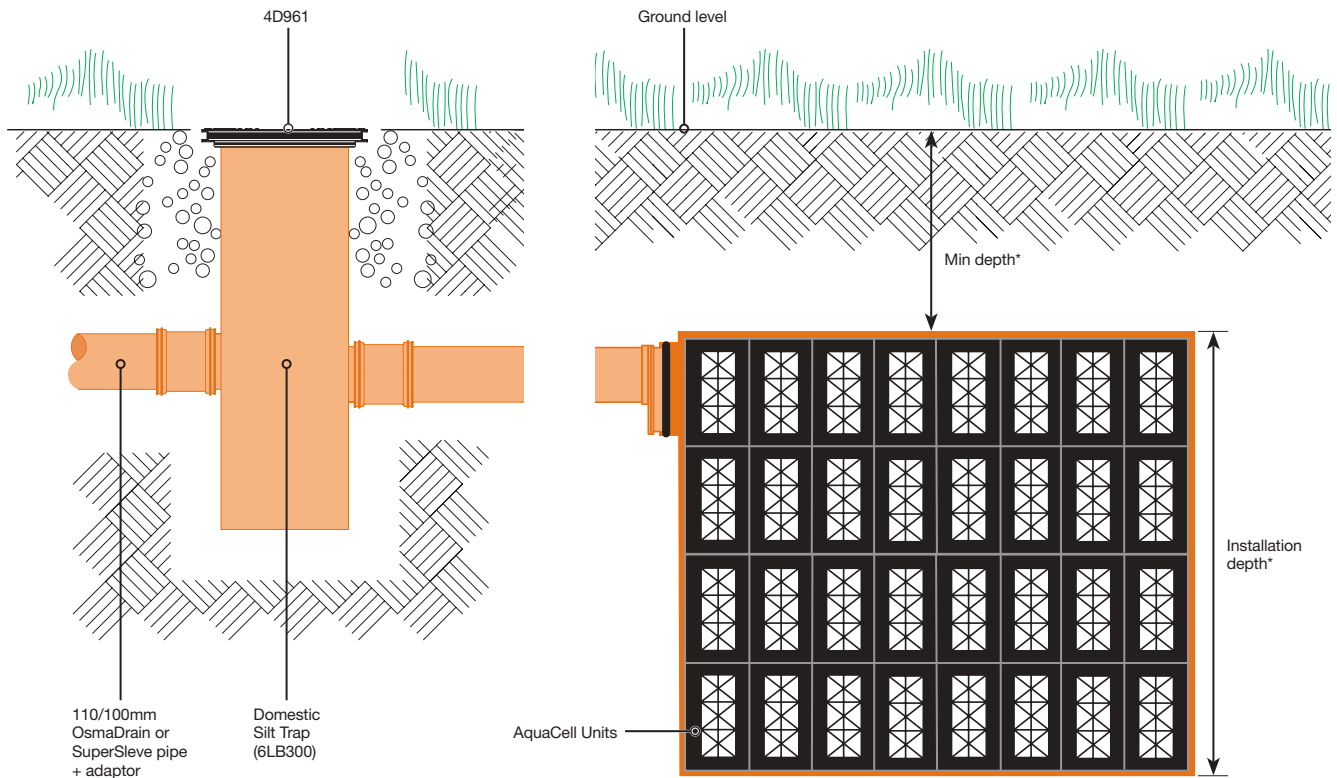

### Trench soakaway

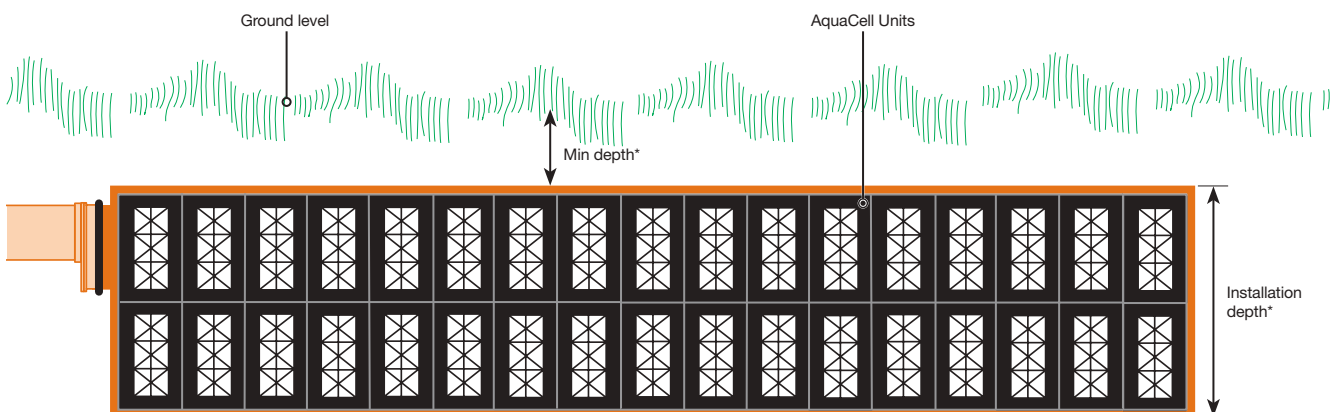

### Notes

1. Soakaways should be sited at least 5m away from the building (Ref BS EN 752-4).
2. The exact size and shape of the soakaways are to be determined once all the necessary calculations have been produced.

\*For information regarding cover depths and installation depths, see page 17.

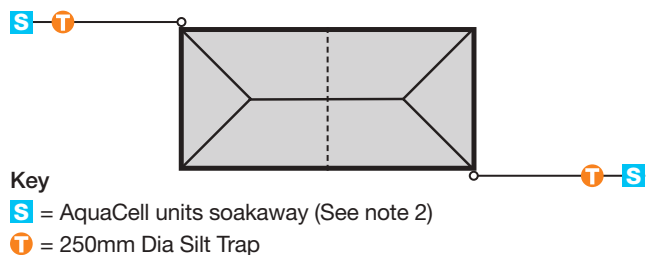

## Soakaway – Traffic Loading

### Soakaway

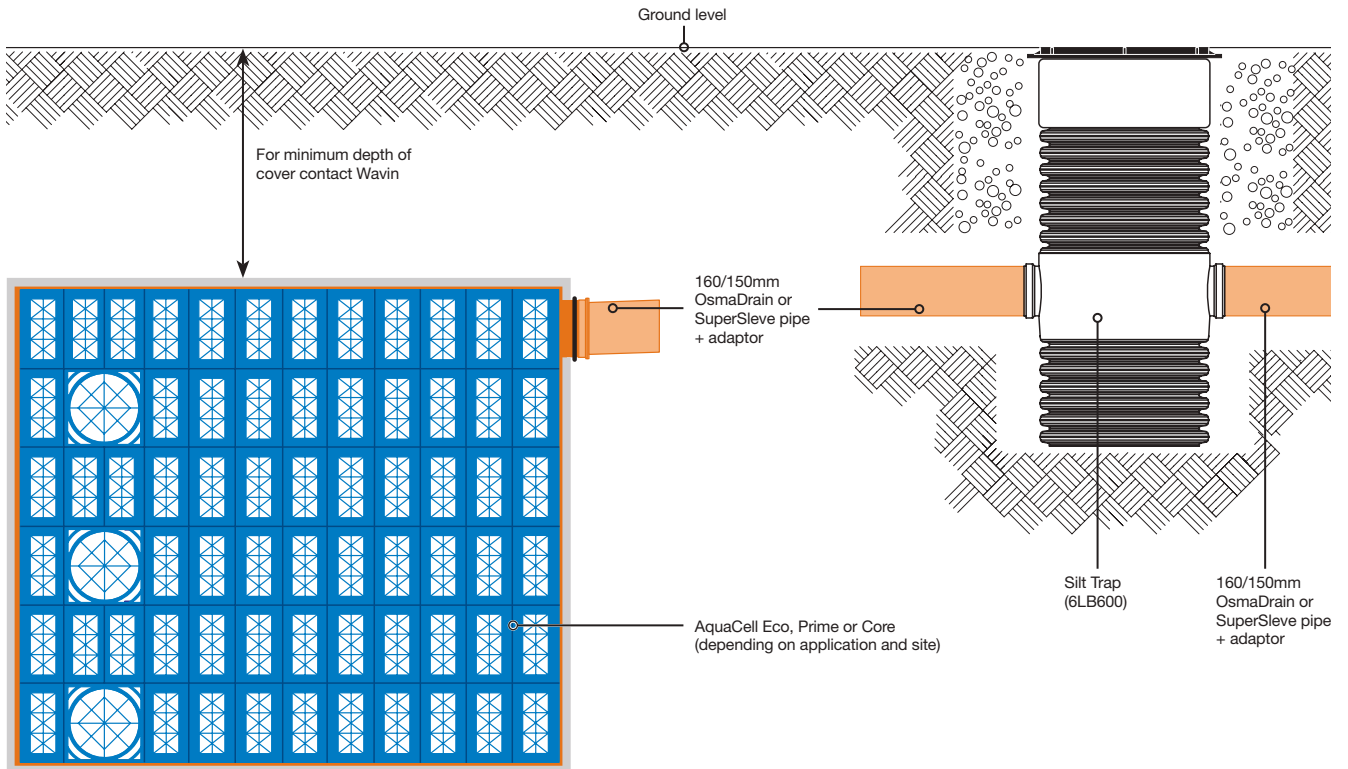

# Typical Details AquaCell Units

## On-Line Storage – Box Feed

### Long section

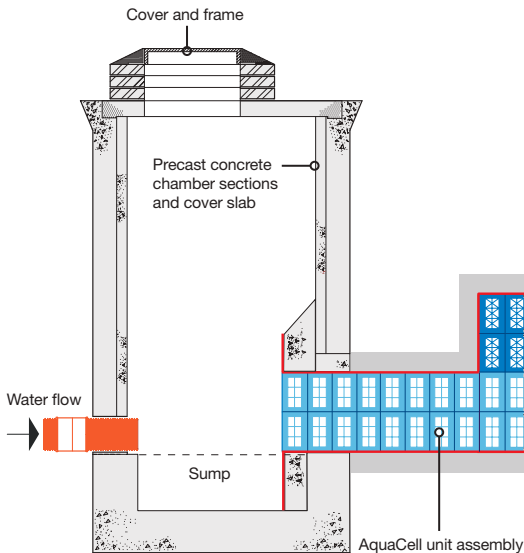

### Typical vent detail

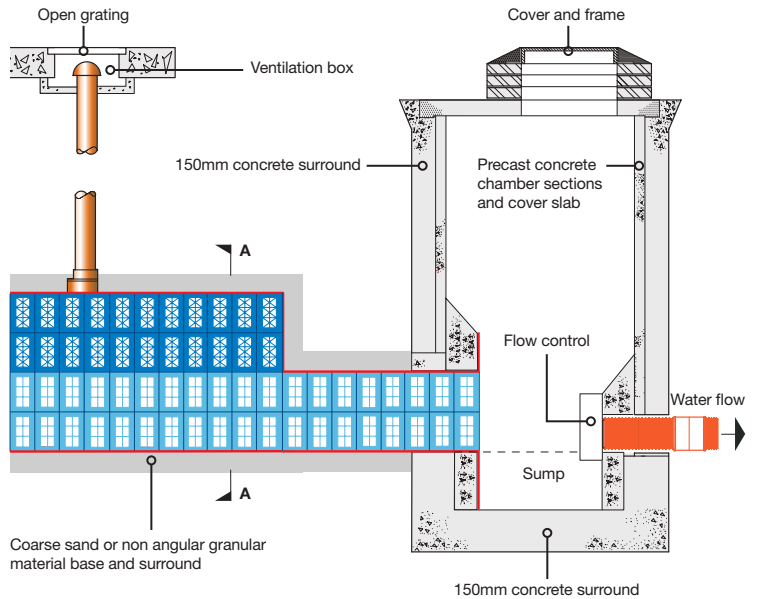

### Plan

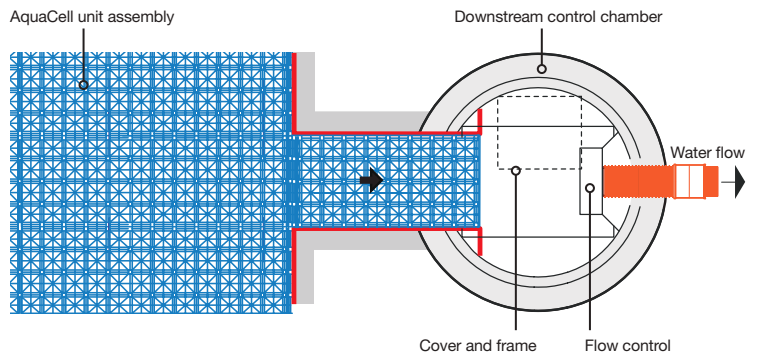
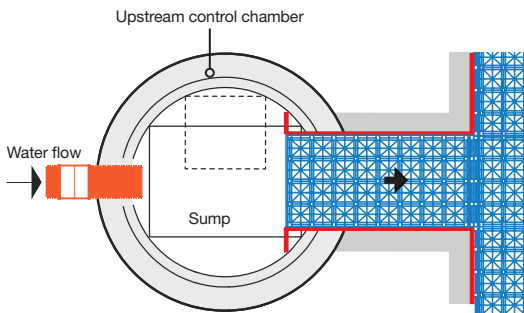

### Cross section A-A

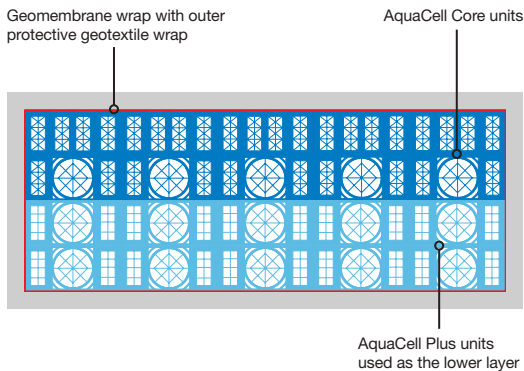

### What happens to the water?

1. The water level in the upstream control chamber rises.
2. Then, during a storm event, the AquaCell storage assembly quickly fills with water via the AquaCell feed connection.
3. After storm event, water flows back out of the AquaCell storage assembly, finding its own level, and into the downstream control chamber.
4. The water then flows through the vortex flow control valve.

## On-Line Storage – Manifold Feed

### Long section

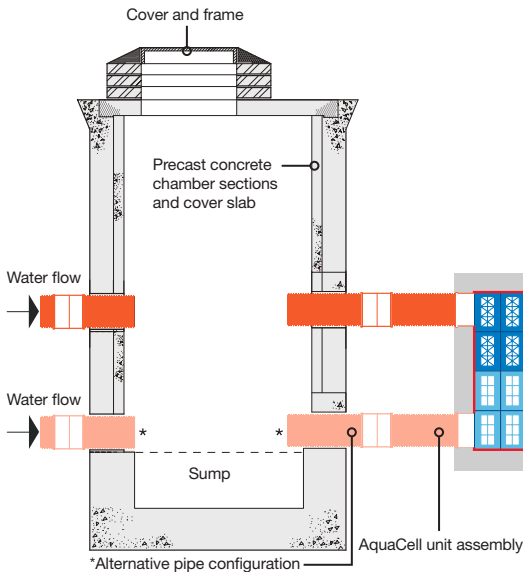

### Typical vent detail

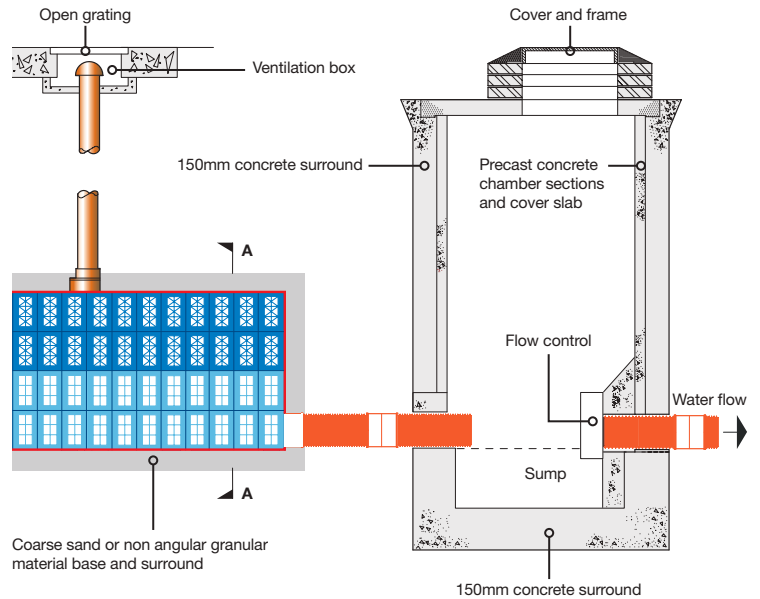

### Plan

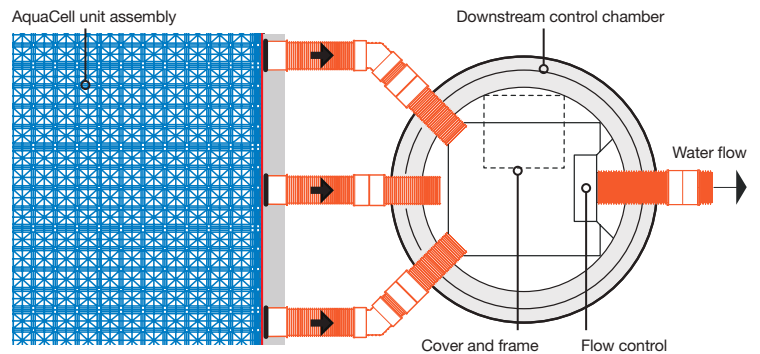
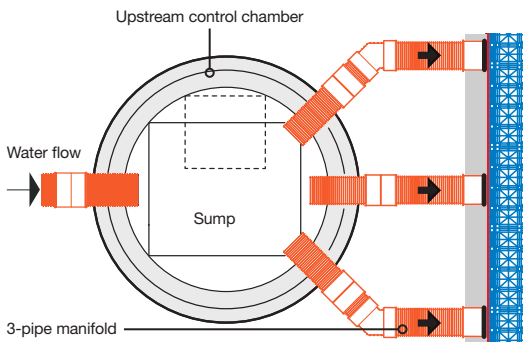

### Cross section A-A

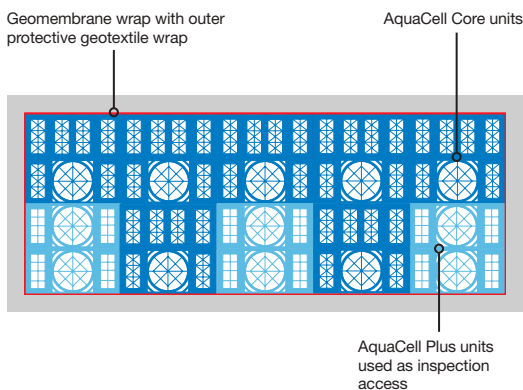

### What happens to the water?

1. The water level in the upstream control chamber rises.
2. During a storm event, the AquaCell storage assembly fills with water via the manifold feed connection.
3. After storm event, water flows back out of the AquaCell storage assembly, finding its own level, and into the downstream control chamber.
4. The water then flows through the vortex flow control valve.

# Typical Details AquaCell Units

## On-Line Storage – Central Pipe Feed

### Long section

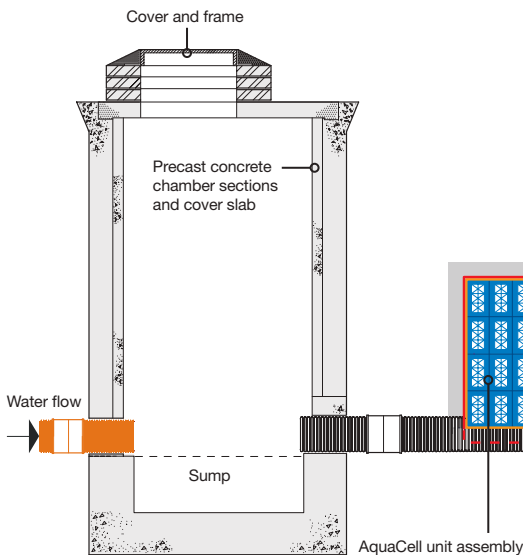

### Typical vent detail

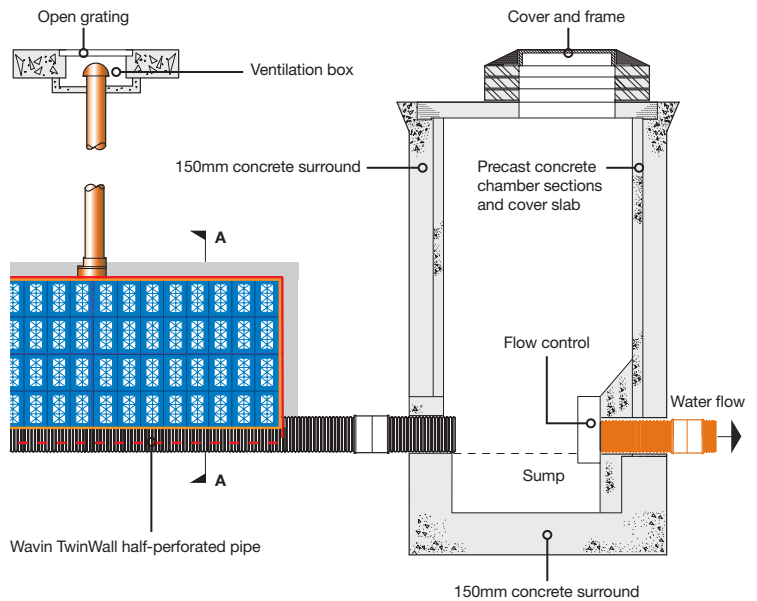

### Plan

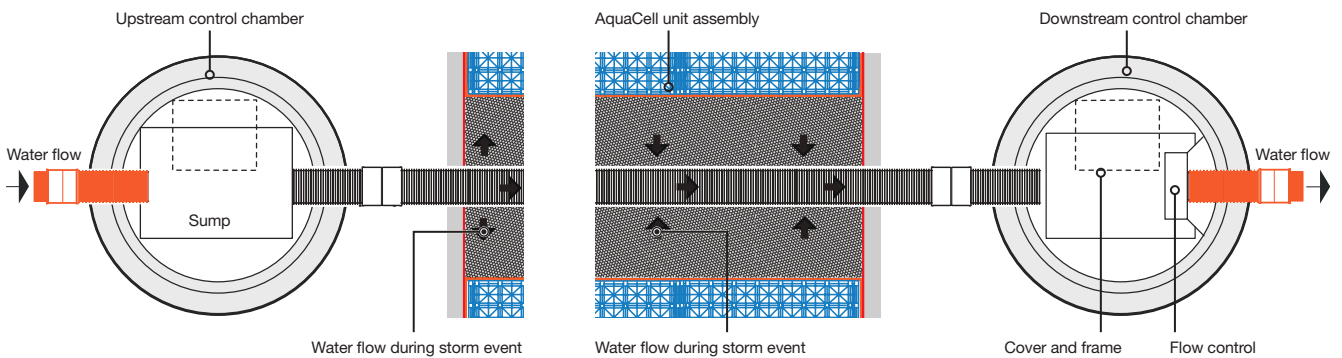

### Cross section A-A

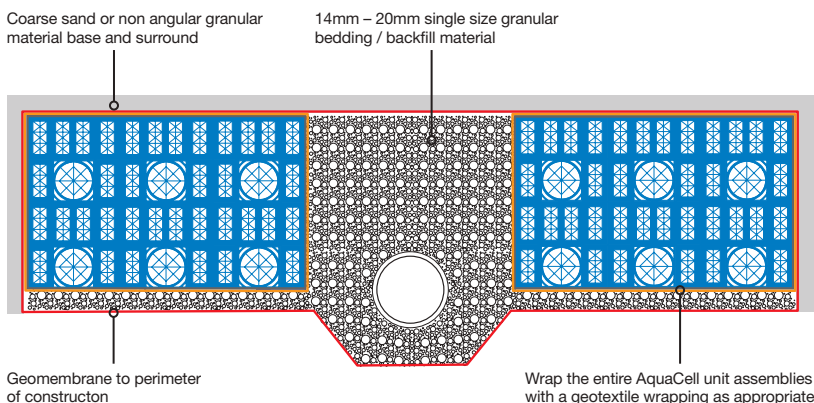

### What happens to the water?

1. The water level in the upstream control chamber rises.
2. AquaCell storage assemblies fill with water via the central pipe connection and percolate's through the granular bedding material.
3. After storm event, water flows back out of the AquaCell storage assemblies, finding its own level, and into the downstream control chamber.
4. The water then flows through the vortex flow control valve.

## Off-Line Storage – Box Feed

### Long section

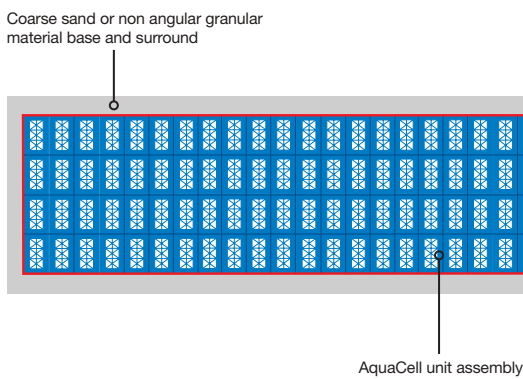

### Typical vent detail

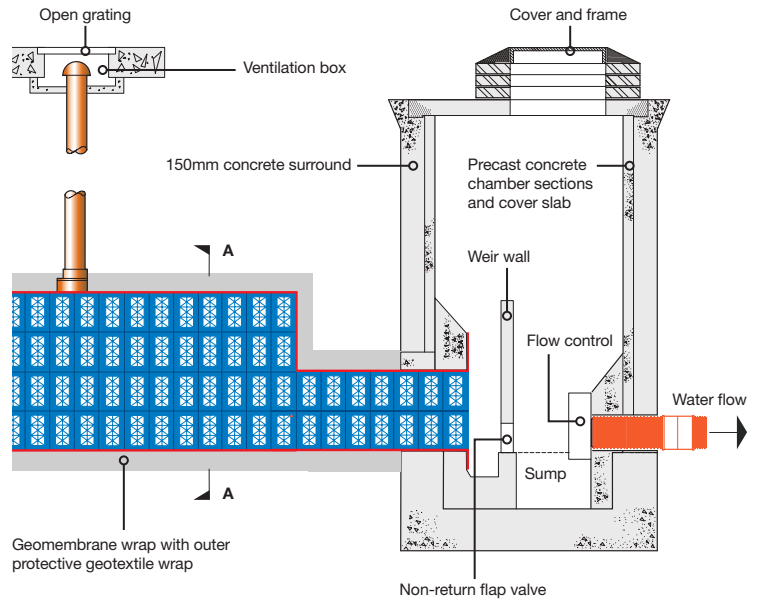

### Plan

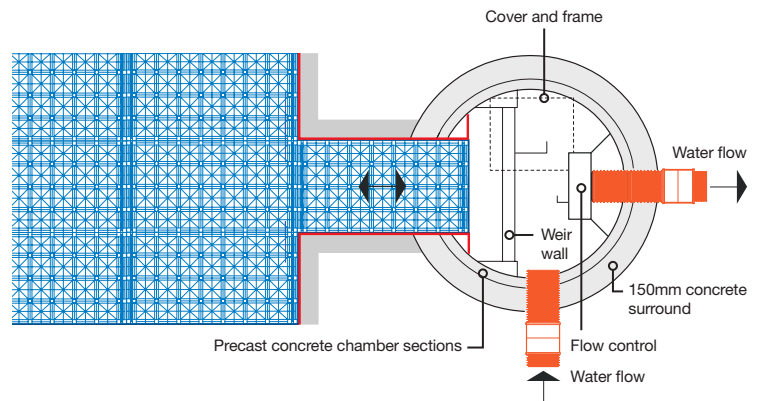
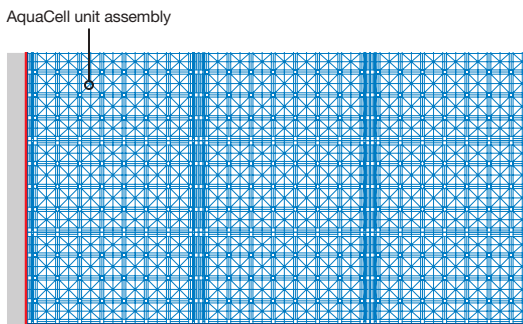

### Cross section A-A

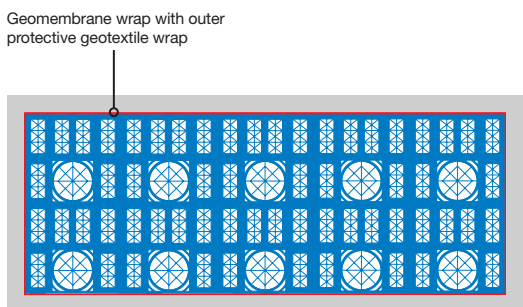

### What happens to the water?

1. Control chamber fills with water, up to the top of the weir wall.
2. The water overflows the weir wall and enters the AquaCell storage assembly via the AquaCell connection.
3. The AquaCell storage assembly fills with water.
4. After storm event, water flows back out of the AquaCell storage assembly, finding its own level, and through the non-return flap valve at the bottom of the weir wall.
5. The water then flows through the vortex flow control valve.

# Typical Details AquaCell Units

## Off-Line Storage – Manifold Feed

### Long section

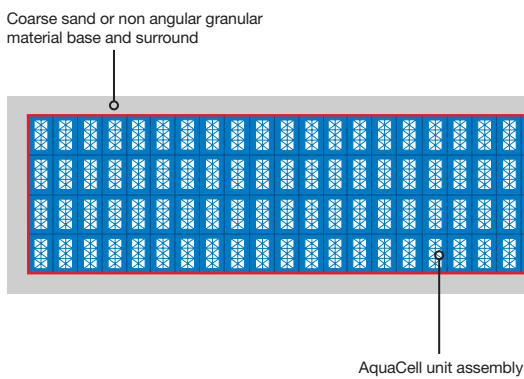

### Typical vent detail

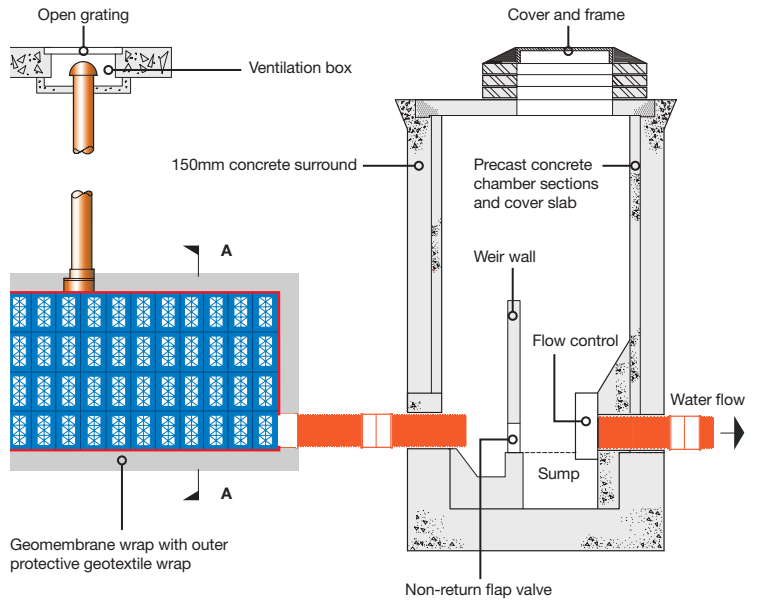

### Plan

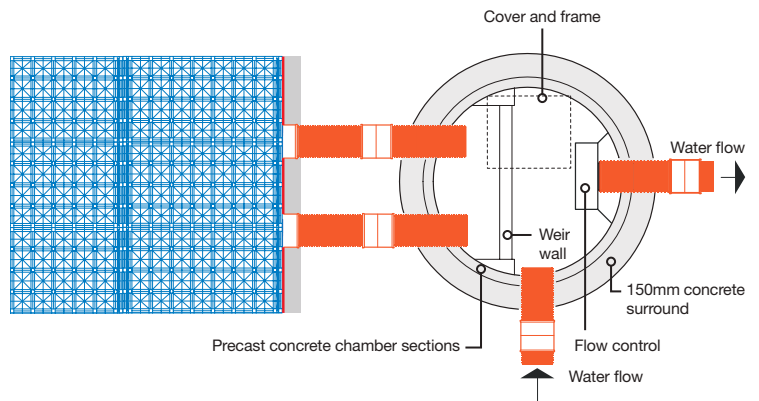
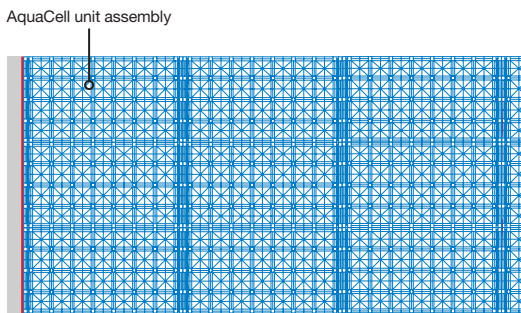

### Cross section A-A

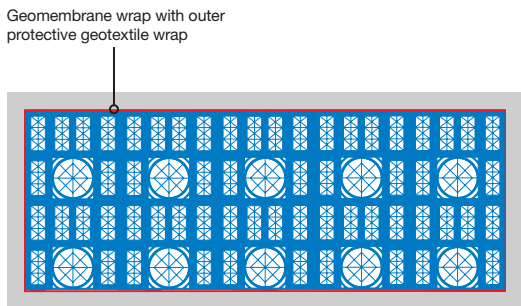

### What happens to the water?

1. Control chamber fills with water, up to the top of the weir wall.
2. The water overflows the weir wall and enters the AquaCell storage assembly via the manifold connection.
3. The AquaCell storage assembly fills with water.
4. After storm event, water flows back out of the AquaCell storage assembly, finding its own level, and through the non-return flap valve at the bottom of the weir wall.
5. The water then flows through the vortex flow control valve.

## Off-Line Storage – Central Pipe Feed

### Long section

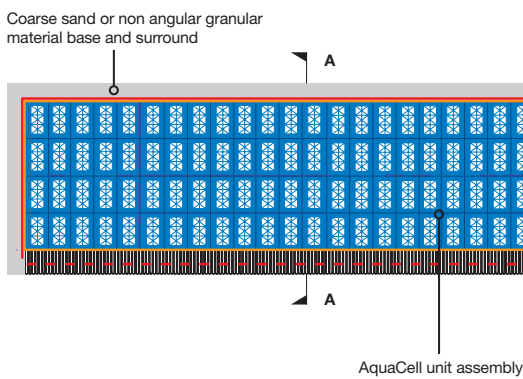

### Typical vent detail

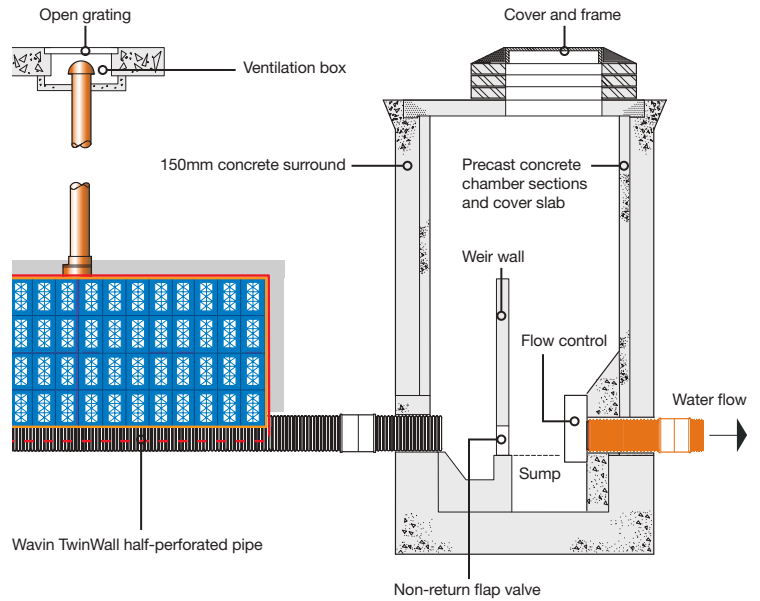

### Plan

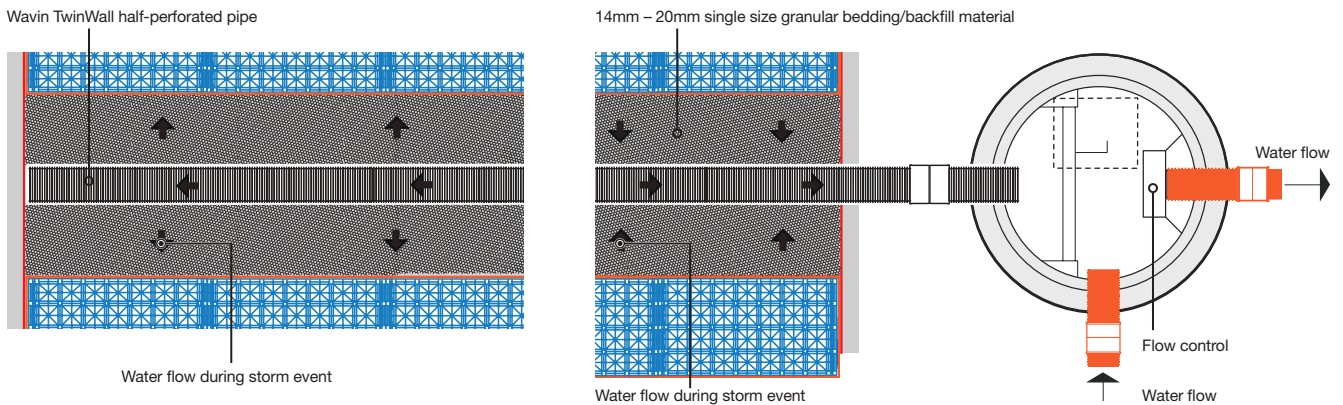

### Cross section A-A

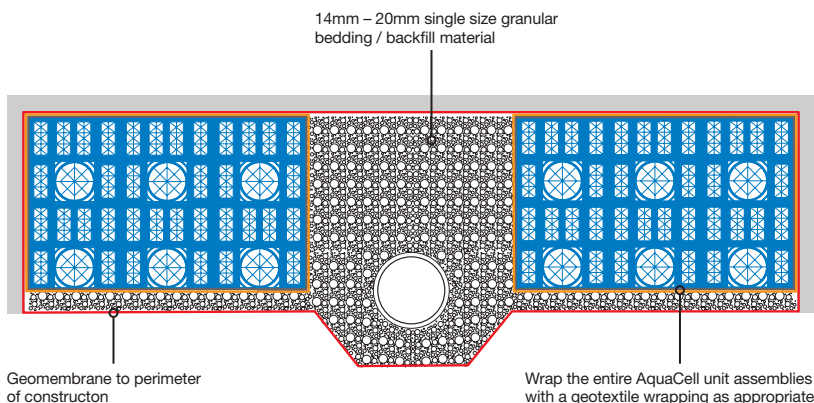

### What happens to the water?

1. Control chamber fills with water, up to the top of the weir wall.
2. The water overflows the weir wall and enters the AquaCell storage assemblies via the central pipe connection and percolate's through the granular bedding material.
3. The AquaCell storage assembly fills with water.
4. After storm event, water flows back out of the AquaCell storage assemblies, finding its own level, and through the non-return flap valve at the bottom of the weir wall.
5. The water then flows through the vortex flow control valve

# Typical Details AquaCell Units

## Soakaway or Storage Tank – With Silt Trap

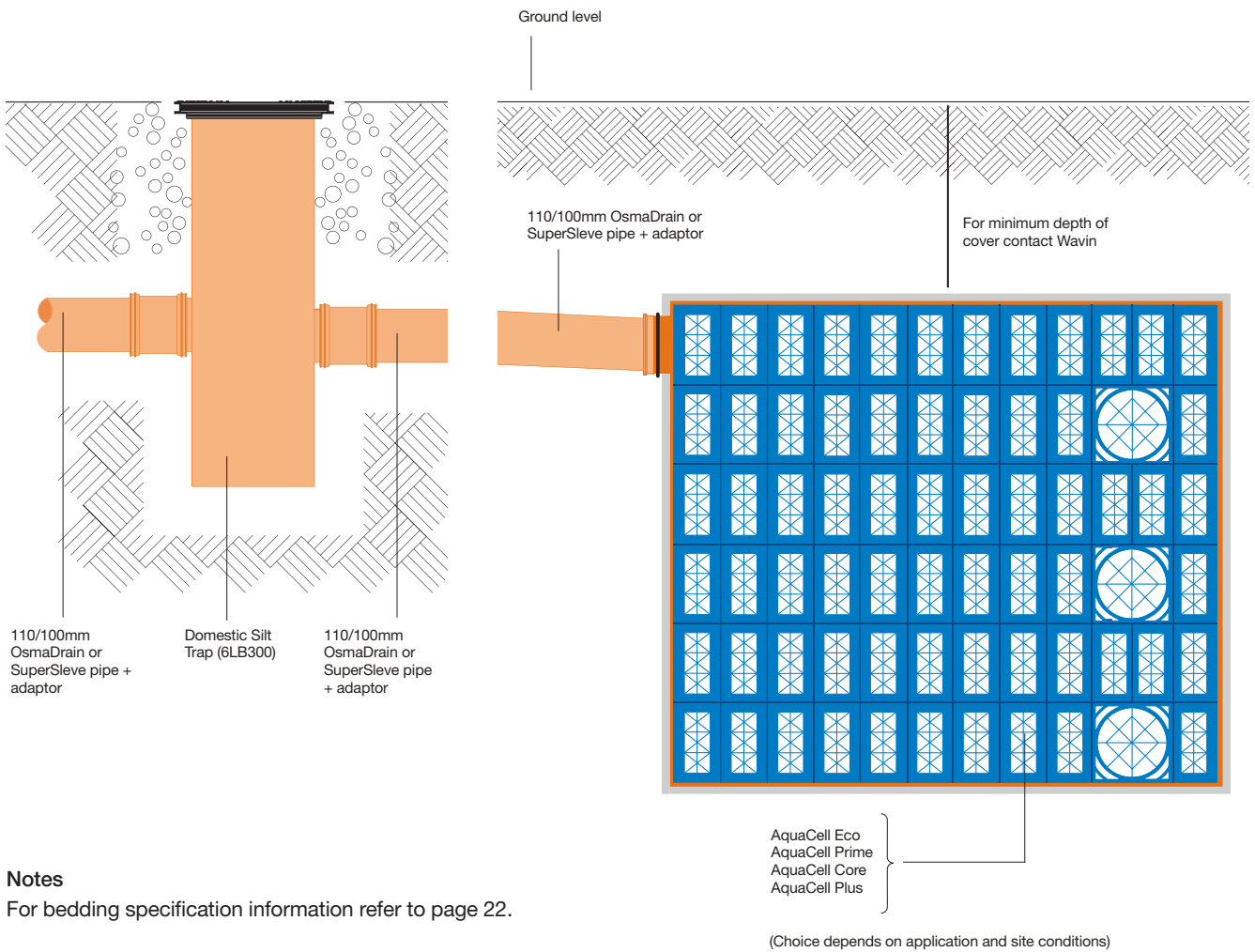

### Notes

For bedding specification information refer to page 22.

The silt trap can be used in conjunction with a soakaway (as shown) or a storage tank.

# Wavin Stormwater Management AquaCell Systems

## To Achieve Optimum Stormwater Management

The Wavin Stormwater Management System represents a combination of specialist expertise and technology from Wavin. This is specifically focused on achieving the optimum solution for each project requiring effective and sustainable management of stormwater.

Such a solution may be entirely based on a tailored combination of our engineered systems.

In other cases, Wavin Stormwater Systems can be integrated with 'soft' SuDS techniques, such as ponds and swales, to help achieve the optimal solution.

## Other Wavin Stormwater Systems

### Oil Separators

A comprehensive range of NS Oil Separators, tested to EN 858 Class 1 standard and complying with PPG-3 legislation for England and Wales.

### Channel Drainage

Environmentally-friendly polyester concrete systems to cover all EN 1433 load classes. With outstanding chemical resistance and low water absorption:

- ⦿ Medium duty range for applications up to C250
- ⦿ Heavy duty range for D400 / F900 application

### Plastic Pervious Paving

High performance, plastic pervious paving system, for use in all types of Sustainable Drainage systems (SuDS).

- ⦿ AquaGrid 50 – for use in landscape projects
- ⦿ AquaGrid 75 – for use in car parking areas

### Flow Control Valves

The Wavin+Mosbaek range of vortex flow control valves are manufactured from stainless steel and are custom-built to meet exact site requirements:

- ⦿ Tornado, Hurricane and Typhoon stainless steel flow control valves with no moving parts of power needs

### Anti-flood Valves

- ⦿ Anti-Flood Valves that comply with EN 13546-1, and Part H1 – Sections 2.8-2.12 of Building Regulations

### Below Ground Water Transportation

Wavin Stormwater installations can draw from an extensive choice of plastic and clay water conveyance systems, including:

- ⦿ OsmaDrain solid wall PVC-U pipe system
- ⦿ Structured wall plastic UltraRib and TwinWall pipe systems
- ⦿ SuperSleve and HepSeal clay pipe systems

Other options include perforated pipe for land drainage: WavinCoil plastic and HepLine clay – and a full range of Wavin Non-Entry Inspection Chambers.

### Rainwater Re-Use

The Wavin Stormwater Water Range can also exploit stored rain water. These reduce the use of potable mains water for non-potable purposes.

## The Wavin Stormwater Service

### Precision and Performance

The Wavin Technical team are ready to contribute to any stormwater management project.

This may be at the very earliest stage – or when initial plans have already been developed. There are no pre-conditions with regards to you requesting Wavin to become involved.

We are ready to:

- ⦿ Originate project design
- ⦿ Comment on an existing design
- ⦿ Help validate a specification – or, where we see an opportunity to do so, to suggest how it may be enhanced
- ⦿ Check, clarify and confirm maximum cost-efficiency, performance capability and regulatory compliance

This involvement is a core part of the Wavin principle. It extends beyond the systems and components.

To discuss your stormwater management project, call 0844 856 5161 or email [technical.design@wavin.co.uk](mailto:technical.design@wavin.co.uk).

# Product Details

## Supplementary Items

### Silt Trap – Domestic – for non loaded applications

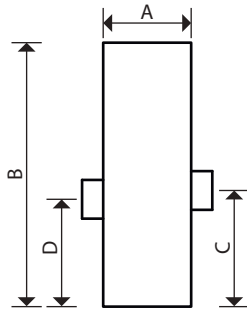

#### Domestic Silt Trap

- 250mm x 750mm depth
- With 110mm diameter inlet and outlet spigots
- For use with the 4D961 cover and frame

Material: PVC-U

Nominal Size (mm)	Part Number	Dimensions (mm)			
		A	B	C	D
-	6LB300	250	750	330	305

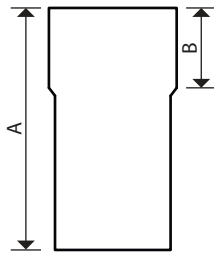

#### Extension Piece for 6LB300

- 250mm x 500mm depth (effective length = 335mm)

Material: PVC-U

Nominal Size (mm)	Part Number	Dimensions (mm)	
		A	B
-	6LB301	500	165

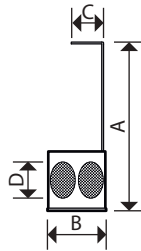

#### Silt Trap Bucket for 6LB300

- 200mm x 210mm depth

Material: PVC-U/Polypropylene

Nominal Size (mm)	Part Number	Dimensions (mm)			
		A	B	C	D
-	6LB302	597	208	114	127.5

### Silt Trap – Trafficked

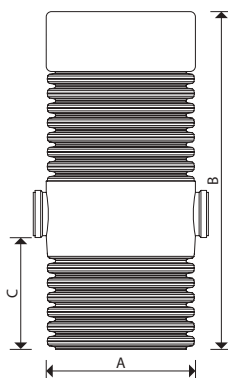

#### Silt Trap

- 500mm diameter x 1.25m depth
- 160mm diameter inlet and outlets

Material: Polypropylene

Nominal Size (mm)	Part Number	Dimensions (mm)		
		A	B	C
-	6LB600	500	1250	450

## Ancillaries

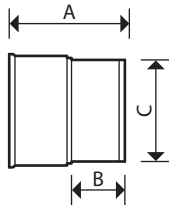

### S/S Adaptor

- 6UR socket x 160mm BS EN 1401 spigot

Material: PVC-U

Nominal Size (mm)	Part Number	Dimensions (mm)		
		A	B	C
150	6UR141	180	84	160

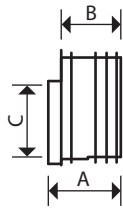

### S/S Level Invert Reducer

- To 110mm OsmaDrain spigot

Material: PVC-U

Nominal Size (mm)	Part Number	Dimensions (mm)		
		A	B	C
150x110	6UR099	115	95	111

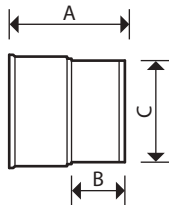

### S/S Adaptor

- 6TW socket x 160mm BS EN 1401 spigot

Material: PVC-U

Nominal Size (mm)	Part Number	Dimensions (mm)		
		A	B	C
150	6TW141	180	84	160

# Product Details

## AquaCell Systems

### Ancillaries

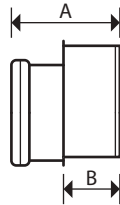

#### S/S Level Invert Reducer

- To 110 OsmaDrain

Material: PVC-U

Nominal Size (mm)	Part Number	Dimensions (mm)	
		A	B
160	6D099	127	70

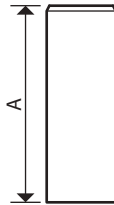

#### P/E Adaptor

- 160mm spigot connection

Material: PVC-U

Nominal Size (mm)	Part Number	Dimensions (mm)
		A
160	4D916	325

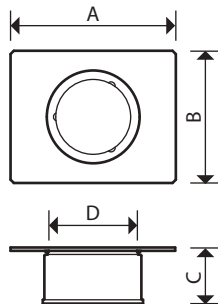
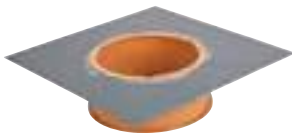

#### Flange Adaptor

- 6UR socket for connection of UltraRib to infiltration unit at positions other than preformed opening
- 9UR socket for connection of UltraRib to infiltration unit (can only be used with AquaCell Prime, Core and Plus)

Material: PVC-U

Nominal Size (mm)	Part Number	Dimensions (mm)			
		A	B	C	D
150	6LB104	300	300	100	160.3
225	6LB106	500	400	120	226.5

## Spares



### AquaCell Clip

- For jointing all AquaCell units horizontally

Material: Polypropylene

Nominal Size (mm)	Part Number
–	6LB105



### AquaCell Shear Connector

- For jointing all AquaCell units vertically

Material: Polypropylene

Nominal Size (mm)	Part Number
–	6LB102

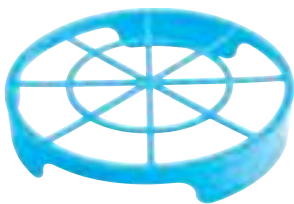

### AquaCell Plus End Cap

- For blocking off unused inlets/outlets

Material: Polypropylene

Nominal Size (mm)	Part Number
–	6LB201

Discover our broad portfolio at  
**[www.wavin.co.uk](http://www.wavin.co.uk)**



**Water management | Plumbing and heating | Waste water drainage  
Water and gas distribution | Cable ducting**

**Wavin Limited**  
Registered Office  
Edlington Lane  
Doncaster | DN12 1BY  
Tel. 0844 856 5152  
[www.wavin.co.uk](http://www.wavin.co.uk) | [info@wavin.co.uk](mailto:info@wavin.co.uk)

© 2016 Wavin Limited

Wavin operates a programme of continuous product development, and therefore reserves the right to modify or amend the specification of their products without notice. All information in this publication is given in good faith, and believed to be correct at the time of going to press. However, no responsibility can be accepted for any errors, omissions or incorrect assumptions. Users should satisfy themselves that products are suitable for the purpose and application intended.

For further product information visit: [wavin.co.uk](http://wavin.co.uk)



**CONNECT TO BETTER**

## Guidance Note 1 – Typical Soakaway Installation Method

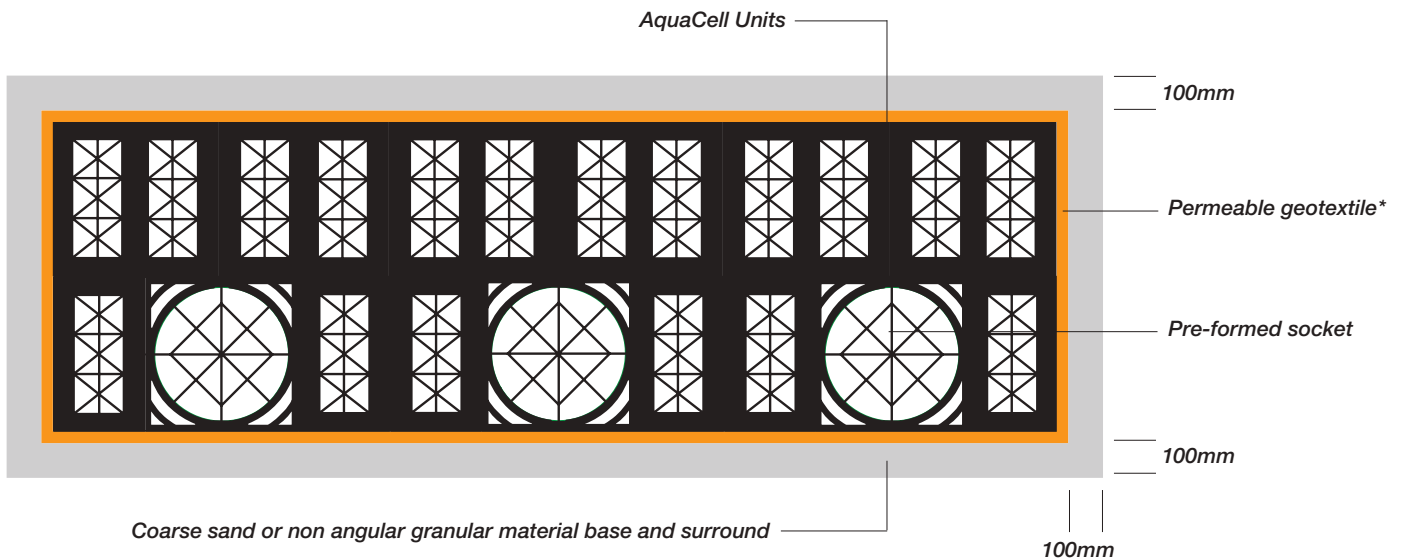

Example shows the use of AquaCell Eco. However, a soakaway can also be installed as shown using either of the other versions of AquaCell units (Prime, Core or Plus) as appropriate.

\* The geotextile should be selected according to specific site conditions. Typically, however, a 300g non-woven material will be suitable. Specialist advice should be sought if surrounding soil characteristics exhibit a high degree of fines/low infiltration capacity and/or there is a high risk of damage from ground contaminants.

### Typical Installation Procedure

1. Excavate the trench to the required depth ensuring that the plan area is slightly greater than that of the AquaCell units.
2. Lay 100mm bed of coarse sand or non angular granular material, level and compact.
3. Lay the geotextile\* over the base and up the sides of the trench.
4. Lay the AquaCell units parallel with each other. In multiple layer applications, wherever possible, continuous vertical joints should be avoided. AquaCell units can be laid in a 'brick bonded' formation (i.e. to overlap the joints below). For single layer applications use the AquaCell Clips and for multi layers use the AquaCell Clips and the AquaCell Shear Connectors (vertical rods).
5. Fix the Adaptors to the AquaCell units as required and connect pipework.
6. In order to prevent silt from entering the tank, clogging inlet pipework and reducing storage capacity, it is recommended that the Domestic Silt Trap (6LB300) or the standard Silt Trap (6LB600) is installed prior to the inlet pipework.
7. Wrap and overlap the geotextile covering the entire AquaCell structure.
8. Lay 100mm of coarse sand or non angular granular material between the trench walls and the AquaCell structure and compact.
9. Lay 100mm of coarse sand or non angular granular material over the geotextile and compact.
10. Backfill with suitable material.
11. Rainwater from roof areas may discharge directly into the soakaway but rainwater from carparks must discharge through a catchpit manhole and/or a petrol interceptor.